

**DNA3500-DNA3750-DNA3800**

**DNA4000-DNA5000**

**IP NVR Appliance**



## Installation and Operations Manual

Model Number: DNA3500, DNA3750,  
DNA3800, DNA4000, DNA5000

Description: NVR IP Video Recording and  
Management Software with IVS

# **DNA Network Video Recorder User's Manual**

**V 5.2.0**

# Table of Contents

1	Features and Specifications .....	1
1.1	Overview.....	1
1.2	Features.....	1
1.3	Specifications.....	2
1.3.1	DNA 3U NVR Series .....	2
1.3.2	DNA 4K 2U NVR Series .....	4
1.3.3	DNA 4K S2 2U NVR Series .....	7
1.3.4	DNA 4K 3U NVR Series .....	10
1.3.5	DNA 4K S2 3U NVR Series .....	11
1.3.6	DNA 4U NVR Series .....	13
2	Front Panel and Rear Panel.....	17
2.1	Front Panel.....	17
2.1.1	DNA 3U NVR / DNA 4K 3U NVR/ DNA 4K S2 3U NVR Series .....	17
2.1.2	DNA 4K 2U NVR/ DNA 4K S2 2U NVR Series .....	19
2.1.3	DNA 4U NVR Series .....	22
2.2	Rear Panel .....	24
2.2.1	DNA 3U NVR Series .....	24
2.2.2	DNA 4K 2U/DNA 4K S2 2U NVR Series.....	24
2.2.3	DNA 4K 3U NVR Series .....	26
2.2.4	DNA 4K S2 3U NVR Series .....	27
2.2.5	DNA 4U NVR Series .....	28
2.3	Alarm Connection.....	29
2.3.1	Alarm input and output details.....	29
2.3.1.1	DNA 3U NVR /DNA 4K 3U/DNA 4K S2 3U Series .....	29
2.3.1.2	DNA 4K 2U/DNA 4K S2 2U Series .....	30
2.3.1.3	DNA 4U NVR Series .....	31
2.3.2	Alarm Input and Output Port.....	31
2.3.3	Alarm Output Port.....	32
2.3.4	Alarm relay specifications .....	32
2.4	Remote Control .....	32
2.5	Mouse Operation.....	34
2.6	Mouse Control .....	35
3	Local Basic Operation .....	38
3.1	Boot up and Shutdown.....	38
3.1.1	Boot up.....	38
3.1.2	Shutdown.....	38
3.2	Change/Reset Password .....	38
3.2.1	Change Password.....	38
3.2.2	Reset Password.....	39
3.3	Startup Wizard.....	40

3.4	Navigation Bar .....	44
3.4.1	Main Menu .....	45
3.4.2	Dual-screen operation .....	45
3.4.3	Output Screen .....	45
3.4.4	Tour .....	45
3.4.5	PTZ .....	45
3.4.6	Color .....	45
3.4.7	Search .....	45
3.4.8	Audio Broadcast .....	45
3.4.9	Alarm Status .....	46
3.4.10	Channel Info .....	46
3.4.11	Remote Device .....	46
3.4.12	Network .....	46
3.4.13	HDD Manager .....	46
3.4.14	USB Manager .....	46
3.4.15	System Status .....	47
3.4.16	Device Tree .....	47
3.5	Remote Device .....	48
3.5.1	Remote Device Connection .....	48
3.5.2	Short-Cut Menu .....	53
3.5.3	Image .....	53
3.5.4	Channel Name .....	55
3.5.5	Upgrade .....	56
3.6	Preview .....	57
3.6.1	Preview .....	57
3.6.2	Preview Control Interface .....	58
3.6.3	Right Click Menu .....	59
3.6.4	Preview Display Effect Setup .....	60
3.6.4.1	Display .....	60
3.6.4.2	Preview Tour Parameters .....	62
3.6.4.3	Custom Split .....	63
3.7	Fish Eye .....	65
3.7.1	Fish eye de-warp during preview interface .....	65
3.7.2	Fish eye de-warp during playback .....	67
3.8	Split Track .....	67
3.9	Smart Track .....	68
3.10	PTZ .....	69
3.10.1	PTZ Settings .....	69
3.10.2	PTZ Control .....	70
3.10.2.1	PTZ Function Setup .....	73
3.10.2.2	Call PTZ Function .....	75
3.11	Record and Snapshot .....	76
3.11.1	Encode .....	76
3.11.1.1	Encode .....	76
3.11.1.2	Overlay .....	77
3.11.2	Schedule .....	78

3.11.2.1	Schedule Record.....	78
3.11.2.2	Schedule Snapshot.....	81
3.11.3	Motion Detect Record/Snapshot.....	83
3.11.3.1	Motion detect record.....	83
3.11.3.2	Motion Detect Snapshot.....	85
3.11.4	Alarm Record/Snapshot.....	86
3.11.4.1	Alarm Record.....	86
3.11.4.2	Alarm Snapshot.....	87
3.11.5	Manual Record/Snapshot.....	87
3.11.5.1	Manual Record.....	87
3.11.5.2	Manual Snapshot.....	88
3.11.6	Holiday Record/Snapshot.....	88
3.11.6.1	Holiday Record.....	88
3.11.6.2	Holiday Snapshot.....	90
3.11.7	Other Record/Snapshot.....	90
3.12	Search and Playback.....	90
3.12.1	Real-time Playback.....	90
3.12.2	Search Interface.....	90
3.12.3	Accurate Playback by Time.....	95
3.12.4	Smart Motion Detect Search.....	95
3.12.5	Mark Playback.....	96
3.12.6	Picture Playback.....	97
3.12.7	Splice Playback.....	98
3.12.8	Smart Playback.....	98
3.12.8.1	Behavior Analysis.....	99
3.12.8.1.1	Tripwire.....	99
3.12.8.1.2	Intrusion.....	99
3.12.8.2	Face Detect Playback.....	101
3.12.8.3	Video Synopsis.....	102
3.13	Backup.....	104
3.13.1	File Backup.....	104
3.13.2	Import/Export.....	105
3.13.3	Backup Log.....	106
3.13.4	USB Device Auto Pop-up.....	107
3.14	Alarm.....	108
3.14.1	Video Detect.....	108
3.14.1.1	Motion Detect.....	108
3.14.1.2	Video Loss.....	111
3.14.1.3	Tampering.....	111
3.14.1.4	Scene Changing.....	112
3.14.1.5	Video Analytics.....	113
3.14.2	IVS Plan (Optional).....	115
3.14.3	Behavior Analytics (Optional).....	116
3.14.3.1	Tripwire (Optional).....	117
3.14.3.2	Intrusion (Cross warning zone) (Optional).....	121
3.14.3.3	Abandoned Object Detect (Optional).....	123

3.14.3.4	Missing Object Detection (Optional)	125
3.14.3.5	Loitering Detection (Optional)	127
3.14.3.6	Crowd Gathering Detection (Optional)	128
3.14.3.7	Fast moving (Optional)	130
3.14.3.1	Global Setup (Optional)	132
3.14.4	Face Detect (Optional)	135
3.14.5	People Counting (Optional)	135
3.14.6	Heat Map (Optional)	136
3.14.7	Audio Detect	137
3.14.8	Smart Track (Optional)	138
3.14.9	Alarm Output	142
3.14.10	Alarm Setup	143
3.14.11	Abnormality	148
3.15	Network	150
3.15.1	Network Settings	150
3.15.1.1	TCP/IP	150
3.15.1.2	Port	153
3.15.1.3	PPPoE	154
3.15.1.4	DDNS	155
3.15.1.5	UPnP	157
3.15.1.6	IP Filter	158
3.15.1.7	Email	160
3.15.1.8	FTP	161
3.15.1.9	SNMP	163
3.15.1.10	Multicast	164
3.15.1.11	Alarm Centre	166
3.15.1.12	Auto register	166
3.15.1.13	Cluster IP	167
3.15.2	Network Test	168
3.15.2.1	Network Test	168
3.15.2.2	Network Load	169
3.16	HDD Setup	170
3.16.1	Format	170
3.16.2	HDD Information	171
3.16.3	Advanced	173
3.16.4	ISCSI	175
3.16.5	RAID	175
3.16.5.1	RAID Config	175
3.16.5.2	RAID Info	176
3.16.5.3	Hotspare Disks	177
3.16.6	HDD Detect	177
3.16.6.1	Manual Detect	177
3.16.6.2	Detect Report	178
3.17	Basic Setups	179
3.17.1	Device Setup	179
3.17.2	Date and Time	180

3.17.3	Holiday .....	181
3.18	POS .....	182
3.19	Audio Broadcast .....	184
3.20	Device Maintenance and Manager .....	186
3.20.1	System Info.....	186
3.20.1.1	Version .....	186
3.20.1.2	BPS .....	186
3.20.1.3	Device Status .....	187
3.20.1.4	Online User .....	187
3.20.1.5	Remote Device Information .....	188
3.20.1.5.1	Alarm Status.....	188
3.20.1.5.2	Analytics .....	188
3.20.1.5.3	People Counting.....	189
3.20.1.5.4	Heat Map.....	190
3.20.1.6	Remote.....	191
3.20.1.6.1	Device Status.....	191
3.20.1.6.2	Firmware.....	192
3.20.2	Log.....	193
3.20.3	Account .....	194
3.20.3.1.1	Add User .....	195
3.20.3.1.2	Modify user.....	197
3.20.3.1.3	Change Password .....	198
3.20.3.1.4	Add/Modify Group .....	198
3.20.3.1.5	Security Question.....	200
3.20.4	Update.....	201
3.20.5	Default.....	202
3.20.6	Auto Maintain .....	203
3.20.7	Logout /Shutdown/Restart.....	204
4	Web Operation.....	205
4.1	General Introduction .....	205
4.1.1	Preparation.....	205
4.1.2	Log in.....	205
4.2	LAN Mode.....	207
4.3	Real-Time Monitor.....	209
4.4	PTZ.....	210
4.5	Image/Alarm-out.....	212
4.5.1	Image .....	212
4.5.2	Alarm Output.....	212
4.6	Zero-channel Encode .....	212
4.7	WAN Login .....	213
4.8	Setup.....	214
4.8.1	Camera .....	214
4.8.1.1	Remote Device .....	214
4.8.1.1.1	Remote Device.....	214
4.8.1.1.2	Upgrade.....	218
4.8.1.2	Image .....	219

4.8.1.3	Encode.....	221
4.8.1.3.1	Encode.....	221
4.8.1.3.2	Snapshot.....	222
4.8.1.3.3	Video Overlay .....	223
4.8.1.3.4	Path .....	223
4.8.1.4	Camera Name.....	224
4.8.2	Network.....	225
4.8.2.1	TCP/IP.....	225
4.8.2.2	Connection .....	227
4.8.2.3	PPPoE.....	228
4.8.2.4	DDNS .....	229
4.8.2.5	IP filter .....	230
4.8.2.6	Email .....	231
4.8.2.7	FTP .....	232
4.8.2.8	UPnP .....	233
4.8.2.9	SNMP .....	234
4.8.2.10	Multicast.....	235
4.8.2.11	Register.....	235
4.8.2.12	Alarm Centre .....	236
4.8.2.13	HTTPS .....	236
4.8.2.13.1	Create Server Certificate .....	237
4.8.2.13.2	Download root certificate.....	237
4.8.2.13.3	View and set HTTPS port .....	240
4.8.2.13.4	Login.....	241
4.8.3	Event .....	241
4.8.3.1	Video detect .....	241
4.8.3.1.1	Motion Detect .....	241
4.8.3.1.2	Video Loss .....	245
4.8.3.1.3	Tampering .....	246
4.8.3.1.4	Scene Change.....	247
4.8.3.1.5	Video analytics.....	247
4.8.3.2	IVS Plan .....	248
4.8.3.3	Behavior Analytics (Optional) .....	249
4.8.3.3.1	Behavior Analytics .....	249
4.8.3.3.2	Global Config.....	258
4.8.3.4	Face Detect (Optional) .....	259
4.8.3.5	People Counting .....	259
4.8.3.6	Heat Map .....	260
4.8.3.7	Audio Detect.....	261
4.8.3.8	Smart Track.....	262
4.8.3.9	Alarm .....	265
4.8.3.9.1	Local Alarm .....	265
4.8.3.9.2	Net Alarm.....	268
4.8.3.9.3	IPC external alarm .....	269
4.8.3.9.4	IPC Offline Alarm.....	270
4.8.3.10	Abnormality .....	270



4.8.3.11	Alarm Output.....	272
4.8.4	Storage.....	272
4.8.4.1	Schedule.....	272
4.8.4.1.1	Record.....	272
4.8.4.1.2	Snapshot.....	275
4.8.4.2	HDD Manager.....	275
4.8.4.3	Record Control.....	275
4.8.4.4	Advanced.....	276
4.8.4.4.1	HDD.....	276
4.8.4.4.2	Main Stream.....	277
4.8.4.4.3	Sub Stream.....	277
4.8.4.4.4	Snapshot.....	278
4.8.4.5	RAID Manager.....	278
4.8.4.5.1	RAID Config.....	278
4.8.4.5.2	RAID Info.....	278
4.8.4.5.3	Hotspare disks.....	279
4.8.4.6	iSCSI.....	279
4.8.5	Setting.....	281
4.8.5.1	General.....	281
4.8.5.1.1	General.....	281
4.8.5.1.2	Date and time.....	282
4.8.5.1.3	Holiday Setup.....	283
4.8.5.2	Display.....	284
4.8.5.2.1	Display.....	284
4.8.5.2.2	Tour.....	285
4.8.5.2.3	Custom Split.....	286
4.8.5.3	RS232.....	286
4.8.5.4	PTZ.....	287
4.8.5.5	POS.....	288
4.8.5.6	Account.....	290
4.8.5.6.1	User name.....	290
4.8.5.6.2	Group.....	292
4.8.5.7	Auto maintain.....	293
4.8.5.8	Import/Export.....	294
4.8.5.9	Default.....	294
4.8.5.10	Upgrade.....	295
4.8.6	Cluster Service.....	295
4.8.6.1	Cluster IP.....	295
4.8.6.2	Master Device.....	296
4.8.6.3	Slave Device.....	297
4.8.6.4	Record Transfer.....	298
4.8.6.5	Cluster control.....	299
4.8.6.5.1	Cluster control.....	299
4.8.6.5.2	Arbitration IP.....	300
4.8.6.6	DCS Log.....	300
4.9	Info.....	300

4.9.1	Version .....	300
4.9.2	Log .....	301
4.9.3	Online User.....	302
4.9.4	Video Analytics.....	302
4.9.5	People Counting .....	303
4.9.6	Heat Map .....	303
4.9.7	HDD.....	304
4.10	Playback.....	304
4.10.1	Search record.....	305
4.10.2	File List.....	306
4.10.3	Playback .....	306
4.10.4	Download.....	307
4.10.5	Load more.....	308
4.10.6	Lock file .....	309
4.10.7	Unlock file .....	309
4.11	Smart Playback .....	309
4.11.1	Behavior Analysis .....	310
4.11.1.1	Tripwire .....	310
4.11.1.2	Intrusion .....	311
4.11.1.3	Face Detect Playback.....	313
4.11.1.4	Video Synopsis .....	314
4.12	Alarm.....	314
4.13	Log out.....	315
4.14	Un-install Web Control.....	315

## **Welcome**

Thank you for purchasing our network video recorder!

This user's manual is designed to be a reference tool for your system.

Please open the accessory bag to check the items one by one in accordance with the list below.

Contact your local retailer ASAP if something is missing or damaged in the bag.

# Important Safeguards and Warnings

## 1 . Electrical safety

All installation and operation here should conform to your local electrical safety codes.

The product must be grounded to reduce the risk of electric shock.

We assume no liability or responsibility for all the fires or electric shock caused by improper handling or installation.

## 2 . Transportation security

Heavy stress, violent vibration or water splash are not allowed during transportation, storage and installation.

## 3 . Installation

Keep upwards. Handle with care.

Do not apply power to the NVR before completing installation.

Do not place objects on the NVR.

## 4 . Qualified engineers needed

All the examination and repair work should be done by the qualified service engineers.

We are not liable for any problems caused by unauthorized modifications or attempted repair.

## 5 . Environment

The NVR should be installed in a cool, dry place away from direct sunlight, inflammable, explosive substances and etc.

This series product shall be transported, storage and used in the specified environments.

Environment which needs to comply with the following conditions:

- The function of the ITE being investigated to IEC 60950-1 is considered not likely to require connection to an Ethernet network with outside plant routing, including campus environment.
- The installation instructions clearly state that the ITE is to be connected only to PoE networks without routing to the outside plant.

## 6. Accessories

Be sure to use all the accessories recommended by manufacturer.

Before installation, please open the package and check all the components are included.

Contact your local retailer ASAP if something is broken in your package.

## 7. Lithium battery

Improper battery use may result in fire, explosion, or personal injury!

When replace the battery, please make sure you are using the same model!

### **CAUTION**

**RISK OF EXPLOSION IF BATTERY IS REPLACED BY AN INCORRECT TYPE.**

**DISPOSE OF USED BATTERIES ACCORDING TO THE INSTRUCTIONS.**

**Before your operation please read the following instructions carefully.**

- **Installation environment**

- ✧ Keep away from extreme hot places and sources;
- ✧ Avoid direct sunlight;
- ✧ Keep away from extreme humid places;
- ✧ Avoid violent vibration;
- ✧ Do not put other devices on the top of the NVR;
- ✧ Be installed in well ventilated place; do not block the vent.

- **Accessories**

Check the following accessories after opening the box:

- **Please refer to the packing list in the box \***

# 1 Features and Specifications

## 1.1 Overview

This series NVR is a high performance network video recorder. This series product support local preview, multiple-window display, recorded file local storage, remote control and mouse shortcut menu operation, and remote management and control function.

This series product supports centre storage, front-end storage and client-end storage. The monitor zone in the front-end can be set in anywhere. Working with other front-end devices such as IPC, NVS, this series product can establish a strong surveillance network via the CMS. In the network system, there is only one network cable from the monitor centre to the monitor zone in the whole network. There is no audio/video cable from the monitor centre to the monitor zone. The whole project is featuring of simple connection, low-cost, low maintenance work.

This series NVR can be widely used in many areas such as public security, water conservancy, transportation and education.

## 1.2 Features

<b>Real-time Surveillance</b>	<ul style="list-style-type: none"><li>• VGA, HDMI port. Connect to monitor to realize real-time surveillance. Some series support TV/VGA/HDMI output at the same time.</li><li>• Short-cut menu when preview.</li><li>• Support popular PTZ decoder control protocols. Support preset, tour and pattern.</li></ul>
<b>Playback</b>	<ul style="list-style-type: none"><li>• Support each channel real-time record independently, and at the same time it can support search, forward play, network monitor, record search, download and etc.</li><li>• Support various playback modes: slow play, fast play, backward play and frame by frame play.</li><li>• Support time title overlay so that user may view event accurate occurred time</li><li>• Support specified zone enlargement.</li></ul>
<b>User Management</b>	<ul style="list-style-type: none"><li>• Each group has different management powers that can be edited freely. Every user belongs to an exclusive group.</li></ul>
<b>Storage</b>	<ul style="list-style-type: none"><li>• Via corresponding setup (such as alarm setup and schedule setup), user may backup related audio/video data in the network video recorder.</li><li>• Support Web record and record local video and storage the file in the client end.</li></ul>
<b>Alarm</b>	<ul style="list-style-type: none"><li>• Respond to external alarm simultaneously (within 200MS), based on user's pre-defined relay setup, system can process the alarm input correctly and prompt user by screen and voice (support pre-recorded audio).</li><li>• Support central alarm server setup, so that alarm information can remotely notify user automatically. Alarm input can be derived from various connected peripheral devices.</li><li>• Alert you via email/sms.</li></ul>

<b>Network Monitor</b>	<ul style="list-style-type: none"> <li>Through network, sending audio/video data compressed by IPC or NVS to client-ends, then the data will be decompressed and display.</li> <li>Support max 128 connections at the same time.</li> <li>Transmit audio/video data by HTTP, TCP, UDP, MULTICAST, RTP/RTCP and etc.</li> <li>Transmit some alarm data or alarm info by SNMP.</li> <li>Support WEB access in WAN/LAN.</li> </ul>
<b>Window Split</b>	<ul style="list-style-type: none"> <li>Adopt the video compression and digital process to show several windows in one monitor. Support 1/4/8/9/16/ 25/36-window display when preview and 1/4/9/16-window display when playback.</li> </ul>
<b>Record</b>	<ul style="list-style-type: none"> <li>Support normal/motion detect/alarm record function. Save the recorded files in the HDD, USB device, client-end PC, or network storage server. User may search or playback the saved files at the local-end or via the Web/USB device.</li> </ul>
<b>Backup</b>	<ul style="list-style-type: none"> <li>Support network backup, USB2.0 record backup function, the recorded files can be saved in network storage server, peripheral USB2.0 device, burner and etc.</li> </ul>
<b>Network Management</b>	<ul style="list-style-type: none"> <li>Supervise NVR configuration and control power via Ethernet.</li> <li>Support management via WEB.</li> </ul>
<b>Peripheral Equipment Management</b>	<ul style="list-style-type: none"> <li>Support peripheral equipment management such as protocol setup and port connection.</li> <li>Support transparent data transmission such as RS232 (RS-422), RS485 (RS-485).</li> </ul>
<b>Auxiliary</b>	<ul style="list-style-type: none"> <li>Support switch between NTSC and PAL.</li> <li>Support real-time system resources information and running statistics display.</li> <li>Support log file.</li> <li>Local GUI output. Shortcut menu operation via mouse.</li> <li>IR control function (For some series product only). Shortcut menu operation via remote control.</li> <li>Support IPC or NVS remote video preview and control.</li> </ul>

## 1.3 Specifications

### 1.3.1 DNA4000 3U NVR Series

Specifications		64-ch	128-ch
	<b>Main Processor</b>	Industrial X86 multiple-core processor	
	<b>Operation System</b>	Embedded LINUX system	
	<b>Power</b>	Support hot swap	
	<b>Fan</b>	Redundant dual ball bearing fan MTBF>100 thousand hours Support online replacement.	
	<b>Memory</b>	4GB (Max 8G) Server-level (With ECC verification)	2GB (Max 8G) Server-level (With ECC verification)
	<b>Case</b>	1.2mm extra-thickness hot-dip galvanized steel. High accuracy aluminum alloy slider. Self-developed patent removable HDD bracket.	
	<b>User Interface</b>	WEB GUI	

	<b>Network Protocol</b>	RTP/RTCP, RTSP, UDP, HTTP, NTP, SNMP	
<b>Audio/Video</b>	<b>Audio/Video Connection</b>	384M connection	192M connection
	<b>Audio/Video Transmission</b>	384M transmission	192M transmission
	<b>Audio/Video Storage</b>	Based on 64-bit high-performance file system.	
	<b>Video Resolution</b>	1080P, 720P, D1, HD1, CIF, QCIF	
	<b>Audio/Video Search</b>	Based on data library and menu tree. Support various search engines.	
	<b>Audio/Video Setup</b>	Support one camera or a batch of camera setup at the same time.	
	<b>Record Policy</b>	Schedule record, manual record, alarm record	
	<b>Alarm Record Type</b>	Video loss, motion detect, camera masking, external alarm.	
<b>Data Management</b>	<b>HDD Amount</b>	16 SATA HDDs (Max 4T space per HDD)	
	<b>HDD Mode</b>	One HDD, RAID0, RAID1, RAID5.	
	<b>HDD Installation</b>	Additional HDD bracket, support HDD hot swap.	
	<b>Disk Array Enclosure/Backup</b>	Mini SAS port 3Gbps(Optional)	
	<b>HDD Hotspare</b>	Support global hotspare.	
<b>Network Interface</b>	<b>Network Amount</b>	4 100/1000Mbps Ethernet ports	
	<b>Network Port Feature</b>	4-Ethernet port load balance or 4 independent 1000Mbps Ethernet port.	
<b>Others</b>	<b>Power</b>	100V~240V, 47~63Hz	
	<b>Total Power Consumption</b>	60W~200W (Including HDD)	
	<b>Working Temperature</b>	0℃~50℃	
	<b>Working Humidity</b>	5%~90% (Non-condense)	
	<b>Storage Temperature</b>	-20℃~70℃	
	<b>Storage Humidity</b>	5%~90% (Non-condense)	
	<b>Working Altitude</b>	-60m~3000m	
	<b>Dimensions (L×W×H)</b>	531.9(with the LCD length)mm×485mm(With ear)×133.2mm(H) 518(without the LCD length)×482mm(without ear)×133.2mm(H)	
	<b>Net Weight</b>	20Kg (Excluding HDD)	
	<b>Installation Mode</b>	Standard 19-inch rack installation	



### 1.3.2 DNA3500, DNA3700, DNA3750 4K 2U NVR Series

Model		32-ch	64-ch	128-ch	64-ch with redundant power supplying	128-ch with redundant power supplying
<b>System</b>	<b>Main Processor</b>	Industrial X86 multiple-core processor				
	<b>Operation System</b>	Embedded LINUX system				
	<b>System Resources</b>	Max 32-channel×1080P connection	Max 64-channel×1080P connection	Max 128-channel×1080P connection	Max 64-channel×1080P connection	Max 128-channel×1080P connection
	<b>User Interface</b>	WEB, local GUI				
<b>Audio Parameters</b>	<b>Audio Input</b>	1-ch MIC bidirectional talk audio input				
	<b>Audio Output</b>	1-ch MIC bidirectional talk audio output				
	<b>Audio Compression Standard</b>	G.711a				
<b>Video Parameters</b>	<b>Video Input</b>	32-ch network compression video input	64-ch network compression video input	128-ch network compression video input	64-ch network compression video input	128-ch network compression video input
	<b>Video Output</b>	1-ch VGA output, 2-ch HDMI output				
	<b>Video Compression Standard</b>	H.264				
	<b>Window Split Mode</b>	The 1st screen: 1/4/8/9/16/25-screen. The 2nd screen: 1/4/8/9/16-screen.	The 1st screen: 1/4/8/9/16/25/36-screen. The 2nd screen: 1/4/8/9/16-screen.			
<b>Alarm Parameters</b>	<b>Alarm Input</b>	16-channel				
	<b>Alarm Output</b>	8-channel relay output				

Model		32-ch	64-ch	128-ch	64-ch with redundant power supplying	128-ch with redundant power supplying
Decode Parameters	Decode Type	H.264;MPEG4				
	Decode Capability	32-channel D1;16-channel 720P, 8-channel×1080P				
Network Function	Record Mode	Manual recording, motion detection recording, schedule recording and alarm recording. Priority: Manual recording>card number recording-> alarm recording>motion detection recording>schedule recording.				
	Multi-Channel Playback	Max support 128M playback at the same time.				
	Motion Detect	Each screen supports 396/330((PAL 22×18, NTSC 22×15) detection zones. Various sensitivity levels.				
	Privacy Mask	Each channel supports 4 privacy mask zones.				
	Record Mode	Overwrite				
	Backup Mode	Flash disk, eSATA, DVD burner.				
	Network Protocol	SNMP/FTP/ISCSI/UPNP				
	SATA Port	8				
	eSATA Port	1				
	RS232 Port	1 RS232 port. To debug and transmit COM data.				
	RS485 Port	1 RS485 port. To control peripheral PTZ and etc. Support various protocols.				
	USB Port	3 USB 2.0 ports and 1 USB3.0 port.				
	HDMI Port	2 HDMI ports				
	Network Port	2 RJ45 10/100/1000Mbps self-adaptive Ethernet ports				
	Power On-off Button	One at the front panel.			N/A	
	Power Button	One at the front panel.				
IR Remote Control Receiver	One at the front panel.					

Model		32-ch	64-ch	128-ch	64-ch with redundant power supplying	128-ch with redundant power supplying
	<b>Indicator Light</b>	<ul style="list-style-type: none"> <li>● 1 HDD alarm indicator light</li> <li>● 1 system running status indicator light</li> <li>● 1 network alarm indicator light</li> <li>● 1 power light</li> </ul>	18 indicator lights. <ul style="list-style-type: none"> <li>● 16 record status indicator light</li> <li>● 1 system running status indicator light</li> <li>● 1 remote control button indicator light</li> </ul>			
<b>General Parameters</b>	<b>Power</b>	AC110~240V, 50~60Hz			AC100~240V, 50~60Hz	
	<b>Power Consumption</b>	<40W (No HDD)				
	<b>Working Temperature</b>	-10°C~+55°C				
	<b>Working Humidity</b>	10%~90%				
	<b>Dimensions(L×W×H)</b>	450.8mm × 482mm(with ear) × 91mm ( with foot pad) 450.8mm × 440mm(without ear) × 90.4mm (without foot pad)	454.9mm × 486mm(with ear) × 91mm ( with foot pad) 454.9mm × 444mm(without ear) × 90.4mm ( without foot pad)	471.8mm × 486mm(with ear) × 91mm (with foot pad) 471.8mm × 444mm(without ear) × 90.4mm (without foot pad)		
	<b>Weight</b>	9kg (No HDD)				
	<b>Installation Mode</b>	Rack/desktop				

### 1.3.3 DNA 4K S2 2U NVR Series

Model		32-ch	64-ch	128-ch	64-ch with redundant power supplying	128-ch with redundant power supplying
System	Main Processor	Industrial X86 multiple-core processor				
	Operation System	Embedded LINUX system				
	System Resources	Max 32-channel×1080P connection	Max 64-channel×1080P connection	Max 128-channel×1080P connection	Max 64-channel×1080P connection	Max 128-channel×1080P connection
	User Interface	WEB, local GUI				
Audio Parameters	Audio Input	1-ch MIC bidirectional talk audio input				
	Audio Output	1-ch MIC bidirectional talk audio output				
	Audio Compression Standard	G.711a				
Video Parameters	Video Input	32-ch network compression video input	64-ch network compression video input	128-ch network compression video input	64-ch network compression video input	128-ch network compression video input
	Video Output	1-ch VGA output, 2-ch HDMI output				
	Video Compression Standard	H.264/ H.265				
	Window Split Mode	The 1st screen: 1/4/8/9/16/25/36-screen. The 2nd screen: 1/4/8/9/16-screen.				
Alarm Parameters	Alarm Input	16-channel				
	Alarm Output	8-channel relay output				
Decode Parameters	Decode Type	H.264;MPEG4;H.265				
	Decode Capability	16-channel×1080P				

Model		32-ch	64-ch	128-ch	64-ch with redundant power supplying	128-ch with redundant power supplying
Network Function	Record Mode	Manual recording, motion detection recording, schedule recording and alarm recording. Priority: Manual recording>card number recording-> alarm recording>motion detection recording>schedule recording.				
	Multi-Channel Playback	Max support 128M playback at the same time.				
	Motion Detect	Each screen supports 396/330((PAL 22×18, NTSC 22×15) detection zones. Various sensitivity levels.				
	Privacy Mask	Each channel supports 4 privacy mask zones.				
	Record Mode	Overwrite				
	Backup Mode	Flash disk, eSATA, DVD burner.				
	Network Protocol	SNMP/FTP/ISCSI/UPNP				
	SATA Port	8				
	eSATA Port	1				
	RS232 Port	1 RS232 port. To debug and transmit COM data.				
	RS485 Port	1 RS485 port. To control peripheral PTZ and etc. Support various protocols.				
	USB Port	2 USB 2.0 ports and 2 USB3.0 ports.				
	HDMI Port	2 HDMI ports				
	Network Port	2 RJ45 10/100/1000Mbps self-adaptive Ethernet ports				
	Power On-off Button	One at the front panel.				N/A
	Power Button	One at the front panel.				
	IR Remote Control Receiver	N/A				
Indicator Light	<ul style="list-style-type: none"> <li>● 1 HDD alarm indicator light</li> <li>● 1 system running status</li> </ul>	<ul style="list-style-type: none"> <li>● 1 HDD alarm indicator light</li> <li>● 1 alarm indicator light</li> <li>● 1 network alarm indicator light</li> <li>● 1 power light</li> </ul>				

Model		32-ch	64-ch	128-ch	64-ch with redundant power supplying	128-ch with redundant power supplying
		indicator light ● 1 network alarm indicator light ● 1 power light				
General Parameters	Power	AC110~240V, 50~60Hz			AC100~240V, 50~60Hz	
	Power Consumption	<20W (No HDD) , <90w (4T*8)				
	Working Temperature	-10°C~+55°C				
	Working Humidity	10%~90%				
	Dimensions(L×W×H)	450.8mm × 482mm(with ear) × 91mm ( with foot pad) 450.8mm × 440mm(without ear) × 90.4mm (without foot pad)	454.9mm × 486mm(with ear) × 91mm ( with foot pad) 454.9mm × 444mm(without ear) × 90.4mm ( without foot pad)	471.8mm × 486mm(with ear) × 91mm (with foot pad) 471.8mm × 444mm(without ear) × 90.4mm (without foot pad)		
	Dimensions(L×W×H) (With Package)	571*571*225mm			632*585*242mm	
	Weight	8kg (No HDD)			8.7kg (No HDD)	
	Installation Mode	Rack/desktop				

### 1.3.4 DNA 4K 3U NVR Series

Specifications		DNA 4K 3U NVR
System	Main Processor	Industrial embedded micro processor
	Operation System	Embedded LINUX system
	System Resources	Max 128-channel×1080P connection, Total bandwidth (main stream 256M, sub stream 128M.)
	User Interface	WEB, local GUI
Audio Parameters	Audio Input	1-ch MIC bidirectional talk audio input
	Audio Output	1-ch MIC bidirectional talk audio output
	Audio Compression Standard	G.711a
Video Parameters	Video Input	128-ch network compression video input
	Video Resolution	8MP/5MP/3MP/1080P/UXGA/960P/720P/D1/CIF
	Video Output	HDMI (support 3840*2160)
	Video Compression Standard	H.264
	Window Split Mode	The 1st screen: 1/4/8/9/16/25/36-screen. The 2nd screen: 1/4/8/9/16-screen.
Alarm Parameters	Alarm Input	16-channel
	Alarm Output	8-channel relay output
Decode Parameters	Decode Type	H.264;MPEG4
	Decode Capability	48-channel×D1;8-channel×1080P;2-channel 800w
Functions	Record Mode	Manual recording, motion detection recording, schedule recording and alarm recording. Priority: Manual recording>card number recording-> alarm recording>motion detection recording>schedule recording.
	Multi-Channel Playback	Max support 128M playback at the same time.
	Motion Detect	Each screen supports 396/330((PAL 22×18, NTSC 22×15) detection zones. Various sensitivity levels.
	Privacy Mask	Each channel supports 4 privacy mask zones.
	Record Mode	Overwrite
	Backup Mode	Flash disk, eSATA, DVD burner.
Network Function	Network Protocol	SNMP,FTP,ISCSI,UPNP
	SATA Port	16 SATA Ports
	eSATA Port	1 eSATA port
	RS232 Port	1 RS232 port. To debug and transmit COM data.
	RS485 Port	1 RS232 port. To control peripheral PTZ and etc. Support various protocols.
	USB Port	3 USB 2.0 ports and 1 USB3.0 port.

	<b>HDMI Port</b>	2 HDMI ports
	<b>Network Port</b>	4 RJ45 10/100/1000Mbps self-adaptive Ethernet ports+2 1000Mbps self-adaptive fiber ports
	<b>SAS Port</b>	1
	<b>Power On-off Button</b>	N/A
	<b>Power Button</b>	One at the front panel.
	<b>IR Remote Control Receiver</b>	One at the front panel.
	<b>Indicator Light</b>	35 indicator lights. <ul style="list-style-type: none"> <li>● 1 system HDD indicator light</li> <li>● 1 alarm indicator light</li> <li>● 1 network info indicator light</li> <li>● 16 HDD power indicator lights</li> <li>● 16 HDD read/write indicator lights</li> </ul>
<b>General Parameters</b>	<b>Power</b>	AC100~240V,50~60Hz
	<b>Power Consumption</b>	<170W (With 3T HDD)
	<b>Working Temperature</b>	-10℃~55℃
	<b>Working Humidity</b>	10%~90% (No condensation)
	<b>Dimensions (L × W × H)</b>	531.9(with the LCD length)mm × 485mm(with ear) × 133.2mm(H) 518(without the LCD length) × 482mm(without ear) × 133.2mm(H)
	<b>Weight</b>	17.45Kg (No HDD)
	<b>Installation Mode</b>	Rack/desktop

### 1.3.5 DNA 4K S2 3U NVR Series

Specifications		DNA 4K S2 3U NVR Series
<b>System</b>	<b>Main Processor</b>	Industrial embedded micro processor
	<b>Operation System</b>	Embedded LINUX system
	<b>System Resources</b>	Max 64/128-channel×1080P connection, Total bandwidth (main stream 256M, sub stream 128M.)
	<b>User Interface</b>	WEB, local GUI
<b>Audio Parameters</b>	<b>Audio Input</b>	1-ch MIC bidirectional talk audio input
	<b>Audio Output</b>	1-ch MIC bidirectional talk audio output
	<b>Audio Compression Standard</b>	G.711a
<b>Video Parameters</b>	<b>Video Input</b>	64/128-ch network compression video input
	<b>Video Output</b>	HDMI (support 3840*2160)
	<b>Video Compression Standard</b>	H.264



	<b>Window Split Mode</b>	The 1st screen: 1/4/8/9/16/25/36-screen. The 2nd screen: 1/4/8/9/16-screen.
<b>Alarm Parameters</b>	<b>Alarm Input</b>	16-channel
	<b>Alarm Output</b>	8-channel relay output
<b>Decode Parameters</b>	<b>Decode Type</b>	H.264;MPEG4
	<b>Decode Capability</b>	48-channel×D1;8-channel×1080P;2-channel 800w
<b>Functions</b>	<b>Record Mode</b>	Manual recording, motion detection recording, schedule recording and alarm recording. Priority: Manual recording>card number recording-> alarm recording>motion detection recording>schedule recording.
	<b>Multi-Channel Playback</b>	Max support 128M playback at the same time.
	<b>Motion Detect</b>	Each screen supports 396/330((PAL 22×18, NTSC 22×15) detection zones. Various sensitivity levels.
	<b>Privacy Mask</b>	Each channel supports 4 privacy mask zones.
	<b>Record Mode</b>	Overwrite
	<b>Backup Mode</b>	Flash disk, eSATA, DVD burner.
<b>Network Function</b>	<b>Network Protocol</b>	SNMP,FTP,ISCSI,UPNP
	<b>SATA Port</b>	16 SATA Ports
	<b>eSATA Port</b>	1 eSATA port
	<b>RS232 Port</b>	1 RS232 port. To debug and transmit COM data.
	<b>RS485 Port</b>	1 RS232 port. To control peripheral PTZ and etc. Support various protocols.
	<b>USB Port</b>	3 USB 2.0 ports and 1 USB3.0 port.
	<b>HDMI Port</b>	2 HDMI ports
	<b>Network Port</b>	4 RJ45 10/100/1000Mbps self-adaptive Ethernet ports 2 1000Mbps self-adaptive fiber ports
	<b>SAS Port</b>	1
	<b>Power On-off Button</b>	N/A
	<b>Power Button</b>	One at the front panel.
	<b>IR Remote Control Receiver</b>	One at the front panel.
	<b>Indicator Light</b>	35 indicator lights. <ul style="list-style-type: none"> <li>● 1 system HDD indicator light</li> <li>● 1 alarm indicator light</li> <li>● 1 network info indicator light</li> <li>● 16 HDD power indicator lights</li> <li>● 16 HDD read/write indicator lights</li> </ul>
<b>General Parameters</b>	<b>Power</b>	AC100~240V,50~60Hz
	<b>Power Consumption</b>	<170W (With 3T HDD)
	<b>Working Temperature</b>	-10℃~55℃

	<b>Working Humidity</b>	10%~90% (No condensation)
	<b>Dimensions (L × W × H)</b>	531.9(with the LCD length)mm × 485mm(with ear) × 133.2mm(H) 518(without the LCD length) × 482mm(without ear) × 133.2mm(H)
	<b>Weight</b>	17.45Kg (No HDD)
	<b>Installation Mode</b>	Rack/desktop

### 1.3.6 DNA5000 4U NVR Series

Specifications		DNA 4U NVR
<b>System</b>	<b>Main Processor</b>	Industrial X86 multiple-core processor
	<b>Operation System</b>	Embedded LINUX system
	<b>Power</b>	Support hot swap
	<b>Fan</b>	Redundant dual ball bearing fan MTBF>100 thousand hours Support online replacement.
	<b>Memory</b>	8GB Server-level
	<b>Case</b>	1.2mm extra-thickness hot-dip galvanized steel. High accuracy aluminum alloy slider. Self-developed patent removable HDD bracket.
	<b>User Interface</b>	WEB, local GUI
	<b>Network Protocol</b>	RTP/RTCP, RTSP, UDP, HTTP, NTP, SNMP
<b>Compression Standard</b>	<b>Image Compression Standard</b>	H.264, MotionJpeg,Mpeg4
	<b>Audio Compression Standard</b>	G711A, MpegLayerII
<b>Video Monitor</b>	<b>Image Display</b>	1/4/8/9/16/25/36/64-window
	<b>Video Output</b>	1-channel VGA output 2-channel HDMI output LCD output at the front panel (For special series only.) Support VGA/HDMI/LCD (For special series only) video output at the same time.
	<b>Monitor Tour</b>	Support monitor tour functions such as motion detection, and schedule auto control.
	<b>Resolution</b>	Real-time monitor VGA: 1280*1024, 1920*1080, 1024*768; HDMI : 1280*1024、1920*1080
	<b>Image Information</b>	Channel information, time information.
	<b>Color Configuration</b>	Hue, brightness, contrast, saturation and gain setup for each channel.
<b>Audio</b>	<b>Audio Input</b>	1-channel audio input
	<b>Audio Output</b>	1-channel audio output

	<b>Bidirectional Talk</b>	1-channel bidirectional talk input
<b>HDD</b>	<b>HDD Amount</b>	24 HDDs
	<b>HDD Installation</b>	Independent HDD bracket, support HDD hot swap.
	<b>Disk Array Enclosure/Backup Port</b>	eSATA port
	<b>HDD Backup</b>	Support global hotspare HDD
	<b>HDD Mode</b>	One HDD/RAID0/RAID1/RAID5
	<b>HDD Manager</b>	Non-working HDD adopts hibernation function. It is suitable to guarantee sound ventilation, lower power consumption and enhance HDD life span.
<b>Record and Playback</b>	<b>Record Mode</b>	Manual recording, motion detection recording, schedule recording and alarm recording. Priority: Manual recording>card number recording-> alarm recording>motion detection recording>schedule recording.
	<b>Record Repeat Mode</b>	When hard disk is full, system can overwrite previous video file.
	<b>Record Search</b>	Various search engines such as time, type and channel.
	<b>Playback Mode</b>	Various fast play, slow play speeds, manual frame by frame playback and reverse play mode.
	<b>Various File Switch Ways</b>	Can switch to previous or next file or any file in current play list. Can switch to file on other channel of the same time. (If there is a file) Support file continuous play, when a file is end system auto plays the next file in the current channel
	<b>Multi-Channel Playback</b>	Support 64-channel D1 playback at the same time.
<b>Backup function</b>	<b>Backup Mode</b>	HDD backup. Redundancy HDD backup.
		Support peripheral USB backup device. (Flash disk, portable disk and etc.)
		Support peripheral eSATA device.
		Support network download and save.
<b>Network Function</b>	<b>Network control</b>	View monitor channel remotely.
		NVR configuration through client-end and web browser
		Upgrade via client or browser to realize remote maintenance.
		View alarm information such as motion detection and video loss via client.
		Support network PTZ lens control
		File remote download and backup and playback
		Multiple devices share information via corresponding software such as professional surveillance software (PSS)
		Network alarm input and output
	Bidirectional audio.	
<b>Video Loss</b>	Alarm can activate record, external alarm, screen message prompt, or audio.	

	<b>External Alarm</b>	Support record activation function or activate external alarm or screen message in specified period.
	<b>Manual Alarm Control</b>	Enable or disable alarm input channel Simulate alarm signal to specific alarm output channel.
	<b>Alarm Input</b>	4-channel alarm input (NO/NC)
	<b>Alarm Output</b>	4-channel relay output
	<b>Alarm Relay</b>	30VDC 2A, 125VAC 1A (activation output)
<b>Port</b>	<b>USB port</b>	2 USB 2.0 ports, 2 USB 3.0 ports
	<b>Network Amount</b>	4 100/1000Mbps Ethernet ports
	<b>Network Features</b>	4 Ethernet port load balance or 4 independent 1000Mbps Ethernet ports.
	<b>RS485 RS232</b>	Serial port protocol communication
<b>User Management</b>	<b>User Management</b>	Multi-level user management; various management modes Integrated management for local user, serial port user and network user. Configurable user power.
		Support user /group and its corresponding rights modification. No limit to the user or group amount.
	<b>Password Authentication</b>	Password modification Administrator can modify other user's password.
		Account lock strategy Five times login failure in thirty minutes may result in account lock.
<b>Upgrade</b>		Client-end/update tool. USB device
<b>Login, Logout and Shutdown</b>		Password login protection to guarantee safety User-friendly interface when login. Provide the following options: Logout /shutdown/ restart. Right authentication when shut down to make sure only those proper people can turn off NVR.
<b>General Parameters</b>	<b>Power</b>	100V~240V, 47~63Hz
	<b>Power Consumption</b>	200~400W (With HDD)
	<b>Working Temperature</b>	0°C~40°C
	<b>Working Humidity</b>	10%~80% (No condensation)
	<b>Storage Environment Temperature</b>	-20°C~70°C
	<b>Storage environment Humidity</b>	5%~90% (No condensation)
	<b>Working Altitude</b>	-60m~5000m

	<b>Dimensions (L × W × H)</b>	545mm (with the LCD length) × 482.6mm (With ear) × 175mm (4U case) 514mm (without the LCD length) × 482.6mm (With ear) × 175mm (4U case) 493.5mm (without the LCD length) × 480mm (Without ear) × 175mm 4U case)
	<b>Weight</b>	27Kg (No package materials, no HDD)
	<b>Installation Mode</b>	Standard 19-inch rack installation Rack/desktop
	<b>HDD Amount</b>	24 SATA HDD (Max 4T/HDD)

## 2 Front Panel and Rear Panel

### 2.1 Front Panel

#### 2.1.1 DNA 3U NVR / DNA 4K 3U NVR/ DNA 4K S2 3U NVR Series

For the product of LCD, the front panel of DNA 3U NVR/DNA 4K 3U/DNA 4K S2 3U NVR is shown as below. See Figure 2-1.

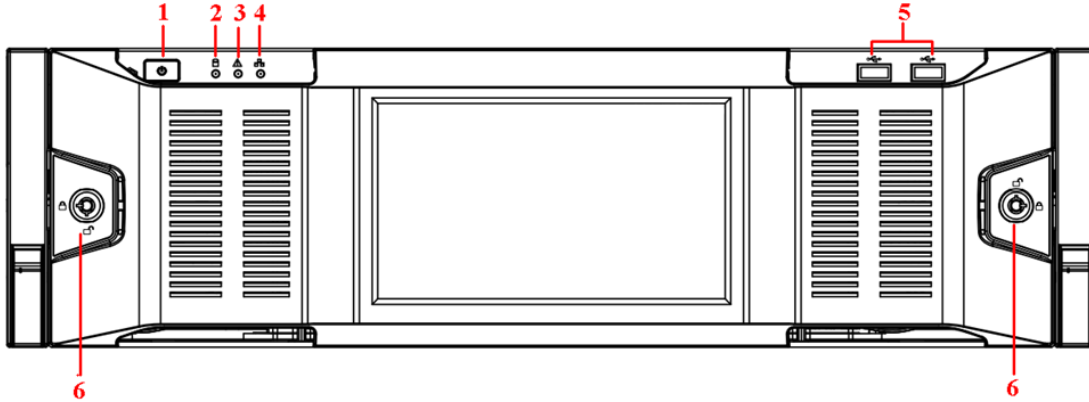

Figure 2-1

Please refer to the following sheet for front panel button information.

SN	Name	Function
1	Power button	Press it once to turn on the device. Press it for a long time to turn off the device. ( <b>Usually we do not recommend</b> ). Press power button for a long time or pull out the power cable may result in device auto restart.
2	System HDD Indicator light	The blue light becomes on after system booted up properly. In the system HDD, there are device important configuration file, factory default configuration file, and device initial boot up data.
3	Alarm indicator light	The alarm indicator light becomes on once an alarm occurred. It becomes on via the software detection. The alarm includes local alarm, no disk and etc. The indicator light becomes on when there is a local alarm.
4	Network indicator light	The blue network indicator light is on after you connected the device to the network.
5	USB port	/
6	Front panel lock	/

For general DNA 3U NVR/DNA 4K 3U/DNA 4K S2 3U NVR series, the front panel is shown as in Figure 2-2.

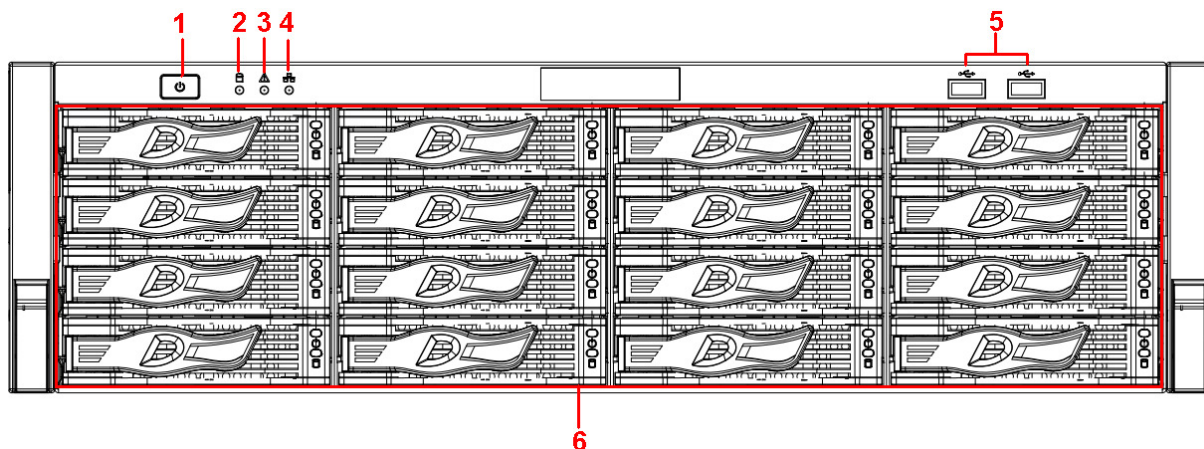

Figure 2-2

Please refer to the following sheet for detailed information.

SN	Name	Function
1	Power button	Press it once to turn on the device. Press it for a long time to turn off the device ( <b>Usually we do not recommend</b> ). Press power button for a long time or pull out the power cable may result in device auto restart.
2	System HDD Indicator light	The blue light becomes on after system booted up properly. In the system HDD, there are device important configuration file, factory default configuration file, device initial boot up data.
3	Alarm indicator light	The alarm indicator light becomes on once an alarm occurred. It becomes on via the software detection. The indicator light becomes on when there is a local alarm.
4	Network indicator light	The blue network indicator light is on after you connected the device to the network.
5	USB port	/
6	16 HDD slot	/

After you remove the front panel, user may see there are 16 HDDs. From the left to the right and from the top to the bottom, it ranges from 1~4, 5~8, 6~12, 13~16. See Figure 2-3.

User may see there are two indicator lights on the HDD bracket.

- The power indicator light is at the top. The light is yellow after you connected the device to the power.
- The read-write indicator light is at the bottom. The blue light flashes when system is reading or writing the data.

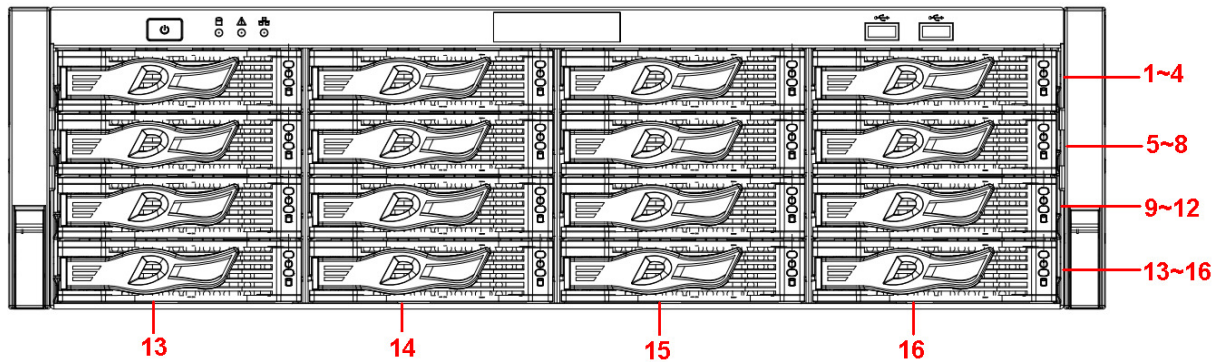

Figure 2-3

### 2.1.2 DNA 4K 2U NVR/ DNA 4K S2 2U NVR Series

The DNA 4K 2U 64/128-channel NVR front panel is shown as in Figure 2-4.

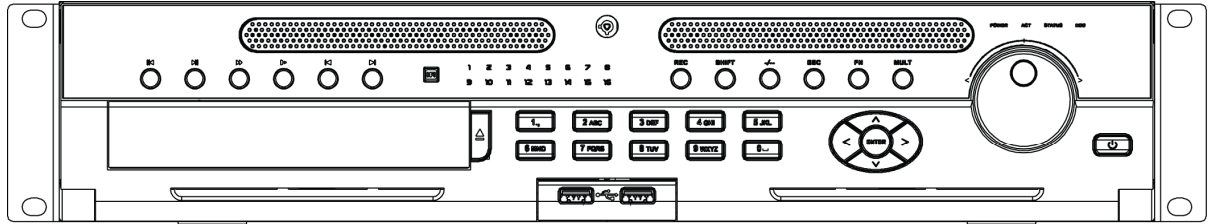



Figure 2-4

Please refer to the following sheet for detailed information.

Name	Icon	Function
Power button		Power button, press this button for three seconds to boot up or shut down NVR.
Number button	0-9 and etc	Input Arabic number Switch channel
Record	REC	Manually stop/start recording, working with direction keys or numeral keys to select the recording channel.
Input number more than 10	-/--	If you want to input a number more than 10, please click this button and then input.
ESC	ESC	Go to previous menu, or cancel current operation.
		When playback, click it to restore real-time monitor mode.
Assistant	Fn	One-window monitor mode, click this button to display assistant function: PTZ control and image color.
		Backspace function: in numeral control or text control, press it for 1.5seconds to delete the previous character before the cursor.



		In motion detection setup, working with Fn and direction keys to realize setup.
		In text mode, click it to switch between numeral, English character(small/capitalized) and etc.
		In HDD management interface, user may click it to switch HDD record information and other information (Menu prompt)
		Realize other special functions.
Window switch	<b>Mult</b>	Click it to switch one-window/multiple-window.
Shift	<b>↑</b>	In textbox, click this button to switch between numeral, English(Small/Capitalized),donation and etc.
		Enable or disable tour.
Up/ Down	<b>▲ ▼</b>	Activate current control, modify setup, and then move up and down.
		Increase/decrease numeral.
		Assistant function such as PTZ menu.
Left/ Right	<b>◀ ▶</b>	Shift current activated control, and then move left and right.
		When playback, click these buttons to control playback bar.
Slow play	<b>▶</b>	Multiple slow play speeds or normal playback.
Fast play	<b>▶▶</b>	Various fast speeds and normal playback.
Play previous	<b>◀</b>	In playback mode, playback the previous video.
Reverse/Pause	<b>   ◀</b>	In normal playback or pause mode, click this button to reverse playback In reverse playback, click this button to pause playback.
Play Next	<b>▶</b>	In playback mode, playback the next video
Play/Pause	<b>▶   </b>	In normal playback click this button to pause playback. In pause mode, click this button to resume playback. In backward playback or pause mode, click this button to resume normal playback. In real-time monitor mode, click this button to go to the search menu.
Enter	<b>ENTER</b>	Confirm current operation
		Go to default button
		Go to menu

Shuttle(outer ring)		In real-time monitor mode it works as left/right direction key. Playback mode, counter clockwise to forward and clock wise to backward.
Jog(inner dial)		Up/down direction key. Playback mode, turn the inner dial to realized frame by frame playback. (Only applies to some special versions.)
USB port		To connect USB storage device, USB mouse and etc.
Channel indicator light	<b>1-16</b>	It becomes on when system is recording.
IR Receiver	<b>IR</b>	It is to receive the signal from the remote control.
Power indicator light	<b>POWER</b>	Power indicator light.
Remote control indicator light	<b>ACT</b>	Remote control indicator light.
Status indicator light	<b>STATUS</b>	If there is Fn indicator light, current status indicator light is null.
HDD abnormal indicator light	<b>HDD</b>	The indicator light is on when there is no HDD, HDD error occurred or HDD capacity is below specified threshold value.

The DNA 4K 2U 32-channel/ DNA 4K S2 2U 32-channel NVR front panel is shown as in Figure 2-5.

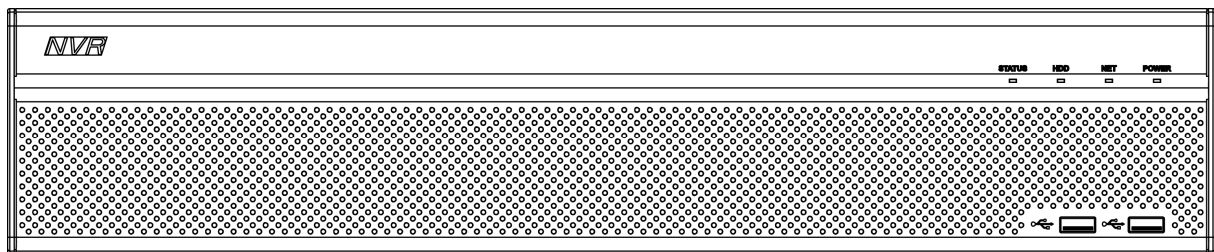



Figure 2-5

Please refer to the following sheet for front panel button information.

Icon	Name	Function
STATUS	Status indicator light	The blue light is on when the device is working properly.
HDD	HDD status indicator light	The blue light is on when the HDD is malfunction.

Icon	Name	Function
NET	Network status indicator light	The blue light is on when the network connection is abnormal.
POWER	Power status indicator light	The blue light is on when the power connection is OK.
	USB2.0 port	Connect to peripheral USB 2.0 storage device, mouse, burner and etc.

The DNA 4K S2 2U 64/128-channel NVR front panel is shown as in Figure 2-6.

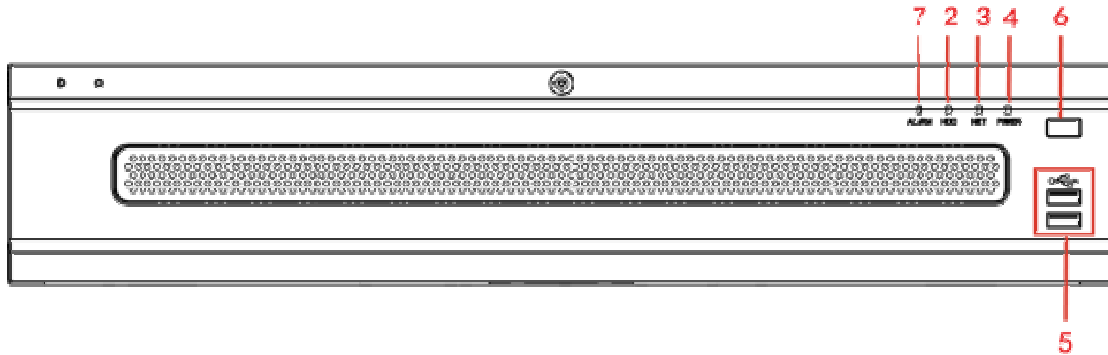



Figure 2-6

Please refer to the following sheet for front panel button information.

SN	Icon	Function	SN	Icon	Function
1	Status	Status indicator light	2	HDD	HDD indicator light
3	NET	Network indicator light	4	Power	Power indicator light
5		USB port	6		Power on-off button
7	ALARM	Alarm indicator light	-	-	

### 2.1.3 DNA 4U NVR Series

For the product of the LCD screen, the front panel is shown as in Figure 2-7.

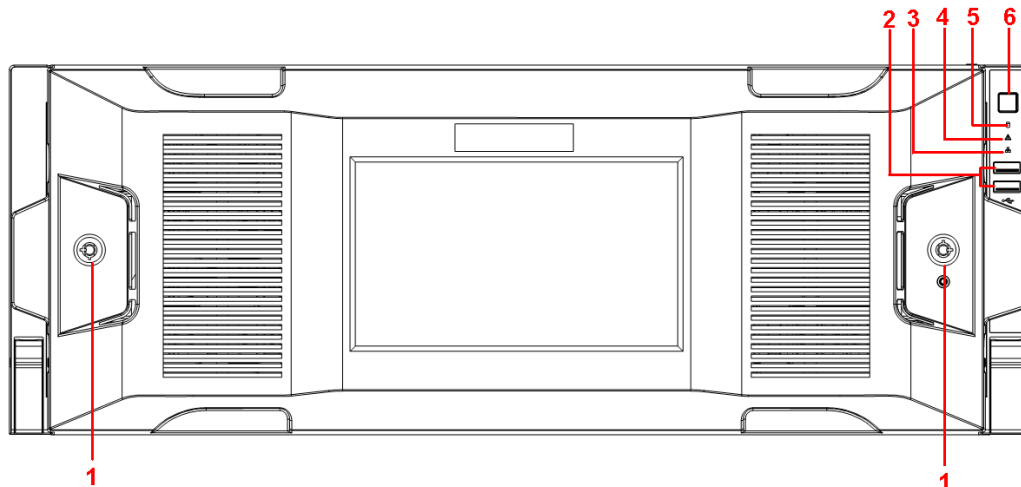









Figure 2-7

SN	Icon	Name	Function
1		Front panel lock	/
2		USB port	/
3		Network indicator light	The network indicator light is blue and it flashes when you connect the device to the network.
4		Alarm indicator light	The alarm indicator light becomes on once an alarm occurred. It becomes on via the software detection. The indicator light becomes on when there is a local alarm.
5		System HDD Indicator light	The blue light becomes on when system is reading or writing the system HDD. In the system HDD, there are device important configuration file, factory default configuration file, device initial boot up data.
6		Power button	Press it once to turn on the device. Press it for a long time to turn off the device ( <b>Usually we do not recommend</b> ).  Press power button for a long time or pull out the power cable may result in device auto restart.

After you remove the front panel, user may see there are 24 HDDs. From the left to the right and from the top to the bottom, it ranges from 1~4, 5~8, 9~12, 13~16, 17~20, 21~24. See Figure 2-8.

User may see there are two indicator lights on the HDD bracket.

- : The power indicator light is at the top. The light is yellow after you connected the device to the power.
- : The read-write indicator light is at the bottom. The blue light flashes when system is reading or writing the data.

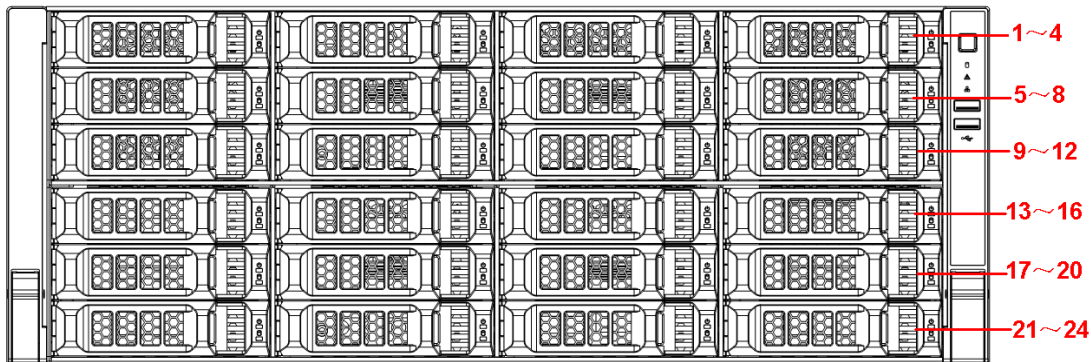

Figure 2-8

## 2.2 Rear Panel

### 2.2.1 DNA 3U NVR Series

The general series rear panel of DNA 3U NVR is shown as in Figure 2-9.

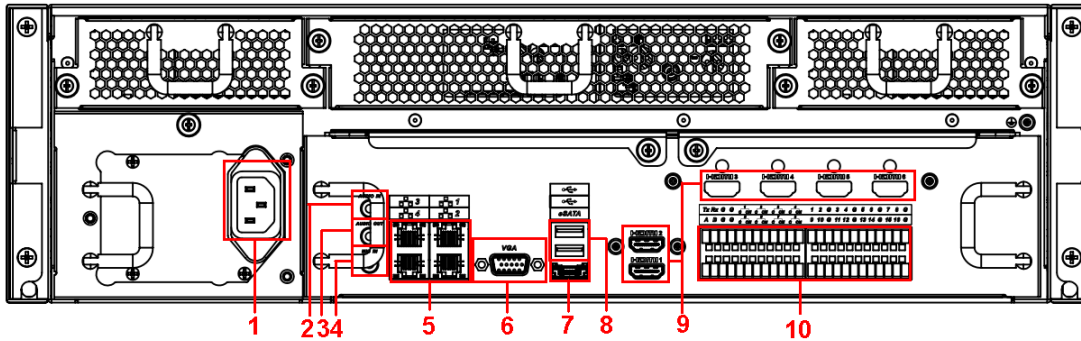

Figure 2-9

The redundant power series rear panel of DNA 3U NVR is shown as in Figure 2-10.

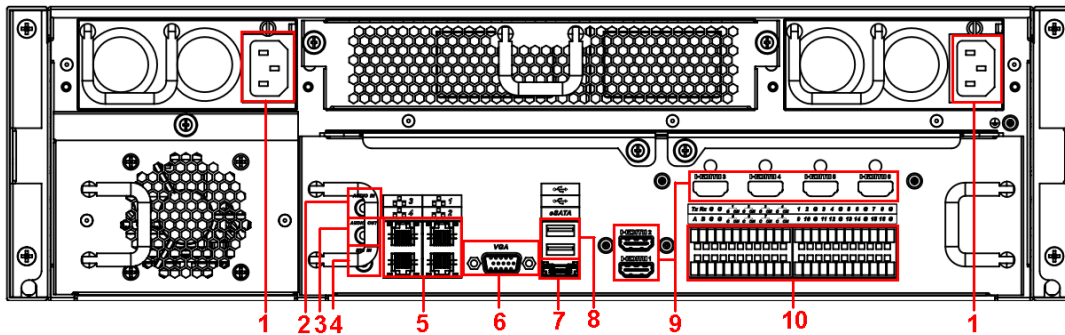

Figure 2-10

Please refer to the following sheet for rear detailed information.

SN	Function	SN	Function
1	Power socket	2	Audio Input
3	Audio output	4	Bidirectional talk input
5	Network port	6	Video VGA output
7	eSATA port	8	USB port
9	HDMI port	10	Alarm input/alarm output/RS485 port.

#### Important

**Right now, system does not support audio input port. System supports HDMI1/HDMI2 port by default. You need to purchase HDMI interface board if you want to use HDMI3-HDMI6 port.**

### 2.2.2 DNA 4K 2U/DNA 4K S2 2U NVR Series

The DNA 4K 32-channel 2U/ DNA 4K S2 32-channel 2U series rear panel is shown as in Figure 2-11.

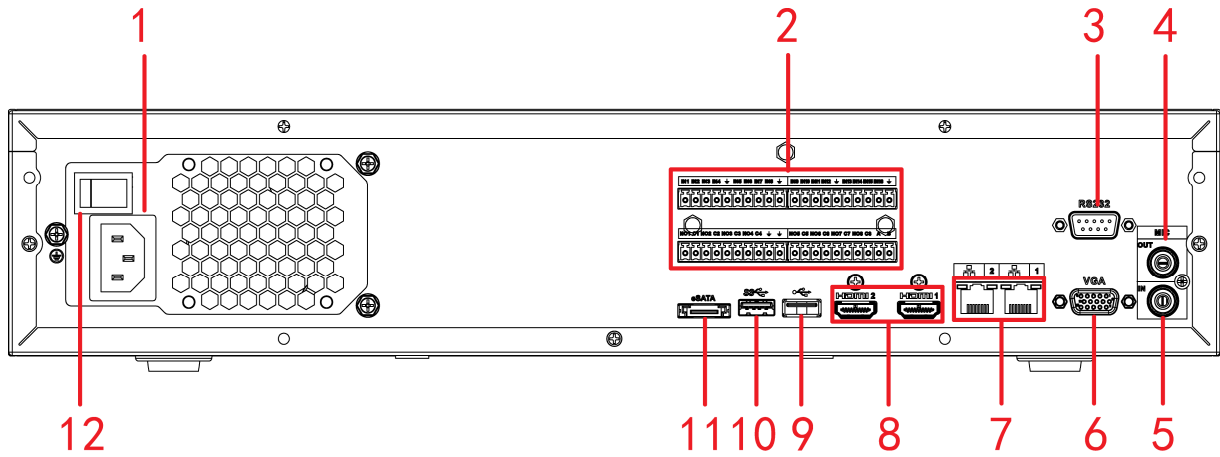

Figure 2-11

The DNA 4K 64-channel 2U/ DNA 4K 128-channel 2U/ DNA 4K S2 64-channel 2U/DNA 4K S2 128-channel 2U general series rear panel is shown as in Figure 2-12.

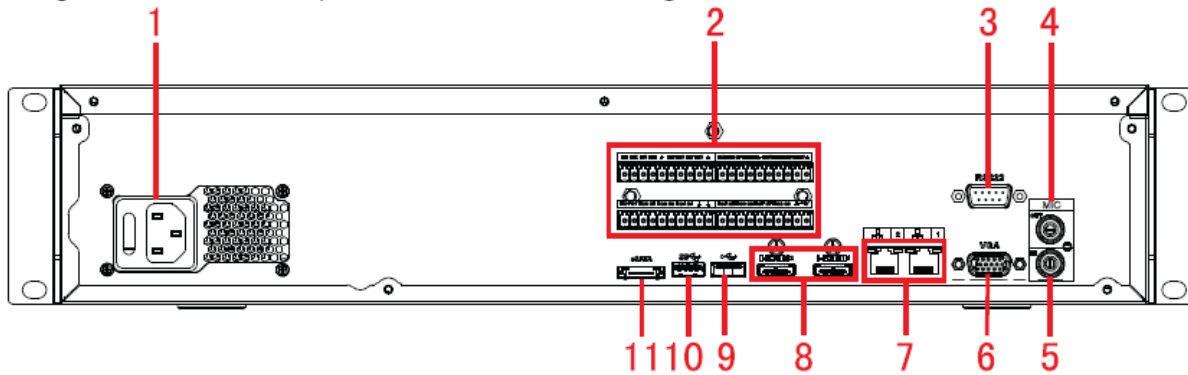

Figure 2-12

The DNA 4K 64-channel 2U/DNA 4K 128-channel 2U/ DNA 4K S2 64-channel 2U/DNA 4K S2 128-channel 2U redundant power series rear panel is shown as in Figure 2-13.

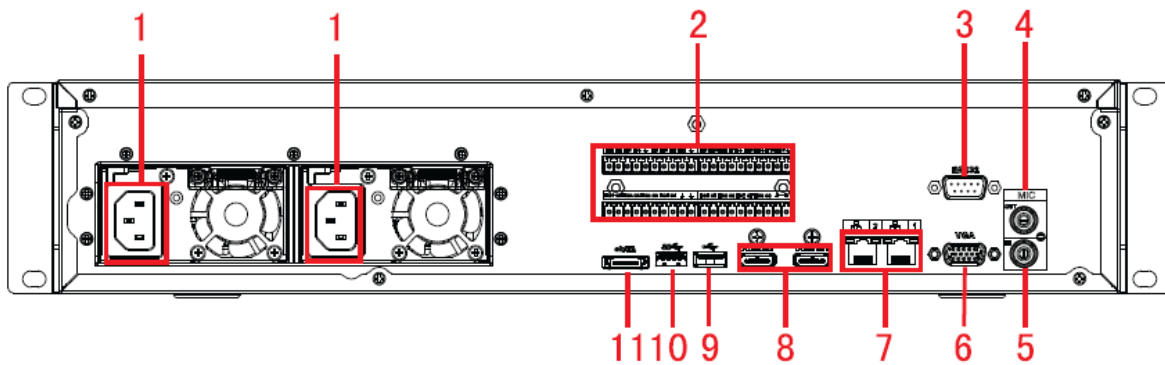

Figure 2-13

Please refer to the following sheet for detailed information.

SN	Function	SN	Function
1	Power socket	2	Alarm input/alarm output/RS485 port.
2	RS232 port	4	Audio output

5	Audio input	6	VGA port
7	Network port	8	HDMI port
9	USB 2.0 port	10	USB 3.0 port
11	eSATA port		

### 2.2.3 DNA 4K 3U NVR Series

The general series rear panel of DNA 4K 3U is shown as in Figure 2-14.

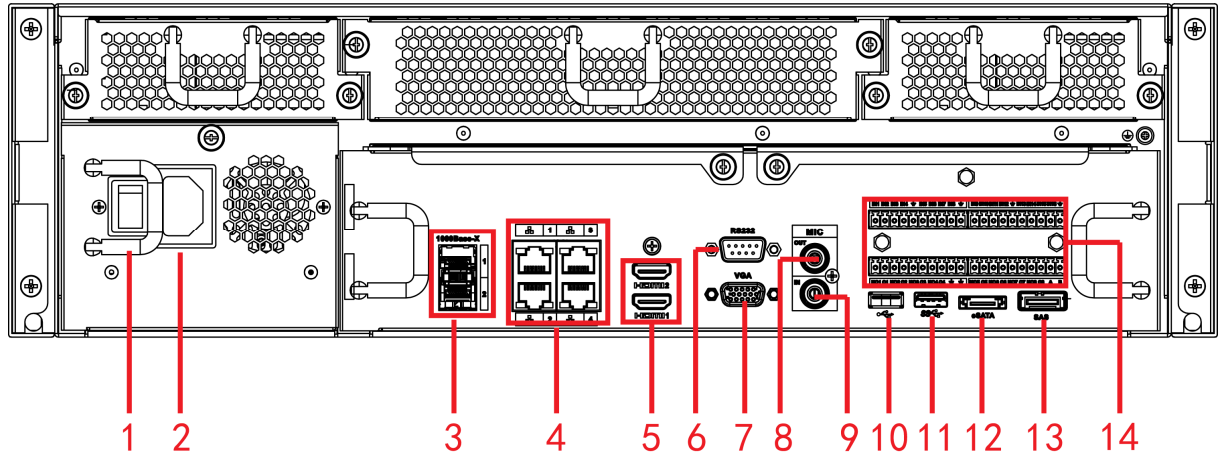

Figure 2-14

The redundant power series rear panel of DNA 4K 3U is shown as in Figure 2-15.

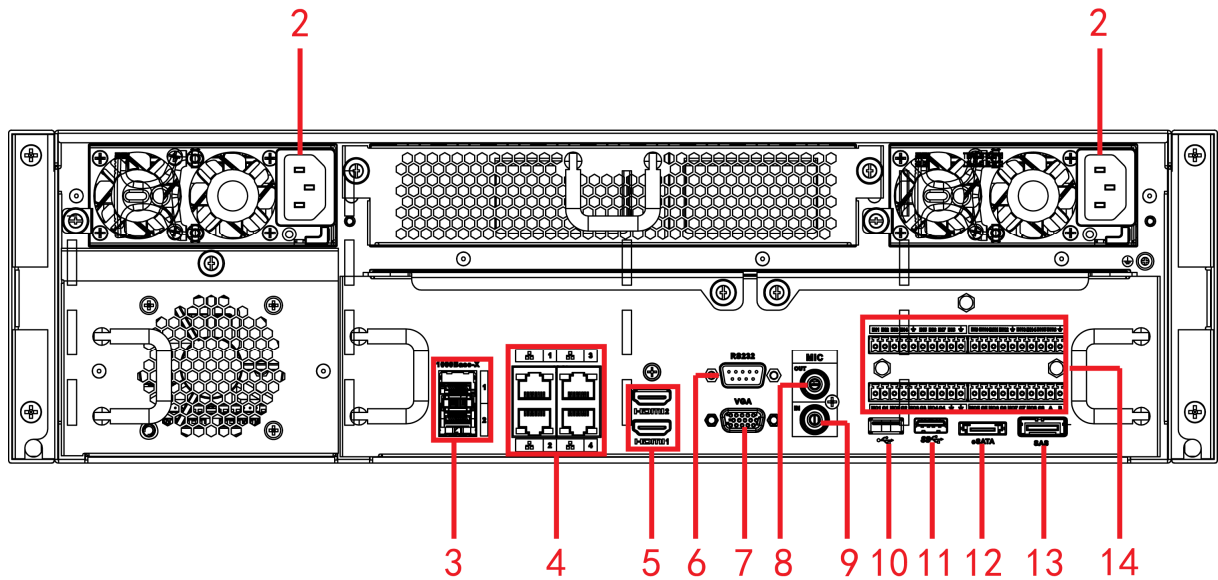

Figure 2-15

Please refer to the following sheet for rear detailed information.

SN	Name	SN	Name
1	Power on-off button	2	Power socket
3	1000M fiber port	4	Network port
5	HDMI port	6	RS232 port
7	Video VGA output	8	Audio output
9	Audio input	10	USB2.0 port

SN	Name	SN	Name
11	USB3.0 port	12	eSATA port
13	SAS extension port	14	Alarm input/output/RS485 port

### 2.2.4 DNA 4K S2 3U NVR Series

The general series rear panel of DNA 4K S2 3U is shown as in Figure 2-16.

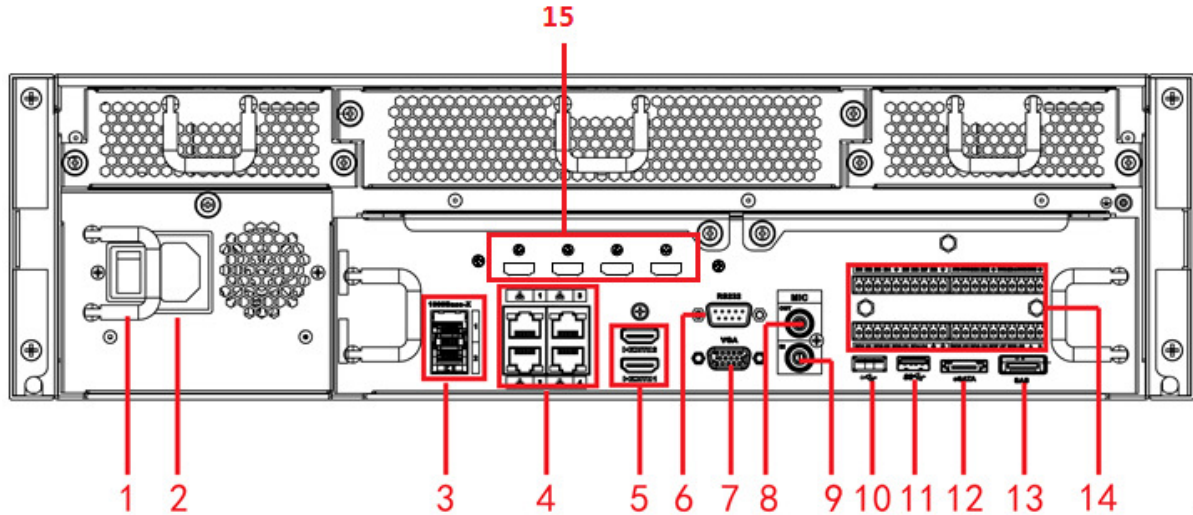

Figure 2-16

The redundant power series rear panel of DNA 4K S2 3U is shown as in Figure 2-17.

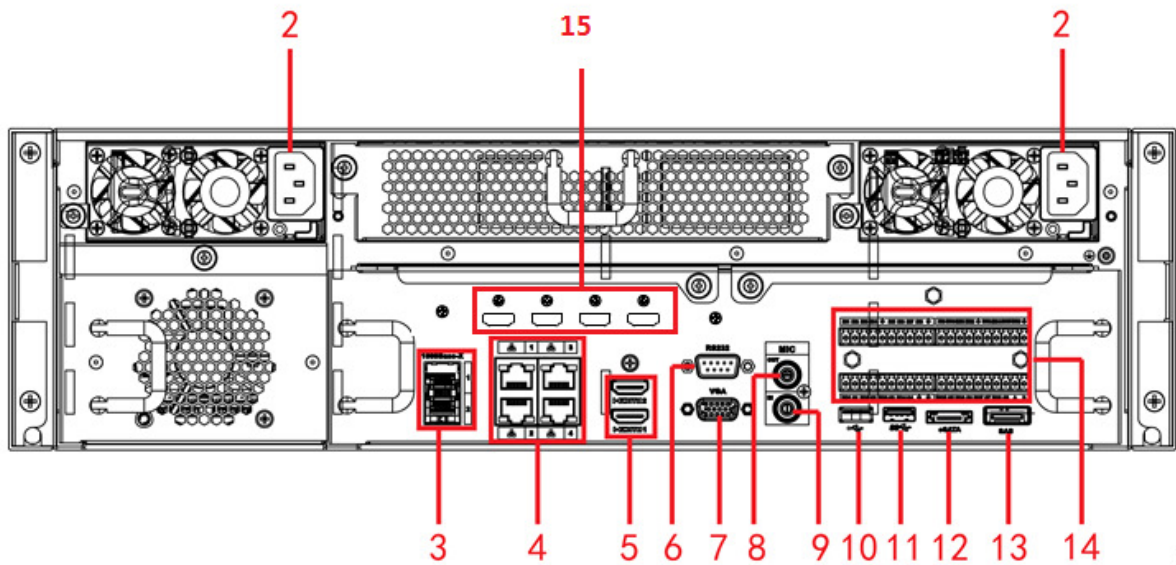

Figure 2-17

Please refer to the following sheet for rear detailed information.

SN	Name	SN	Name
1	Power on-off button	2	Power socket
3	1000M fiber port	4	Network port
5	HDMI port	6	RS232 port
7	Video VGA output	8	Audio output
9	Audio input	10	USB3.0 port



SN	Name	SN	Name
11	USB3.0 port	12	eSATA port
13	SAS extension port	14	Alarm input/output/RS485 port
15	HDMI port (The HD decode card is not the default accessory. Please purchase if you want to use)		

### 2.2.5 DNA 4U NVR Series

The general rear panel is shown as in Figure 2-18.

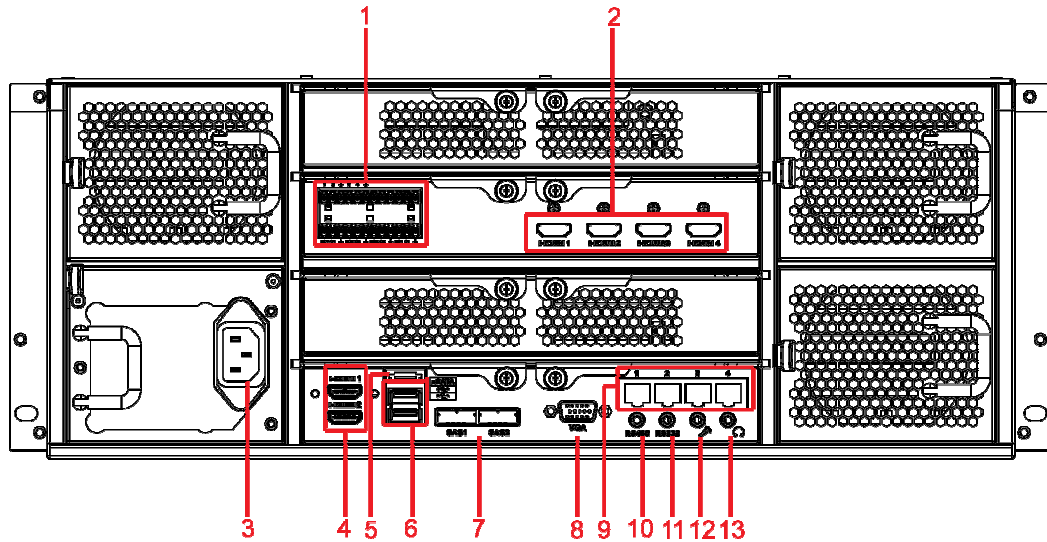

Figure 2-18

The redundant power series rear panel is shown as in Figure 2-19.

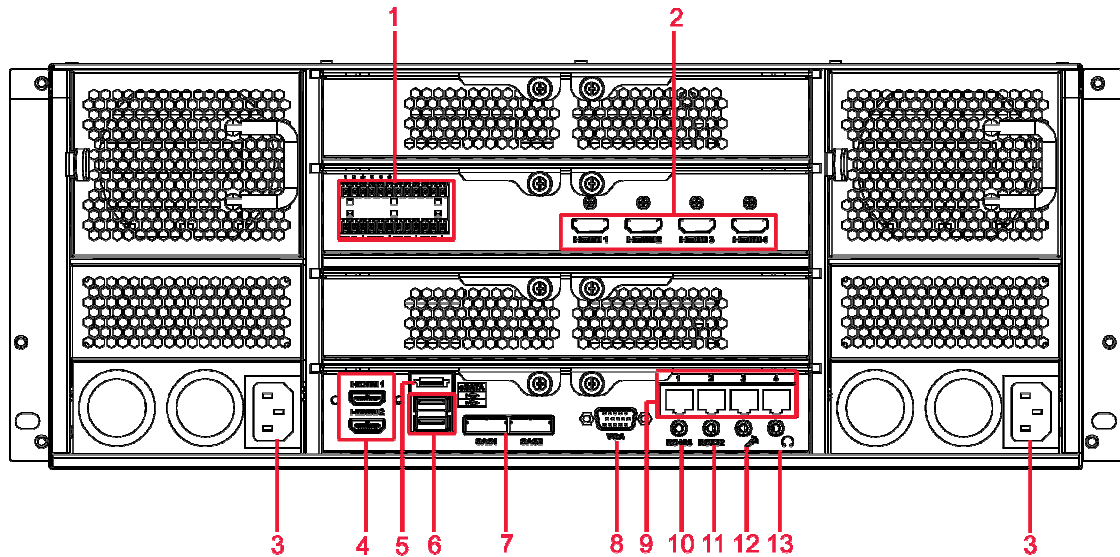

Figure 2-19

Please refer to the following sheet for detailed information.

SN	Name	SN	Name
1	Alarm input/alarm output	2	HDMI port (Reserved port. Right now system does not support HD decode card.)
3	Power port	4	HDMI port
5	eSATA port	6	USB port
7	SAS port	8	Video VGA output
9	Network port	10	RS485 port
11	RS232 port	12	Audio input port
13	Audio output port		

## 2.3 Alarm Connection

Please refer to the following sheet for alarm input and output connection.

There are two alarm input types for you to select: normal open (NO) and normal close (NC).

### 1. Alarm input

- a. Please make sure alarm input mode is grounding alarm input.
- b. Grounding signal is needed for alarm input.
- c. Alarm input needs the low level voltage signal.
- d. Alarm input mode can be either NC (normal Open) or NO (Normal Close)
- e. When you are connecting two NVRs or you are connecting one NVR and one other device, please use a relay to separate them.

### 2. Alarm output

The alarm output port should not be connected to high power load directly (It shall be less than 1A) to avoid high current which may result in relay damage. Please use the co contactor to realize the connection between the alarm output port and the load.

### 3. Please make sure the front-end device has soundly earthed.

Improper grounding may result in chip damage.

#### 2.3.1 Alarm input and output details

##### 2.3.1.1 DNA 3U NVR /DNA 4K 3U/DNA 4K S2 3U Series

User may refer to the following sheet for alarm input and output information. See Figure 2-20.

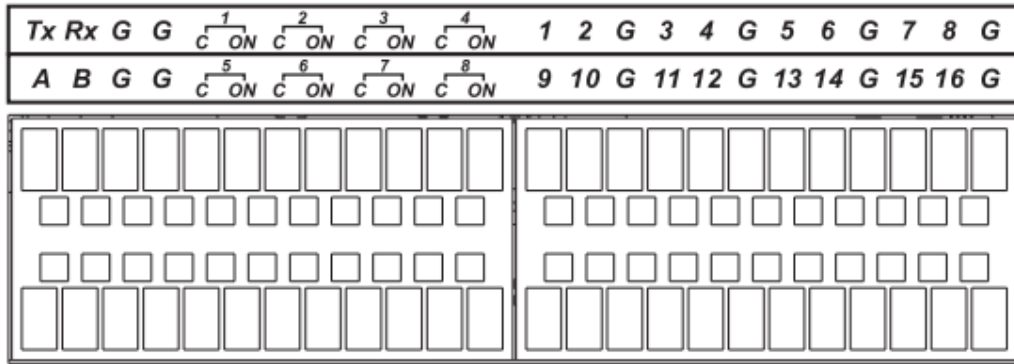

Figure 2-20

Icon	Note
1, 2, 3, 4, 5, 6, 7, 8, 9, 10, 11, 12, 13, 14, 15, 16	ALARM 1 to ALARM 16. The alarm becomes active in low voltage.
1-ON C, 2-ON C, 3-ON C, 4-ON C, 5-ON C, 6-ON C, 7-ON C, 8-ON C	Eight groups of normal open activation output (on/off button)
G	GND cable.
A/B	The A/B cable to control the RS485 devices. It is to connect to control devices such as PTZ dome camera. 120Ω should be parallel connected between A, B lines on the far end to reduce reflection and guarantee the signal quality.
Tx and Rx	RS232 port. Tx is the data output cable and the Rx is the data input cable.

### 2.3.1.2 DNA 4K 2U/DNA 4K S2 2U Series

User may refer to the following sheet for alarm input and output information. See Figure 2-21.

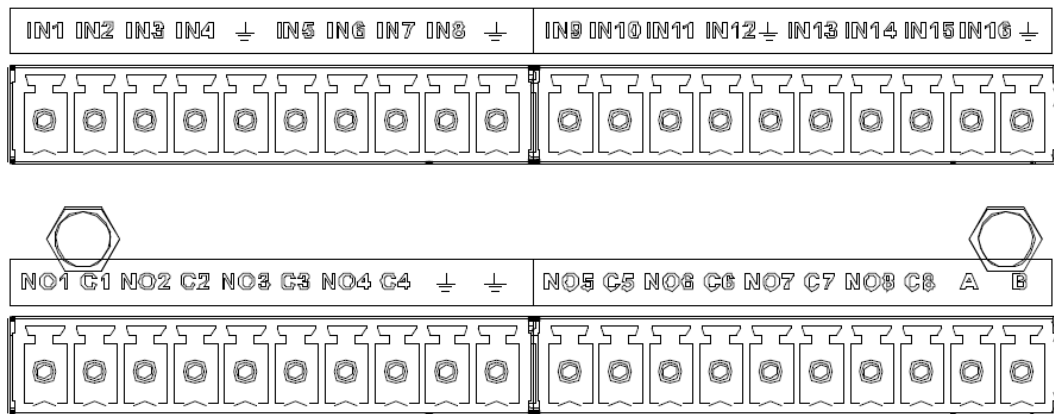

Figure 2-21

Icon	Note
------	------

1, 2, 3, 4, 5, 6, 7, 8, 9, 10, 11, 12, 13, 14, 15, 16	ALARM 1 to ALARM 16. The alarm becomes active in low voltage.
1-ON C, 2-ON C, 3-ON C, 4-ON C, 5-ON C, 6-ON C, 7-ON C, 8-ON C	Eight groups of normal open activation output (on/off button)
⏏	GND cable.
A/B	The A/B cable to control the RS485 devices. It is to connect to control devices such as PTZ dome camera. 120Ω should be parallel connected between A, B lines on the far end to reduce reflection and guarantee the signal quality.

### 2.3.1.3 DNA 4U NVR Series

User may refer to the following sheet for alarm input and output information. See Figure 2-22.

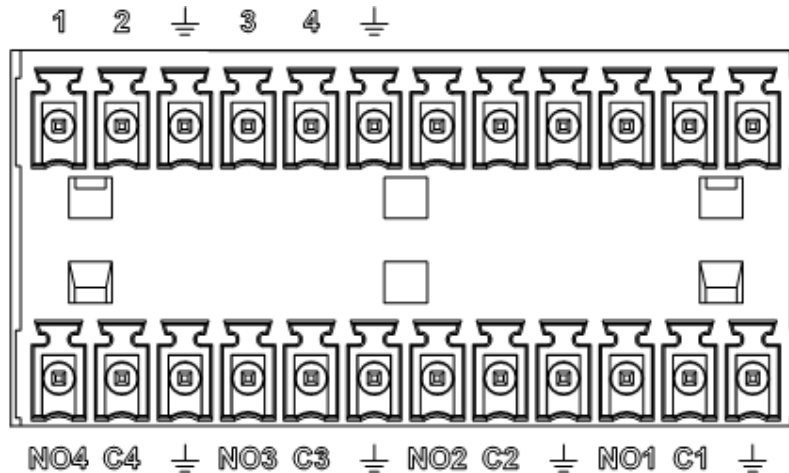

Figure 2-22

Icon	Note
1~4	ALARM 1 to ALARM 4. The alarm becomes active in low voltage.
NO1 C1, NO2 C2, NO3 C3, NO4 C4	Four groups of normal open activation output (on/off button)
⏏	GND

### 2.3.2 Alarm Input and Output Port

Please refer to the following sheet for more information.

- Grounding alarm inputs. Normal open or Normal close type)
- Please parallel connect COM end and GND end of the alarm detector (Provide external power to the alarm detector).
- Please parallel connect the Ground of the NVR and the ground of the alarm detector.
- Please connect the NC port of the alarm sensor to the NVR alarm input(ALARM)
- Use the same ground with that of NVR if you use external power to the alarm device.

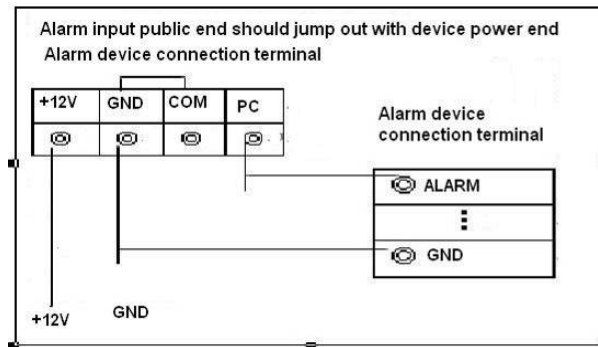

Figure 2-23

### 2.3.3 Alarm Output Port

- Provide power to peripheral alarm device.
- To avoid overloading, please read the following relay parameters sheet carefully.
- RS485 A/B cable is for the A/B cable of the PTZ decoder.

### 2.3.4 Alarm relay specifications

Model:	<b>JRC-27F</b>	
Material of the contact	Silver	
Rating value (Resistance load)	Contact load	30V DC 1A, 125V AC 0.5A
	Maximum switch power	62.5VA/30W
	Maximum switch voltage	125V AC, 60V DC
	Maximum switch current	2A
Insulation	Between loop and the contact	1000V AC 1 minue
	Between breaking contact	400V AC 1 minue
Insulation voltage	1000M $\Omega$ (500V DC)	
Opening time	< 5ms	
Closing time	< 5ms	
Longevity	Mechanical	300/1 minue
	Electrical	30/1 minute
Working Temperature	-30 $\square$ ~+70 $\square$	

## 2.4 Remote Control

The remote control interface is shown as in Figure 2-24.

Please note remote control is not our standard accessory and it is not included in the accessory bag.

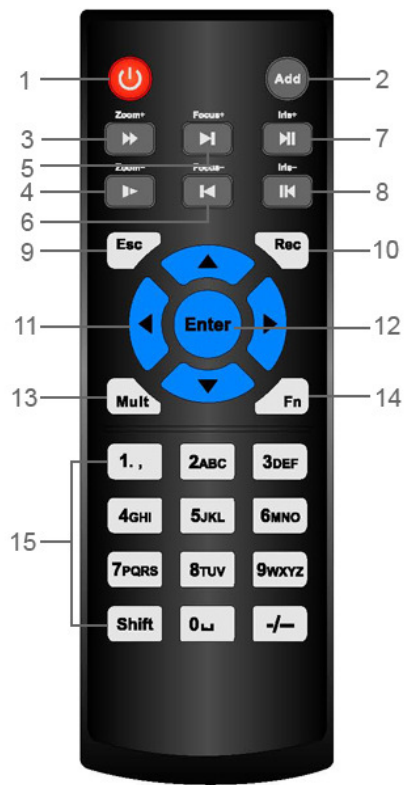

Figure 2-24

Serial Number	Name	Function
1	Power button	Click it to boot up or shut down the device.
2	Address	Click it to input device number, so that user may control it.
3	Forward	Various forward speeds and normal speed playback.
4	Slow play	Multiple slow play speeds or normal playback.
5	Next record	In playback mode, playback the next video.
6	Previous record	In playback mode, playback the previous video.
7	Play/Pause	In pause mode, click this button to realize normal playback. In normal playback click this button to pause playback. In real-time monitor mode, click this button to enter video search menu.
8	Reverse/pause	Reverse playback pause mode, click this button to realize normal playback.

		In reverse playback click this button to pause playback.
9	Esc.	Go back to previous menu or cancel current operation (close upper interface or control)
10	Record	Start or stop record manually In record interface, working with the direction buttons to select the record channel. Click this button for at least 1.5 seconds, system can go to the Manual Record interface.
11	Direction keys	Switch current activated control, go to left or right. In playback mode, it is to control the playback process bar. Aux function(such as switch the PTZ menu)
12	Enter /menu key	go to default button go to the menu
13	Multiple-window switch	Switch between multiple-window and one-window.
14	Fn	In 1-ch monitor mode: pop up assistant function: PTZ control and Video color.
		Switch the PTZ control menu in PTZ control interface.
		In motion detection interface, working with direction keys to complete setup.
		In text mode, click it to delete character.
15	0-9 number key	Input password, channel or switch channel.
		Shift is the button to switch the input method.

## 2.5 Mouse Operation

Please refer to the following sheet for mouse operation instruction.

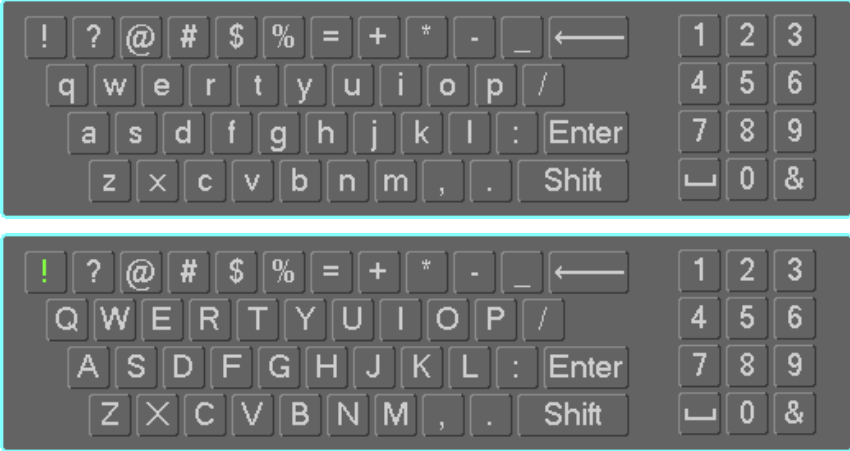

Left click mouse	When you have selected one menu item, left click mouse to view menu content.
	Modify checkbox or motion detection status.
	Click combo box to pop up dropdown list

	<p>In input box, user may select input methods. Left click the corresponding button on the panel user may input numeral/English character (small/capitalized). Here ← stands for backspace button. _ stands for space button.</p> <p>In English input mode: _stands for input a backspace icon and ← stands for deleting the previous character.</p>  <p>In numeral input mode: _ stands for clear and ← stands for deleting the previous numeral.</p>
Double left click mouse	<p>Implement special control operation such as double click one item in the file list to playback the video.</p> <p>In multiple-window mode, double left click one channel to view in full-window. Double left click current video again to go back to previous multiple-window mode.</p>
Right click mouse	<p>In real-time monitor mode, pops up shortcut menu.</p> <p>Exit current menu without saving the modification.</p>
Press middle button	<p>In numeral input box: Increase or decrease numeral value.</p> <p>Switch the items in the check box.</p> <p>Page up or page down</p>
Move mouse	Select current control or move control
Drag mouse	<p>Select motion detection zone</p> <p>Select privacy mask zone.</p>

## 2.6 Mouse Control

Left click mouse	System pops up password input dialogue box if you have not logged in.
	In real-time monitor mode, user may go to the main menu.
	When you have selected one menu item, left click mouse to view menu content.
	Implement the control operation.
	Modify checkbox or motion detection status.
	Click combo box to pop up drop down list

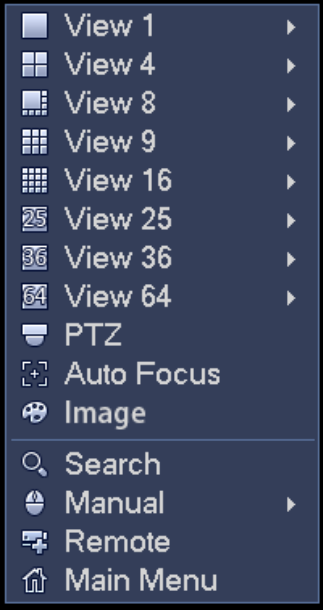

	<p>In input box, user may select input methods. Left click the corresponding button on the panel user may input numeral/English character (small/capitalized). Here ← stands for backspace button. _ stands for space button.</p> <p>In English input mode: _stands for input a backspace icon and ← stands for deleting the previous character.</p>  <p>In numeral input mode: _ stands for clear and ← stands for deleting the previous numeral.</p> <p>When input special sign, user may click corresponding numeral in the front panel to input. For example, click numeral 1 user may input“/” , or user may click the numeral in the on-screen keyboard directly.</p> 
<p>Double left click mouse</p>	<p>Implement special control operation such as double click one item in the file list to playback the video.</p> <p>In multiple-window mode, double left click one channel to view in full-window. Double left click current video again to go back to previous multiple-window mode.</p>

Right click mouse	<p>In real-time monitor mode, pops up shortcut menu: one-window, four-window, nine-window and sixteen-window, Pan/Tilt/Zoom, color setting, search, record, alarm input, alarm output, main menu.</p> <p>Among which, Pan/Tilt/Zoom and color setting applies for current selected channel.</p> <p>If you are in multiple-window mode, system automatically switches to the corresponding channel.</p>  <p>Exit current menu without saving the modification.</p>
Press middle button	<p>In numeral input box: Increase or decrease numeral value.</p> <p>Switch the items in the check box.</p> <p>Page up or page down</p>
Move mouse	Select current control or move control
Drag mouse	<p>Select motion detection zone</p> <p>Select privacy mask zone.</p>

## 3 Local Basic Operation

### 3.1 Boot up and Shutdown

#### 3.1.1 Boot up



#### Caution

Before the boot up, please make sure:

- For device security, please connect the NVR to the power adapter first and then connect the device to the power socket.
- The rated input voltage matches the device power on-off button. Please make sure the power wire connection is OK. Then click the power on-off button.
- Always use the stable current, if necessary UPS is a best alternative measure.

Please follow the steps listed below to boot up the device.

- Connect the device to the monitor and then connect a mouse.
- Connect power cable.
- Click the power button at the front or rear panel and then boot up the device. After device booted up, the system is in multiple-channel display mode by default.

#### 3.1.2 Shutdown

##### Note

- When you see corresponding dialogue box “System is shutting down...” Do not click power on-off button directly.
- Do not unplug the power cable or click power on-off button to shutdown device directly when device is running (especially when it is recording.)

There are three ways for you to log out.

- a) Main menu (**RECOMMENDED**)

From Main Menu->Shutdown, select shutdown from dropdown list.

Click OK button, user may see device shuts down.

- b) From power on-off button on the front panel or remote control

Press the power on-off button on the NVR front panel or remote control for more than 3 seconds to shutdown the device.

- c) From power on-off button on the rear panel.

### 3.2 Change/Reset Password

#### 3.2.1 Change Password

**For your own safety, please change your administrator default password after your first login.**

After system booted up, user may see the following interface if it is your first login or you have restored default setup. See Figure 3-1. Please input old password and then input new password twice to confirm the change.

- The default administrator user name is **admin** and the password is **admin**.
- User may set security questions here to reset the password in case you forgot. System supports customized setup. Please note you need to set two security questions at the same time. When you

reset the password, you need to answer these two security questions too.

- For reset information, please refer to chapter 3.2.2.



The image shows a dark-themed administrator interface for password reset. At the top, there is a header labeled "ADMINISTRATOR". Below it, the form includes the following fields: "User Name" with a dropdown menu showing "admin"; "Old Password" with a text input field; "New Password" with a text input field and a red strength indicator below it; "Confirm Password" with a text input field; "Secure Questions (Optional)" section containing two questions: "Question 1" with a dropdown menu showing "What's your favorite pet?" and an "Answer" text input field; and "Question 2" with a dropdown menu showing "What's your first car model?" and an "Answer" text input field. At the bottom of the form are "OK" and "Cancel" buttons.

Figure 3-1

Click Cancel button, system pops up the following interface for you to confirm. See Figure 3-2. Check the box here, system will not pop up the change password interface the next time.

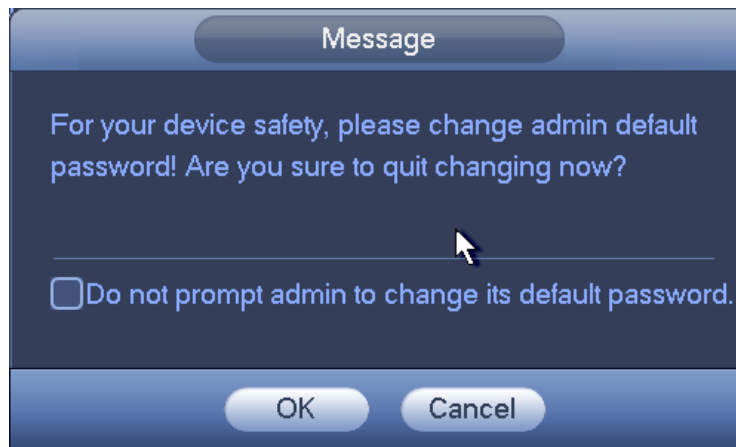

The image shows a "Message" dialog box with a dark background. The text inside reads: "For your device safety, please change admin default password! Are you sure to quit changing now?". Below the text is a horizontal line and a checkbox. The checkbox is currently unchecked, and the text next to it says "Do not prompt admin to change its default password.". At the bottom of the dialog are "OK" and "Cancel" buttons.

Figure 3-2

### 3.2.2 Reset Password

Once you forgot password, user may answer the security questions you set in chapter 3.2.1 to reset the password.

In login interface, click . See Figure 3-7.

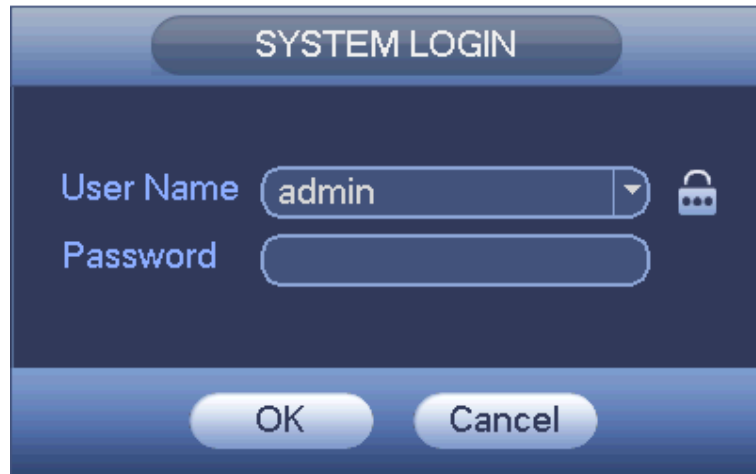

Figure 3-3

System pops up the following dialogue box, please answer the security questions and then input the new password twice. See Figure 3-4.

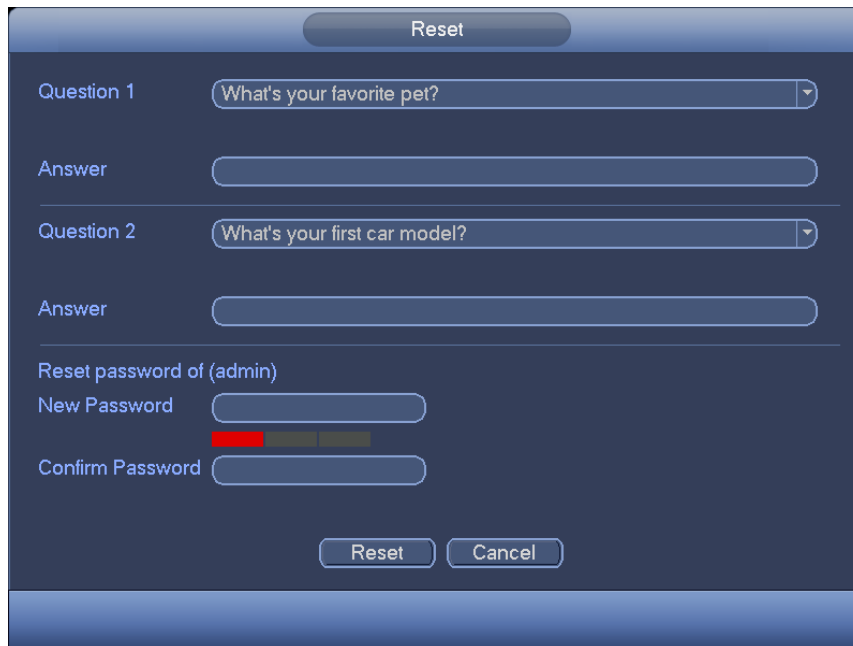

Figure 3-4

**Tips**

User may go to main menu->Setting->System->Account->Secure question to set.

### 3.3 Startup Wizard

After device successfully booted up, it goes to startup wizard.

Click Cancel/Next button, user may see system goes to login interface.

**Tips**

Check the box Startup button here, system goes to startup wizard again when it boots up the next time.

Cancel the Startup button, system goes to the login interface directly when it boots up the next time.



Figure 3-5

Click Cancel button or Next Step button, system goes to login interface. See Figure 3-6.

System consists of three accounts:

- Username: **admin**. Password: **admin**. (administrator, local and network)
- Username: **888888**. Password: **888888**. (administrator, local only)
- Username: **default**. Password: **default** (hidden user). Hidden user “default” is for system interior use only and can not be deleted. When there is no login user, hidden user “default” automatically login. User may set some rights such as monitor for this user so that user may view some channel view without login.

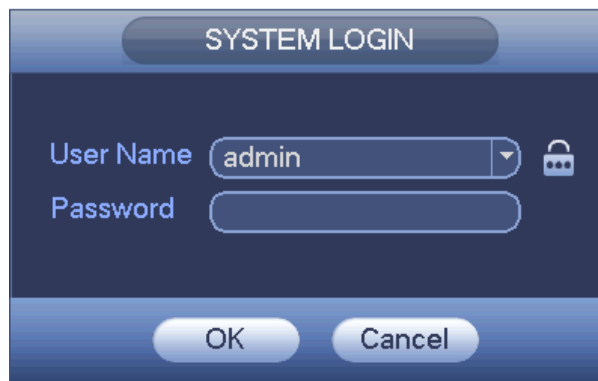

Figure 3-6

**Note:**

**For security reason, please modify password after you first login.**

Within 30 minutes, three times login failure will result in system alarm and five times login failure will result in account lock!

Click OK button, user may go to General interface. See Figure 3-7.

For detailed information, please refer to chapter 3.17.1.



Figure 3-7

Click Next button, user may go to network interface. See Figure 3-8.  
For detailed information, please refer to chapter 3.15.



Figure 3-8

Click Next button, user may go to remote device interface. See Figure 3-9.  
For detailed information, please refer to chapter 3.5.



Figure 3-9

Click Next button, user may go to RAID interface. See Figure 3-10.  
For detailed information, please refer to chapter 3.16.4.

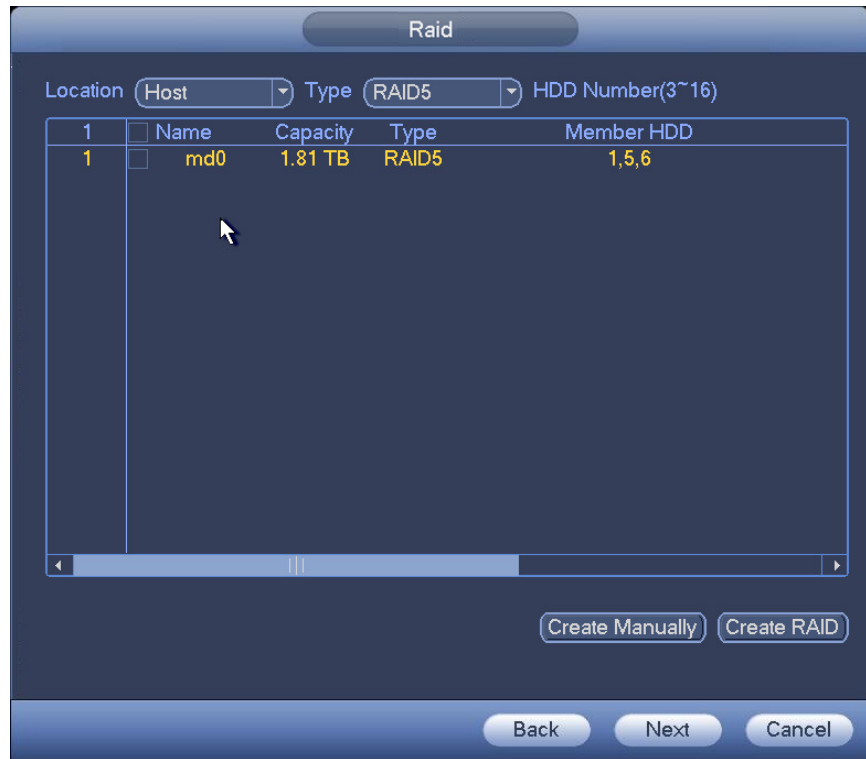

Figure 3-10



Click Next button, user may go to Schedule interface. See Figure 3-11.  
 For detailed information, please refer to chapter 3.11.2.

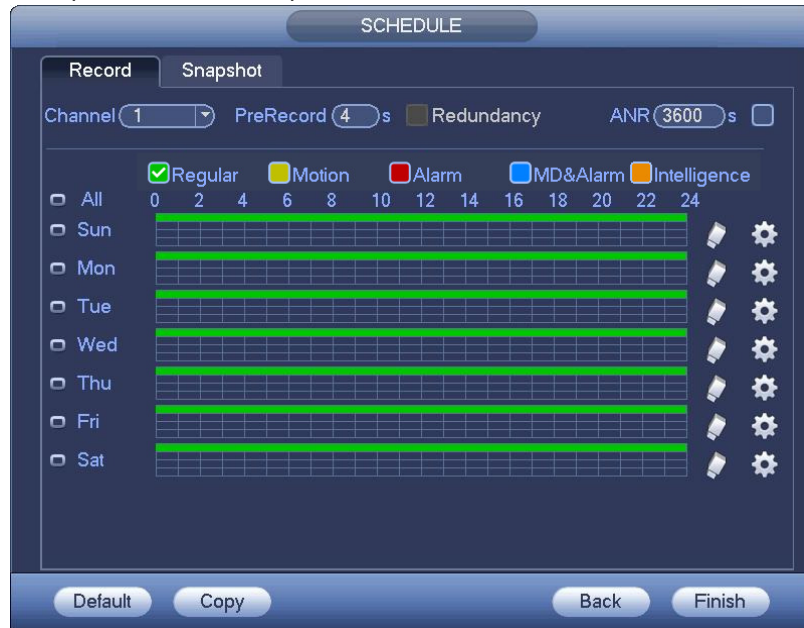

Figure 3-11

Click Finish button, system pops up a dialogue box. Click the OK button, the startup wizard is complete. See Figure 3-12.

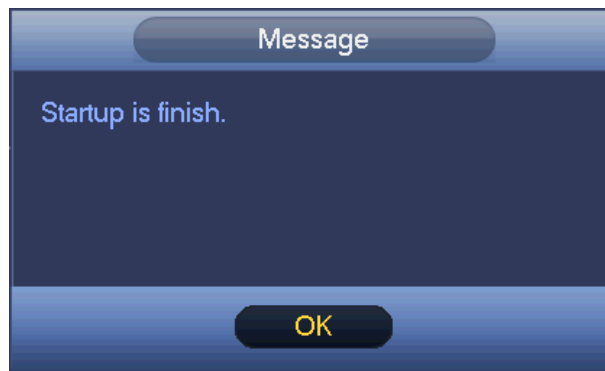

Figure 3-12

### 3.4 Navigation Bar

You need to go to the Main menu->Setting->System->General to enable navigation bar function; otherwise user may not see the following interface.

The navigation bar is shown as below. See Figure 3-13.



Figure 3-13

### 3.4.1 Main Menu

Click button  to go to the main menu interface.

### 3.4.2 Dual-screen operation

#### Important

This function is for some series only.

Click  to select screen 2, user may view an interface shown as below. See Figure 3-14. It is a navigation bar for screen 2.



Figure 3-14

Click any screen split mode; HDMI2 screen can display corresponding screens. Now user may control two screens. See Figure 3-15.



Figure 3-15



#### Note

- Screen 2 function is null if tour is in process. Please disable tour function first.
- Right now, the screen 2 operation can only be realized on the navigation bar. The operations on the right-click menu are for screen 1 only.

### 3.4.3 Output Screen

Select corresponding window-split mode and output channels.

### 3.4.4 Tour

Click button  to enable tour, the icon becomes , user may see the tour is in process.

### 3.4.5 PTZ

Click , system goes to the PTZ control interface. Please refer to chapter 3.10.2.

### 3.4.6 Color

Click button , system goes to the color interface. Please refer to chapter 3.5.3.

**Please make sure system is in one-channel mode.**

### 3.4.7 Search

Click button , system goes to search interface. Please refer to chapter 3.12.2

### 3.4.8 Audio Broadcast

Click , user may go to the audio broadcast interface. Please refer to chapter 3.12.2.

### 3.4.9 Alarm Status

Click button , system goes to alarm status interface. It is to view device status and channel status. Please refer to chapter 3.20.1.5.

### 3.4.10 Channel Info

Click button , system goes to the channel information setup interface. It is to view information of the corresponding channel. See Figure 3-16.



The screenshot shows a window titled "CHANNEL INFO" with a table of channel data. The table has columns for Channel, Motion Detect, Video Loss, Tampering, Record Status, Bit Rate(Kb/S), Status, and Record Mode. The data is as follows:

Channel	Motion Detect	Video Loss	Tampering	Record Status	Bit Rate(Kb/S)	Status	Record Mode
1	--	--	--	■	0	●	Regular
2	--	--	--	■	0	●	Regular
3	--	--	--	■	0	●	Regular
4	--	--	--	■	0	●	Regular
5	--	--	--	■	0	●	Regular
6	--	--	--	■	0	●	Regular
7	--	--	--	■	0	●	Regular
8	--	--	--	■	0	●	Regular
9	--	--	--	■	0	●	Regular
10	--	--	--	■	10723	●	Regular
11	--	--	--	■	0	●	Regular
12	--	--	--	■	0	●	Regular
13	--	--	--	■	1116	●	Regular
14	--	--	--	■	0	●	Regular

At the bottom of the window, there is a "Refresh" button.

Figure 3-16

### 3.4.11 Remote Device

Click , system goes to the remote device interface. Please refer to chapter 3.5.

### 3.4.12 Network

Click , system goes to the network interface. It is to set network IP address, default gateway and etc. Please refer to chapter 3.15.

### 3.4.13 HDD Manager

Click , system goes to the HDD manager interface. It is to view and manage HDD information. Please refer to chapter 3.16.1.

### 3.4.14 USB Manager



Click , system goes to the USB Manager interface. See Figure 3-17. It is to view USB information, backup and update. Please refer to chapter 3.13.1 file backup, chapter 3.13.3 backup log, chapter 3.13.2 import/export, and chapter 3.20.4 upgrade for detailed information.



Figure 3-17

### 3.4.15 System Status

Click , user may go to the following interface. See Figure 3-18. Here user may view host information, RAID information, HDD information, HDD usage rate, fan speed, CPU usage, CPU temperature, memory usage, power information and etc.

The following interface for reference only.



Figure 3-18

### 3.4.16 Device Tree

Click , user may go to the following interface. See Figure 3-19. User may view channel list and device list.

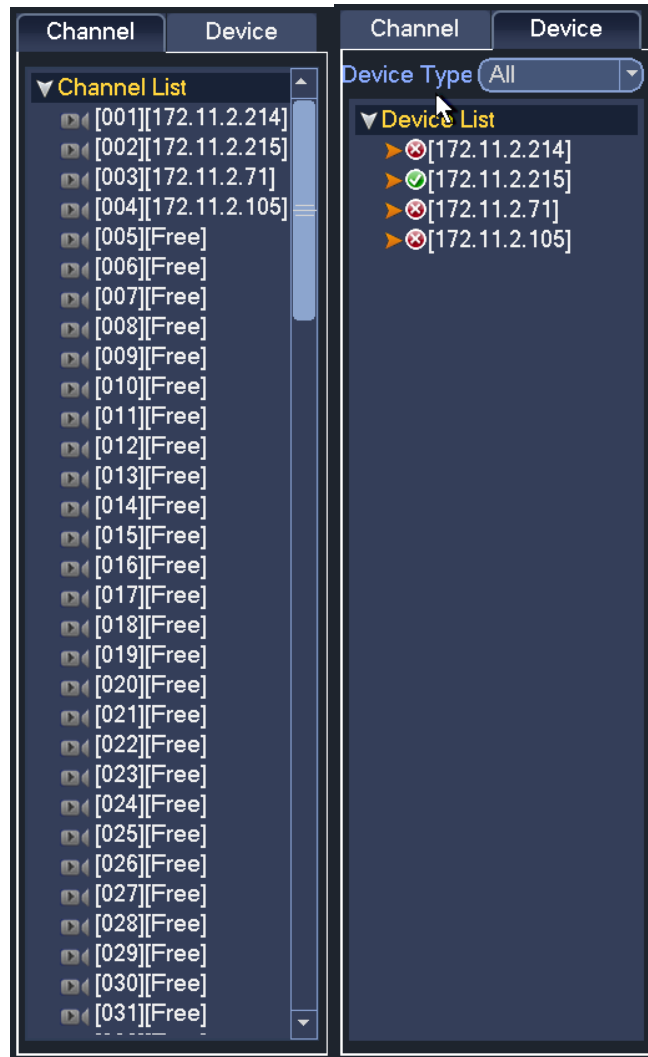

Figure 3-19

## 3.5 Remote Device

### 3.5.1 Remote Device Connection

From Main menu->Setting->Camera->Remote->Remote or right click mouse on the preview interface and then select Remote item, user may see the following interface. See Figure 3-20.



Figure 3-20

### Search remote device

Click Device search button, user may view the searched IP addresses at the top pane of the interface.

#### Note

- User may use IP address or MAC address to search device. System supports fuzzy search.
- For the device in the added device list, user may not see it at the top pane of the interface.
- Click , user may view the video of current camera.

Double click an IP address or check one or more IP address (es) at the same time and then click Add button, user may add current device to the added devices at the bottom pane of the interface. System supports batch add function.

### Add remote device

Click Manual Add button, user may add a device directly. Here user may set TCP/UPD/auto connection mode. The default setup is TCP. See Figure 3-21.

- Manufacturer: Select the manufacture from the dropdown list.
- IP address: Input remote IP address.
- TCP port: Input TCP port value.
- User name: Input the user name you login the remote device.
- Password: Input the password you login the remote device.
- Channel amount: It is to display channel total amount. Click Set button to set remote device channel so that user may control remotely.
- Remote channel amount: The channel mount of the remote device.
- Channel: The channel mount of current device. It is the channel amount you want to view the remote device.

- Decode buffer: Please select from the dropdown list: default/realtime/fluency.

### Important

Please note the manual add function is for Dante, Panasonic, Sony, Dynacolor, Samsung, AXIS, Arecont, ONVIF and Custom. When the type is the custom, user may just input URL address, user name and password connect to the network camera without considering network camera manufacture. Please contact your network camera manufacturer for the URL address.

Figure 3-21

### Change IP address

On the searched devices list, check one or more device(s) at the same time. Click Modify IP button , user may see the following interface. See Figure 3-22.

- DHCP: Check the box here, system can auto allocate the IP address. The IP address, subnet mask, default gateway are reference only.
- Static: Check the box here, user may set IP address, subnet mask, default gateway manually.
- IP address/subnet mask/default gateway: User may input corresponding information here.
- User name/password: The account you login the remote device. Please input here to password verification to change the remote device password.
- Incremental value: When you want to change several IP addresses, once you input the IP address of the first device, the IP address of the next device will increase accordingly. For example, when the incremental value is 1, if the IP address of the first device is 172.10.3.128, the IP address of the second device will auto be set as 172.10.3.129.

### Note

- For the static IP address, system will alert you if there is any IP conflict. If you are changing several IP addresses at the same time, system auto skip the conflicted IP and auto allocate again according to the incremental value you set.

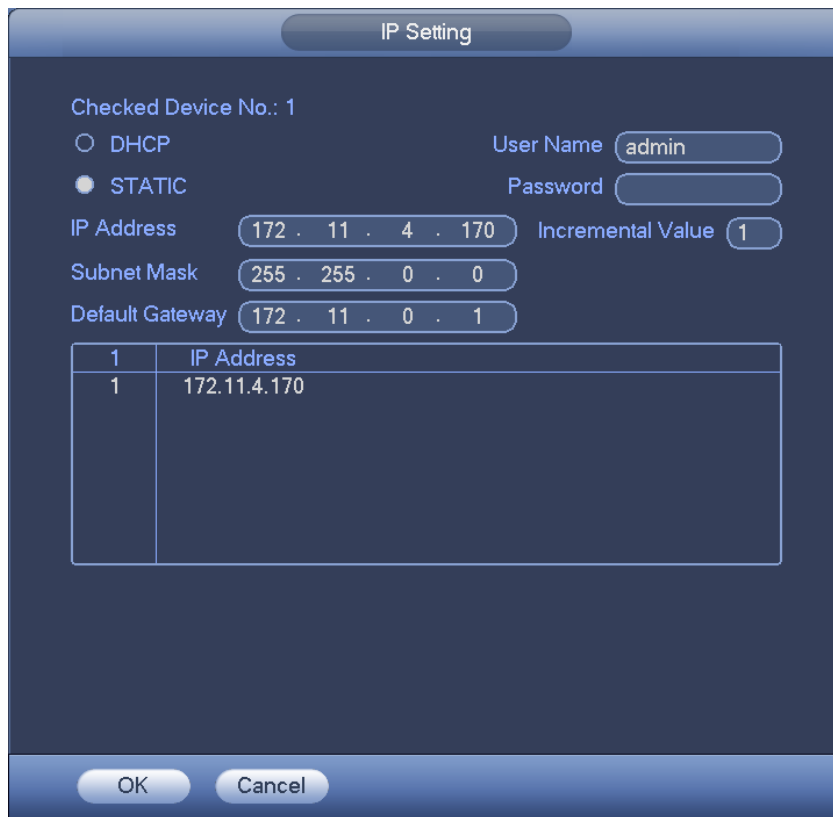

Figure 3-22

### Export IP

User may export the list of the added devices to your local PC.

Insert UBS device and then click Export button, user may see the following interface. See Figure 3-23.



Figure 3-23



Select the saved path and click OK.

User may see “Backup completed ” prompt. See Figure 3-24.



Figure 3-24

**Note**

The export file extension name is .CVS. The file contains IP address, port, remote channel No. manufacturer, user name, password and etc.

**Import IP**

User may import the added device list to add the device conveniently.

Click Import button, user may go to the following interface. See Figure 3-25.

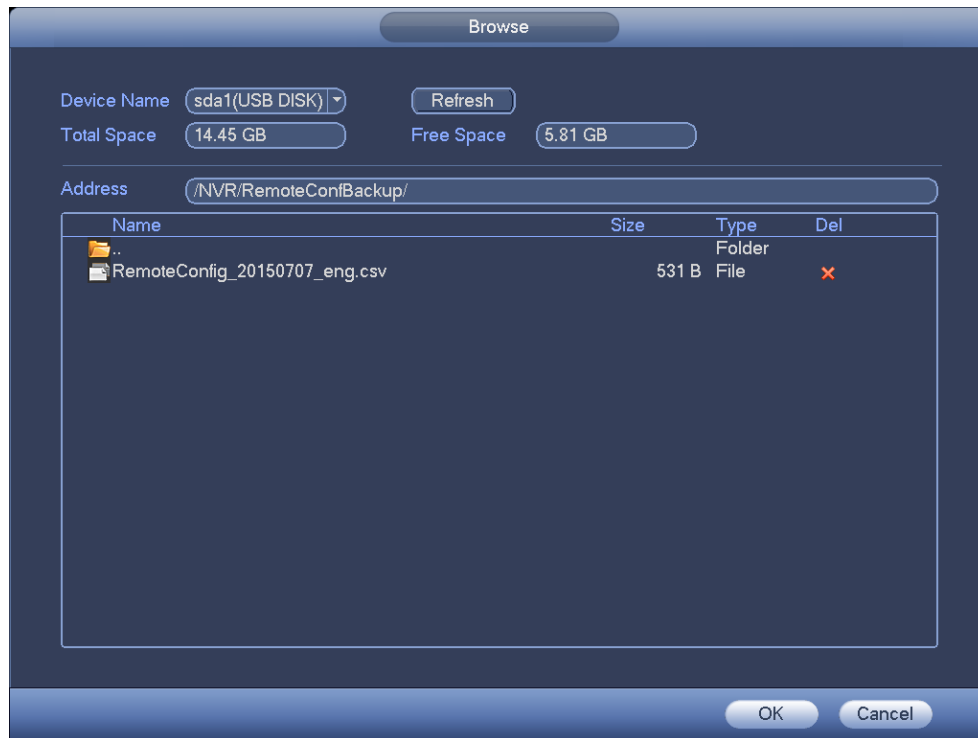

Figure 3-25

Select the import file and then click OK button.

#### Note

If the imported IP is already in the added device list, system pops up dialogue box for you to confirm overwrite or not.

- Click OK button, the new IP setup can overwrite the new one.
- Click Cancel button, system adds the new IP setup.



#### Important

- User may edit the exported file. Please make sure the file format is the same. Otherwise user may not import the file again!
- System does not support customized protocol import/export.
- The import/export function is for the devices of the same language.

### 3.5.2 Short-Cut Menu

In the preview interface, for the channel of no IPC connection, user may click the icon “+” in the centre of the interface to quickly go to the Remote Device interface. See Figure 3-26.

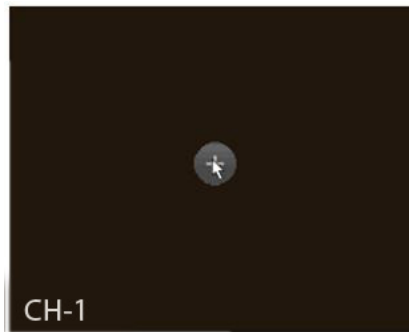

Figure 3-26

### 3.5.3 Image

From main menu->Setting->Camera->Image, user may see the image interface is shown as below. See Figure 3-27.

- Channel: Select a channel from the dropdown list.
- Config file: There are three configuration files. System sets proper parameters (such as brightness, contrastness and etc) for each configuration file. User may select according to your actual situation.
- Saturation: It is to adjust monitor window saturation. The value ranges from 0 to 100. The default value is 50. The larger the number, the strong the color is. This value has no effect on the general brightness of the whole video. The video color may become too strong if the value is too high. For the grey part of the video, the distortion may occur if the white balance is not accurate. Please note the video may not be attractive if the value is too low. The recommended value ranges from 40 to 60.
- Brightness: It is to adjust monitor window bright. The value ranges from 0 to 100. The default value is 50. The larger the number is, the bright the video is. When you input the value here, the bright

section and the dark section of the video will be adjusted accordingly. User may use this function when the whole video is too dark or too bright. Please note the video may become hazy if the value is too high. The recommended value ranges from 40 to 60.

- Contrast: It is to adjust monitor window contrast. The value ranges from 0 to 100. The default value is 50. The larger the number is, the higher the contrast is. User may use this function when the whole video bright is OK but the contrast is not proper. Please note the video may become hazy if the value is too low. If this value is too high, the dark section may lack brightness while the bright section may over exposure .The recommended value ranges from 40 to 60.
- Auto Iris: It is for the device of the auto lens. User may check the box before ON to enable this function. The auto iris may change if the light becomes different. When you disable this function, the iris is at the max. System does not add the auto iris function in the exposure control. This function is on by default.
- Gamma: It is to set each pixel brightness. The higher the value is, the brighter the image is. The value ranges from 0 to 100. The recommended value ranges from 40 to 60.
- Mirror: It is to switch video left and right limit. This function is disabled by default.
- Flip: Please select from the dropdown list. It includes normal/180°/90°/270° and etc. Some camera sports flip mode.
- 3D NR: It is to process multiple-frame (At least two frames). System uses the information between these two frames to realize noise reduction function.
- BLC: It includes several options: BLC/WDR/HLC/OFF.
- ✧ BLC: There are two modes: default/customize. For the default mode, the device auto exposures according to the environments situation so that the darkest area of the video is clearer. For the customized mode, user may select a rectangle zone to enhance its brightness to the proper level.
- ✧ WDR: For the WDR scene, this function can lower the high bright section and enhance the brightness of the low bright section. So that user may view these two sections clearly at the same time. The value ranges from 1 to 100. When you switch the camera from no-WDR mode to the WDR mode, system may lose several seconds record video.
- ✧ HLC: After you enabled HLC function, the device can lower the brightness of the brightest section according to the HLC control level. It can reduce the area of the halo and lower the brightness of the whole video.
- ✧ OFF: It is to disable the BLC function. Please note this function is disabled by default.
- Profile: It is to set the white balance mode. It has effect on the general hue of the video. This function is on by default. User may select the different scene mode such as auto, sunny, cloudy, home, office, night, disable and etc to adjust the video to the best quality.
- ✧ Auto: The auto white balance is on. System can auto compensate the color temperature to make sure the vide color is proper.
- ✧ Sunny: The threshold of the white balance is in the sunny mode.
- ✧ Night: The threshold of the white balance is in the night mode.
- ✧ Customized: User may set the gain of the red/blue channel. The value reneges from 0 to 100.
- W/B Mode: It is to set white balance mode. It can affect the video total hue. The default setup is auto. Please note different cameras support different modes. Please select from the dropdown list. The options include sunny/night/customized and etc.
- Day/night. It is to set device color and the B/W mode switch. The default setup is auto.
- ✧ Color: Device outputs the color video.
- ✧ Auto: Device auto select to output the color or the B/W video according to the device feature (The general bright of the video or there is IR light or not.)

- ✧ B/W: The device outputs the black and white video.
- ✧ Sensor: It is to set when there is peripheral connected IR light. **Please note some non-IR series product support sensor input function.**

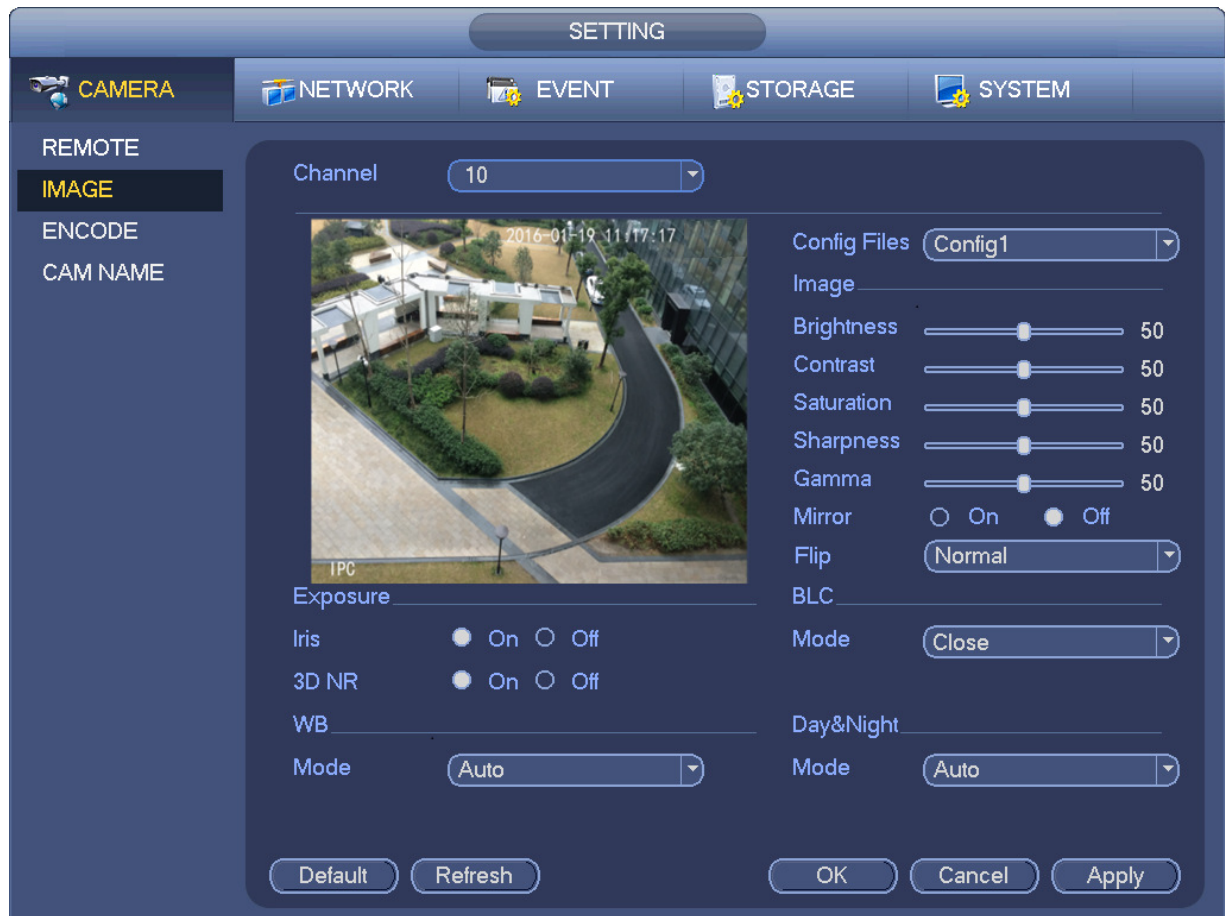

Figure 3-27

### 3.5.4 Channel Name

From main menu->Setting->Camera->Channel name, user may see an interface shown as in Figure 3-28.

It is to modify channel name. It max supports 31-character.

Please note user may only modify the channel name of the connected network camera.



Figure 3-28

### 3.5.5 Upgrade

#### Important

**System max supports to upgrade 8 network cameras at the same time.**

It is to update the network camera.

From main menu->Setting->Camera->Remote->Upgrade, the interface is shown as below. See Figure 3-29.

Click Browse button and then select the upgrade file. Then select a channel (or user may select device type filter to select several devices at the same time.)

Click Start upgrade button to upgrade. User may see the corresponding dialogue once the upgrade is finish.



Figure 3-29

### 3.6 Preview

After device booted up, the system is in multiple-channel display mode. See Figure 3-30. Please note the displayed window amount may vary. The following figure is for reference only. Please refer to chapter 1.3 Specifications for the window-amount your product supported.

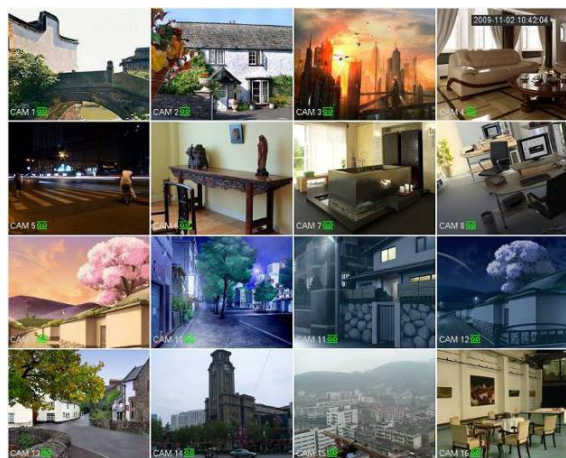







Figure 3-30

#### 3.6.1 Preview

If you want to change system date and time, user may refer to general settings (Main Menu->Setting->System->General). If you want to modify the channel name, please refer to the display settings (Main Menu->Camera->CAM name)

Please refer to the following sheet for detailed information.

1		Current channel pops up this icon when it is recording.	3		Current channel pops up this icon when video loss alarm occurs.
2		Current channel pops up this icon when motion detect alarm occurs.	4		Current channel pops up this icon when it is in monitor lock status.
5		System exceeds decoded channel amount.			

**Tips**

- Preview drag: If you want to change position of channel 1 and channel 2 when you are previewing, user may left click mouse in the channel 1 and then drag to channel 2, release mouse user may switch channel 1 and channel 2 positions.

**3.6.2 Preview Control Interface**

Move you mouse to the top centre of the video of current channel, user may see system pops up the preview control interface. See Figure 3-31. If your mouse stays in this area for more than 6 seconds and has no operation, the control bar automatically hides.



Figure 3-31



1) Instant playback

It is to playback the previous 5-60 minutes record of current channel.

Please go to the Main menu->Setting->->System->General to set real-time playback time. System may pop up a dialogue box if there is no such record in current channel.

2) Digital zoom

It is to zoom in specified zone of current channel. It supports zoom in function of multiple-channel.

Click button , the button is shown as .

There are two ways for you to zoom in.

- Drag the mouse to select a zone; user may view an interface show as Figure 3-32.



Figure 3-32

- Put the middle button at the centre of the zone you want to zoom in, and move the mouse, user may view an interface shown as in Figure 3-33.

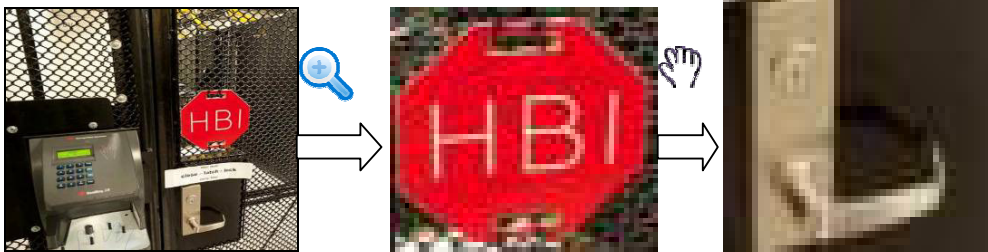



Figure 3-33

Right click mouse to cancel zoom and go back to the original interface.

### 3) Manual record function



It is to backup the video of current channel to the USB device. System can not backup the video of multiple-channel at the same time.



Click button , system begins recording. Click it again, system stops recording. User may find the record file on the flash disk.

### 4) Manual Snapshot

Click  to snapshot 1-5 times. The snapshot file is saved on the USB device or HDD. User may go to the Search interface (chapter 3.12) to view.

### 5) Bidirectional talk

If the connected front-end device supports bidirectional talk function, user may click this button. Click button  to start bidirectional talk function the icon now is shown as . Now the rest bidirectional talk buttons of digital channel becomes null too.

Click  again, user may cancel bidirectional talk and the bidirectional talk buttons of other digital channels become as .

### 6) Switch stream

Click , user may switch between the main stream and the sub stream.

M: M stands for main stream.

S: S stands for sub stream. System supports 3 sub streams (S1/S2/S3). Please refer to chapter 3.11.1.1.

## 3.6.3 Right Click Menu

After you logged in the device, right click mouse, user may see the short cut menu. Please see Figure 3-34.

- Window split mode: User may select window amount and then select channels.
- Custom split: It is to set video split mode and displayed channel.
- PTZ: Click it to go to PTZ interface. Please refer to chapter 3.8.
- Fish eye: It is to set fish eye installation mode and display mode. Please refer to chapter 3.7.



- Split track: It is to set the video to be displayed at the same screen as 4/6-window mode. Please refer to chapter 3.7.
- Smart Track: It is to view the trigger video of the fish eye and PTZ camera. Please refer to chapter 3.7.

Auto focus: It is to set auto focus function. Please make sure the connected network camera supports this function.

- Image: Set video corresponding information. Please refer to chapter 3.5.3.
- Search: Click it to go to Search interface to search and playback a record file. Please refer to chapter 3.12.
- Record control: Enable/disable record channel and alarm control. Please refer to chapter 3.11 and 3.14.10 .
- Remote: Search and add a remote device. Please refer to chapter 3.5.
- Main menu: Go to system main menu interface.

**Tips:**

Right click mouse to go back to the previous interface.



Figure 3-34

### 3.6.4 Preview Display Effect Setup

#### 3.6.4.1 Display

From Main Menu->Setting->System->Display, user may go to the following interface. See Figure 3-35. Here user may set menu and video preview effect. All you operation here does not affect the record file and playback effect.

Now user may set corresponding information.

- Time display: User may select to display time or not when system is playback.

- Channel display: User may select to channel name or not when system is playback.
- Image enhance: Check the box; user may optimize the margin of the preview video.
- IVS rule: Check the box to enable IVS function. System can display IVS rule on the preview video.
- Original scale: User may set different original rates for different channels. Click Set and then select a channel, user may restore original rate.
- Screen mode: It is for dual-screen operation. Please select from the dropdown list according to your actual situation. Click Apply button, system needs to restart to activate new setup. For example, 32+4 means for VGA, system max supports 32-window split and for HDMI2, system max supports 4-window split. Please note this function is for some series product only.
- Screen enable: Check the box here to enable the screen. In this way, it can display the video.
- Screen No. Select the corresponding screen from the dropdown list and then set resolution.
- Resolution: There are four options: 1920×1080, 1280×1024, 1280×720, and 1024×768. The VGA default resolution is 1280×1024; HDMI default resolution is 1920×1080. Please note the system needs to reboot to activate current setup.



Figure 3-35

- Preview mode: It is to set preview display mode. Please select from the dropdown list.
- ◇ General: There is no displayed information on the preview interface.
- ◇ Human face: System will display human face information on the right pane of the preview interface. See Figure 3-36.

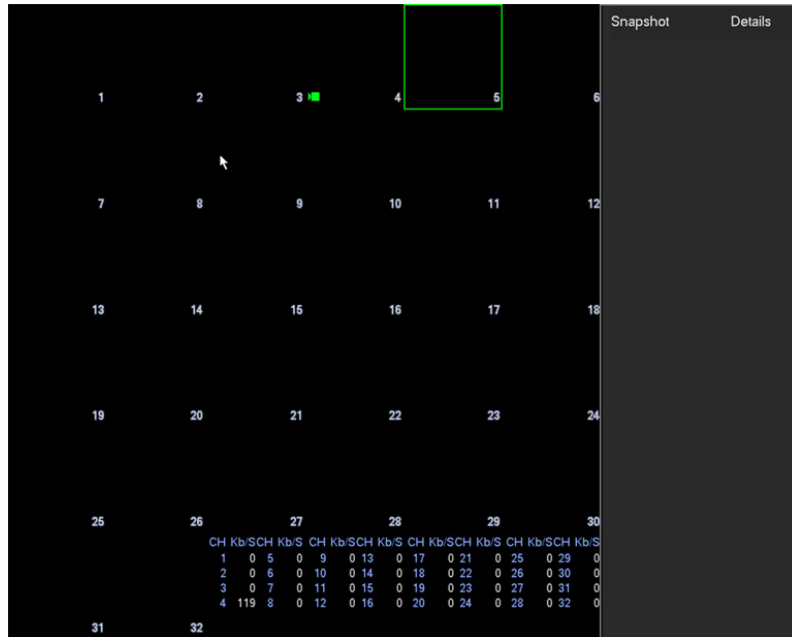

Figure 3-36

- POS info: Check the box, system will display POS information on the preview interface. Click OK button to save current setup.

### 3.6.4.2 Preview Tour Parameters

Set preview display mode, channel display sequence and tour setup.

- Set preview display mode: On the preview interface, right click mouse, user may view right-click menu. Now user may select preview window amount and channel.
- Set channel display mode: On the preview interface, if you want to change channel 1 and channel 16 position, please right click channel 1 video window and then drag to the channel 16 video window, release button, user may change channel 1 and channel 16 position.
- Tour setup: Here user may set preview window channel display mode and interval. Please follow the steps listed below.

From Main menu->Setting->System->Display->Tour, user may see an interface shown as in Figure 3-37. Here user may set tour parameter.

- Screen No.: Please select screen from the dropdown list.
- Video detect: It is to set video detect tour. System supports 1/8-window tour.
- Alarm: It is to set alarm tour. System supports 1/8-window tour.
- Enable tour: Check the box here to enable tour function.
- Interval: Input proper interval value here. The value ranges from 1-120 seconds.
- Window split: It is to set window split mode.



Figure 3-37

**Tips**

On the navigation bar, click   to enable/disable tour.  
 Click Save button to save current setup.

**3.6.4.3 Custom Split**

It is to set customized local preview display mode.

From Main menu->Setting->System->Display->Custom split, user may see an interface shown as in Figure 3-38.

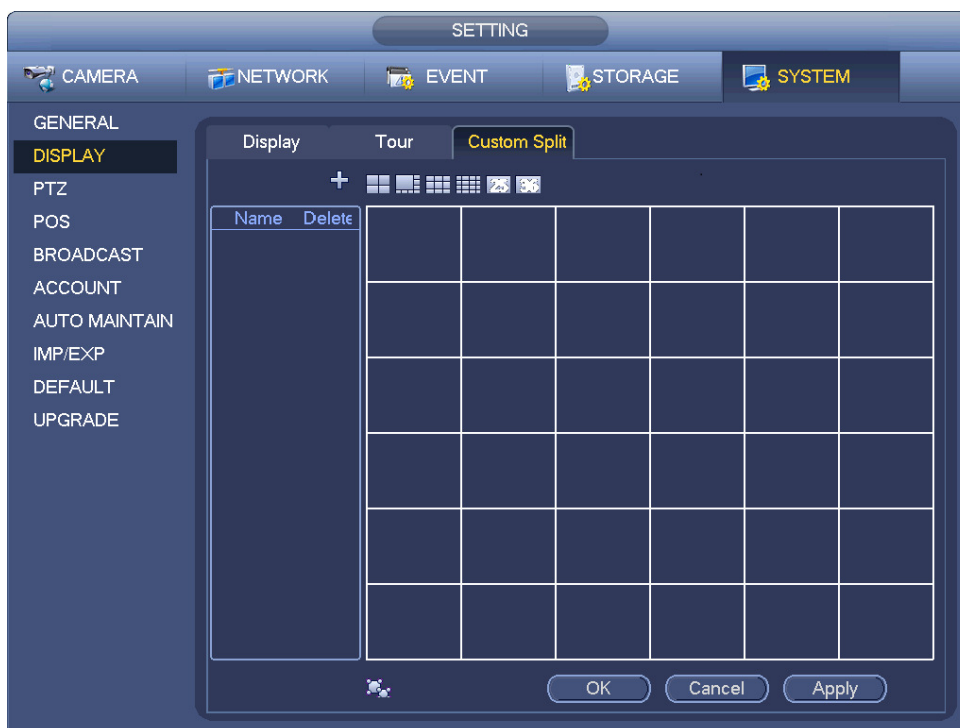

Figure 3-38

Click  and then click  to select basic mode

In regular mode, drag the mouse in the preview frame, user may merge several small windows to one window so that user may get you desired split mode.

After the setup, the selected window has the red frame. See Figure 3-39.

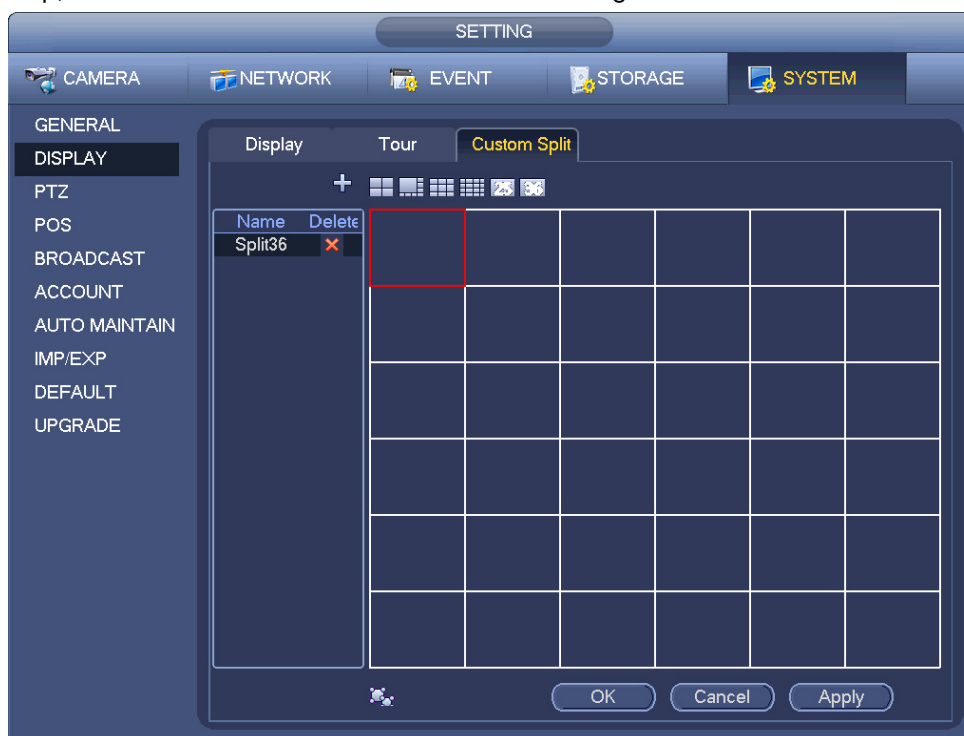



Figure 3-39

Select the merging window, the frame is red; user may click  to cancel the merge to restore regular mode.

Click Save to exit.

After the setup, user may go to the preview window, right click mouse and then select custom split. See Figure 3-40.

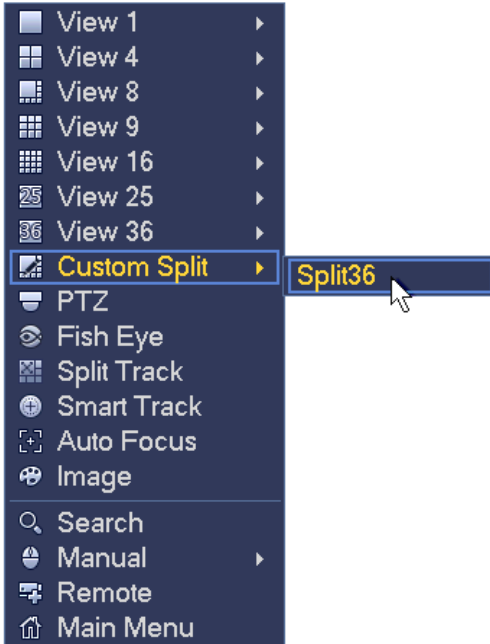

Figure 3-40

## 3.7 Fish Eye

### 3.7.1 Fish eye de-warp during preview interface

On the preview interface, select fisheye channel and then right click mouse, user may select fisheye. Now user may see an interface shown as in Figure 3-41. User may set fisheye installation mode and display mode.

**Note:**

- For the non-fisheye channel, system pops up dialogue box to remind you it is not a fisheye channel and does not support de-warp function.
- If system resources are insufficient, system pops up the corresponding dialogue box too.

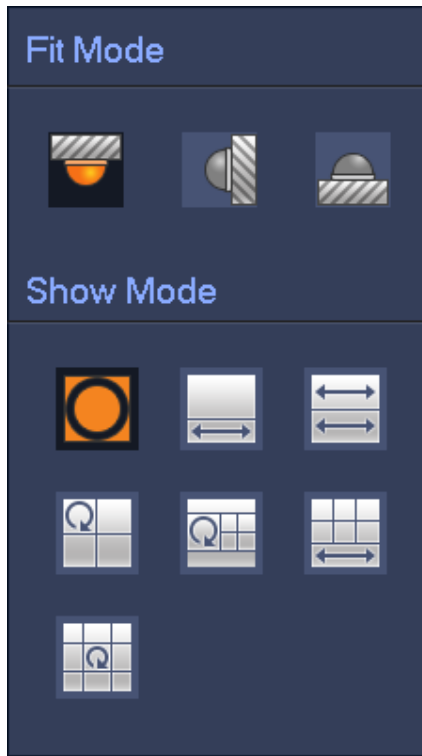

















Figure 3-41

There are three installation modes: ceiling mount/wall mount/ground mount. The different installations modes have different de-warp modes.

Please refer to the following sheet for detailed information.

Installation modes	Icon	Note
 (Ceiling mount)  (Ground mount)		360°panorama original view
		1 de-warp window+1 panorama stretching
		2 panorama stretching view
		1 360° panorama view+3 de-warp windows
		1 360°panorama view+4 de-warp windows
		4 de-warp windows+1 panorama stretching
		1 360° panorama view+8 de-warp windows
 (Wall mount)		360°panorama original view
		Panorama stretching

	1 panorama unfolding view+3 de-warp windows
	1 panorama unfolding view +4 de warp windows
	1 panorama unfolding view +8 de warp windows

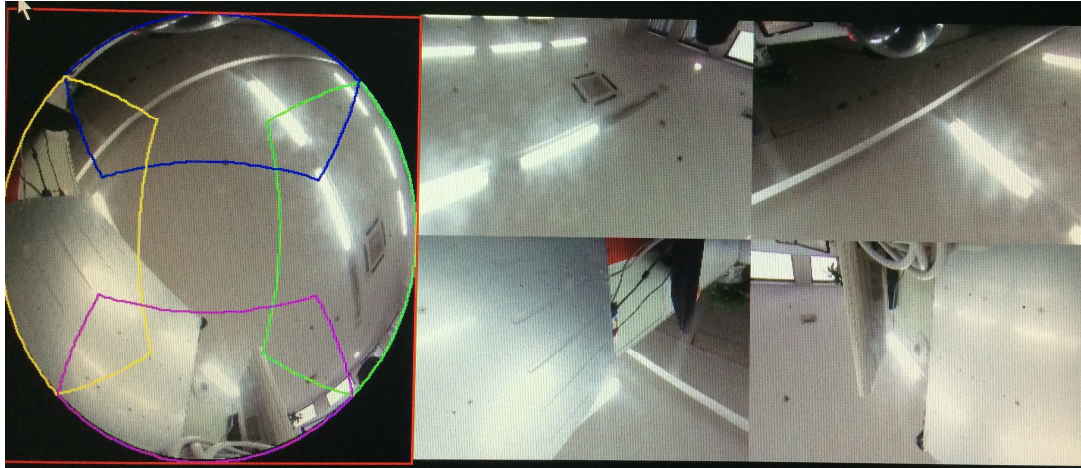



Figure 3-42

In Figure 3-42, user may adjust the color pane on the left pane or use your mouse to change the position of the small images on the right pane to realize fisheye de-warp. Please use the mouse to zoom in/zoom out, move/rotate the image. (Please note this function is not for wall mount mode)

### 3.7.2 Fish eye de-warp during playback

On the main menu, click search button.

Select 1-window playback mode and corresponding fisheye channel, click  to play.

Right click the , user may go to the de-warp playback interface. For detailed information, please refer to chapter 3.7.1.

## 3.8 Split Track

It is to display one video channel in several windows.

On the preview interface, right click mouse and then select split track, user may see an interface shown as below. See Figure 3-43.



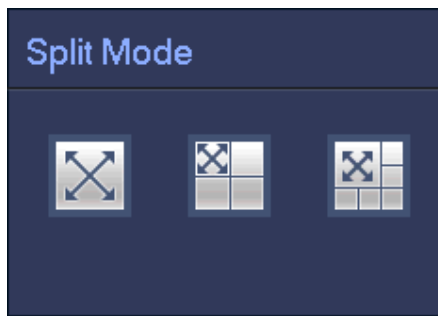

Figure 3-43

Please select split mode, it includes main screen, one main screen+3 extension screens, one main screen +5 extension screens. See Figure 3-44.

This function can divide the main screen to several windows. Use the mouse to adjust the frames in different colors to set the images to be displayed in the extension screen.

On the main screen or the extension screen, use the middle button of the mouse to zoom in or zoom out.

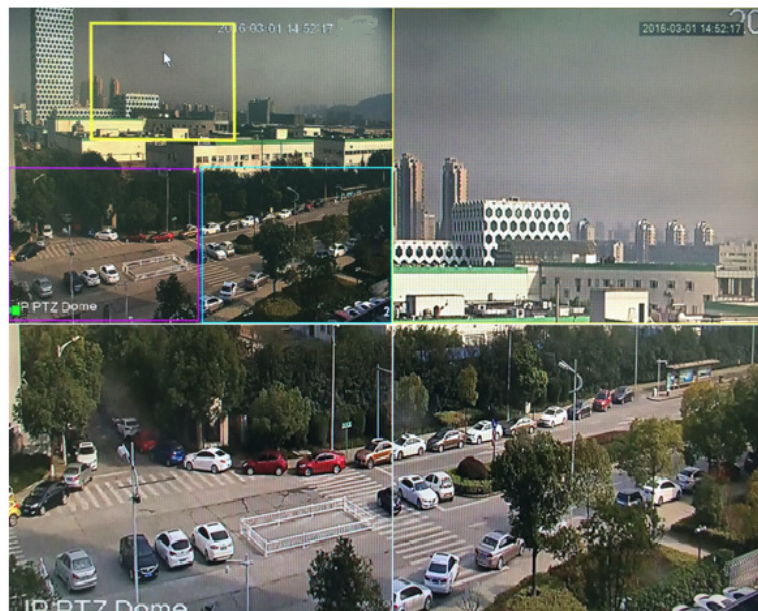

Figure 3-44

### 3.9 Smart Track

This function allows you to view the trigger video of the fish eye&PTZ camera. The fish eye is the main camera to view the whole surveillance condition, the PTZ camera works as the slave camera to view the details.

On the preview interface, select the corresponding window, right click mouse and then select Smart track, user may see an interface shown as below. See Figure 3-45.

**Note**

Please refer to chapter 3.14.8 for setup information.



Figure 3-45

## 3.10 PTZ

### Note:

**Before you control the PTZ, please make sure the PTZ decoder and the NVR network connection is OK and the corresponding settings are right.**

### 3.10.1 PTZ Settings

#### Cable Connection

Please follow the procedures below to go on cable connection

- Connect the dome RS485 port to NVR RS485 port.
- Connect dome video output cable to NVR video input port.
- Connect power adapter to the dome.

In the main menu, from Setting->System->PTZ, user may see an interface is shown as in Figure 3-46.

Here user may set the following items:

- Channel: Select the current camera channel.
- PTZ type: There are two types: local/remote. Please select local mode if you are connect RS485 cable to connect to the Speed dome (PTZ). Please select remote mode if you are connecting to the network PTZ camera.
- Protocol: Select corresponding PTZ protocol(such as PELCOD)
- Address: Default address is 1.
- Baud rate: Select corresponding baud rate. Default value is 9600. **USE 2400 FOR PELCO D**
- Data bit: Select corresponding data bits. Default value is 8.
- Stop bit: Select corresponding stop bits. Default value is 1.
- Parity: There are three options: odd/even/none. Default setup is none.



Figure 3-46

If you are connecting to network PTZ, the PTZ type shall be remote. See Figure 3-47.

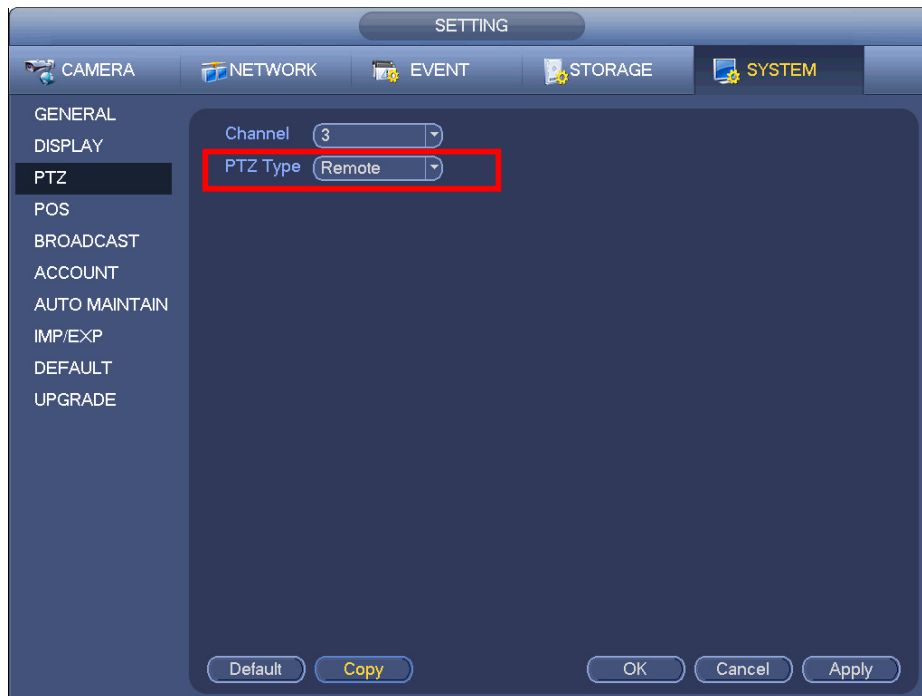

Figure 3-47

### 3.10.2 PTZ Control

After completing all the setting please click save button. Right click mouse (click “Fn” Button in the front panel or click “Fn” key in the remote control). The interface is shown as in Figure 3-48. Please note user may only go to the PTZ control interface when you are in 1-window display mode.

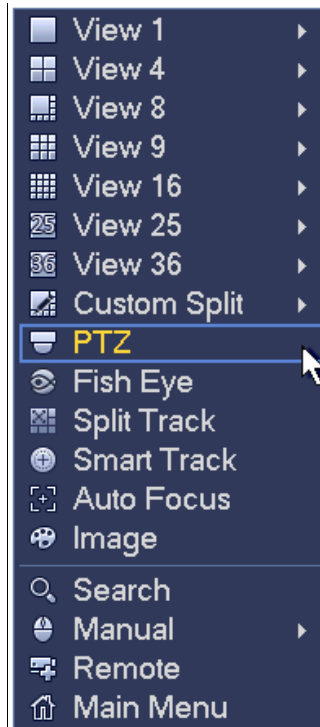

Figure 3-48



The PTZ setup is shown as in See Figure 3-49.

Please note the commend name is grey once device does not support this function.

The PTZ operation is only valid in one-window mode.

Here user may control PTZ direction, speed, zoom, focus, iris, preset, tour, scan, pattern aux function, light and wiper, rotation and etc.

Speed is to control PTZ movement speed. The value ranges from 1 to 8. The speed 8 is faster than speed 1. User may use the remote control to click the small keyboard to set.

User may click  and  of the zoom, focus and iris to zoom in/out, definition and brightness.

The PTZ rotation supports 8 directions. If you are using direction buttons on the front panel, there are only four directions: up/down/left/right.

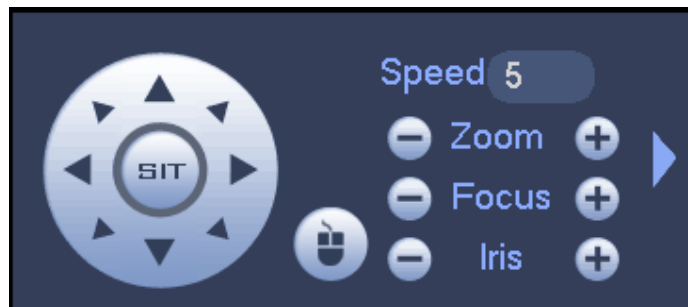

Figure 3-49

In the middle of the eight direction arrows, there is a 3D intelligent positioning key. See Figure 3-50.

Please make sure your protocol supports this function and you need to use mouse to control.

Click this key, system goes back to the single screen mode. Drag the mouse in the screen to adjust

section size. The dragged zone supports 4X to 16X speeds. It can realize PTZ automatically. The smaller zone you dragged, the higher the speed.



Figure 3-50

Name	Function key	function	Shortcut key	Function key	function	Shortcut key
Zoom		Near			Far	
Focus		Near			Far	
Iris		close			Open	

In Figure 3-49, click to open the menu, user may set preset, tour, pattern, scan and etc. See Figure 3-51.



Figure 3-51

Please refer to the following sheet for detailed information.

Please note the above interface may vary due to different protocols. The button is grey and can not be selected once the current function is null.

Right click mouse or click the ESC button at the front panel to go back to the Figure 3-49.

Icon	Function	Icon	Function
	Preset		Flip
	Tour		Reset
	Pattern		Aux
	Scan		Aux on-off button
	Rotate		Go to menu

### 3.10.2.1 PTZ Function Setup



Click , user may go to the following interface to set preset, tour, pattern, and scan. See Figure 3-52.



Figure 3-52

#### **Preset Setup**

In Figure 3-52, click preset button and use eight direction arrows to adjust camera to the proper position. The interface is shown as in Figure 3-53.

Click Set button and then input preset number.

Click Set button to save current preset.



Figure 3-53

#### **Tour Setup**

In Figure 3-52, click tour button.

Input tour value and preset No. Click Add preset button to add current preset to the tour. See Figure 3-54.

#### **Tips**

Repeat the above steps to add more presets to the tour. Click Del preset button to remove it from the tour.

Please note some protocols do not support delete preset function.



Figure 3-54

**Pattern Setup**

In Figure 3-52, click Pattern button and input pattern number.

Click Begin button to start direction operation. Or user may go back to Figure 3-49 to operate zoom/focus/iris/direction operation.

In Figure 3-52, click End button.



Figure 3-55

**Scan Setup**

In Figure 3-52, click Scan button.

Use direction buttons to set camera left limit and then click Left button.

Use direction buttons to set camera right limit and then click Right button. Now the scan setup process is complete.





Figure 3-56

### 3.10.2.2 Call PTZ Function

#### Call Preset

In Figure 3-51, input preset value and then click  to call a preset. Click  again to stop call.

#### Call Pattern

In Figure 3-51, input pattern value and then click  to call a pattern. Click  again to stop call.

#### Call Tour

In Figure 3-51, input tour value and then click  to call a tour. Click again  to stop call.

#### Call Scan

In Figure 3-51, input Scan value and then click  to call a tour. Click again  to stop call.

#### Rotate

In Figure 3-51, click  to enable the camera to rotate.  
System supports preset, tour, pattern, scan, rotate, light and etc function.

#### Note:

- Preset, tour and pattern all need the value to be the control parameters. User may define it as you require.
- You need to refer to your camera user's manual for Aux definition. In some cases, it can be used for special process.

#### Aux

Click , system goes to the following interface. The options here are defined by the protocol. The aux



number is corresponding to the aux on-off button of the decoder. See Figure 3-57.



Figure 3-57

## 3.11 Record and Snapshot

The record/snapshot priority is: Alarm->Motion detect->Schedule.

### 3.11.1 Encode

#### 3.11.1.1 Encode

Encode setting is to set IPC encode mode, resolution, bit stream type and etc.

From Main menu->Setting->System->Encode, user may see the following interface. See Figure 3-58.

- Channel: Select the channel you want.
- Type: Please select from the dropdown list. There are three options: regular/motion detect/alarm. User may set the various encode parameters for different record types.
- Compression: System supports H.264, MPEG4, MJPEG and etc.
- Resolution: The mainstream resolution type is IPC's encoding config. Generally there is D1/720P/1080P.
- Frame rate: It ranges from 1f/s to 25f/s in NTSC mode and 1f/s to 30f/s in PAL mode.
- Bit rate type: System supports two types: CBR and VBR. In VBR mode, user may set video quality.
- Video/audio: User may enable or disable the video/audio. Please note, once you enable audio function for one channel, system may enable audio function of the rest channels by default.
- Audio encode: Please select audio encode mode from the dropdown list. It includes: PCM/G711A/G711Mu/AAC.
- Audio sampling: It is the audio sampling rate in one second. The higher the sampling rate is, the more nature the audio is. There are two options: 8000(default)/16000.
- Copy: After you complete the setup, user may click Copy button to copy current setup to other channel(s). User may see an interface is shown as in Figure 3-65. User may see current channel number is grey. Please check the number to select the channel or user may check the box ALL. Please click the OK button in Figure 3-65 and Figure 3-59 respectively to complete the setup. Please note, once you check the All box, you set same encode setup for all channels. Audio/video enable box, overlay button and the copy button is shield.

Please highlight icon  to select the corresponding function.



Figure 3-58

### 3.11.1.2 Overlay

Click overlay button, user may see an interface is shown in Figure 3-59.

- Cover area: Here is for you to cover area section. User may drag you mouse to set proper section size. In one channel video, system max supports 4 zones in one channel. User may set with Fn button or direction buttons.
- Preview/monitor: The cover area has two types. Preview and Monitor. Preview means the privacy mask zone can not be viewed by user when system is in preview status. Monitor means the privacy mask zone can not be view by the user when system is in monitor status.
- Time display: User may select system displays time or not when you playback. Please click set button and then drag the title to the corresponding position in the screen.
- Channel display: User may select system displays channel number or not when you playback. Please click set button and then drag the title to the corresponding position in the screen.
- Customized title: System supports five customized titles.



Figure 3-59





### 3.11.2 Schedule

The record type priority is: Alarm>Motion detect>Regular.

#### 3.11.2.1 Schedule Record

Set record time, record plan and etc. Please note system is in 24-hour record by default after its first boot up.

In the main menu, from Main menu->Setting->Storage->Schedule, user may go to schedule menu. See Figure 3-63. There are total six periods.

- Channel: Please select the channel number first. User may select “all” if you want to set for the whole channels.
- ✧ : Sync connection icon. Select icon  of several dates, all checked items can be edited or together. Now the icon is shown as .
- ✧ : Click it to delete a record type from one period.
- Record Type: Please check the box to select corresponding record type. There are four types: Regular/MD (motion detect)/Alarm/MD&Alarm.
- Week day: There are eight options: ranges from Saturday to Sunday and all.
- Holiday: It is to set holiday setup. Please note you need to go to the General interface (Main Menu->Setting->System->General) to add holiday first. Otherwise user may not see this item.
- Pre-record: System can pre-record the video before the event occurs into the file. The value ranges from 1 to 30 seconds depending on the bit stream.

- Redundancy: System supports redundancy backup function. It allows you backup recorded file in two disks. User may highlight Redundancy button to activate this function. Please note, before enable this function, please set at least one HDD as redundant. (Main menu->Setting->Storage->HDD Manager). **Please note this function is null if there is only one HDD.**
- ANR: It is to save video to the SD card of the network camera in case the network connection fails. The value ranges from 0s~43200s. After the network connection resumed, the system can get the video from the SD card and there is no risk of record loss.
- Period setup: Click button  after one date or a holiday, user may see an interface shown as in Figure 3-64. There are five record types: regular, motion detection (MD), Alarm, MD & alarm, and intelligence.

Please following the steps listed below to draw the period manually.

- a) Select a channel you want to set. See Figure 3-60.



Figure 3-60

- b) Set record type. See Figure 3-61.



Figure 3-61

- c) Please draw manually to set record period. There are six periods in one day. See Figure 3-62.

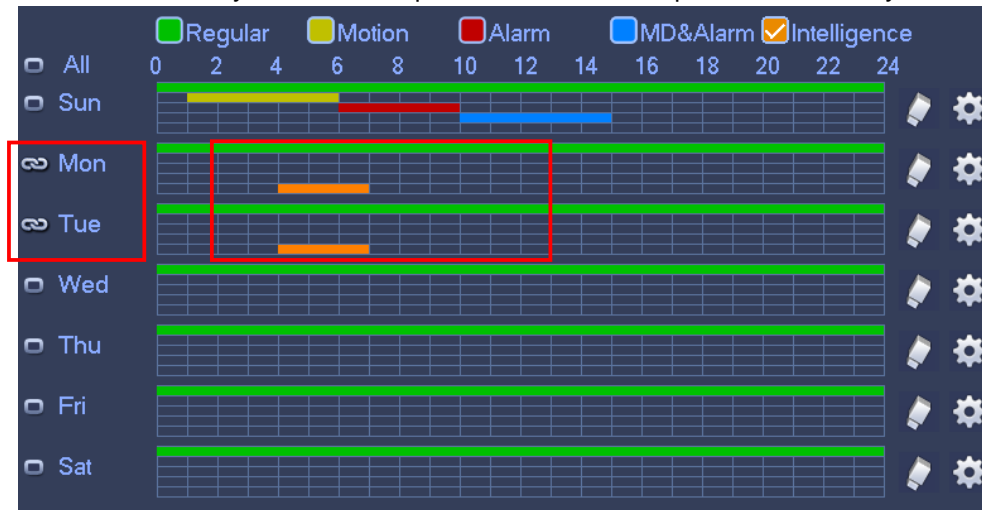

Figure 3-62

Please check the box  to select the corresponding function. After completing all the setups please click save button, system goes back to the previous menu.

There are color bars for your reference. Green color stands for regular recording, yellow color stands for motion detection and red color stands for alarm recording, and orange color stands for intelligent alarm. The white means the MD and alarm record is valid. Once you have set to record when the MD and alarm occurs, system will not record neither motion detect occurs nor the alarm occurs.

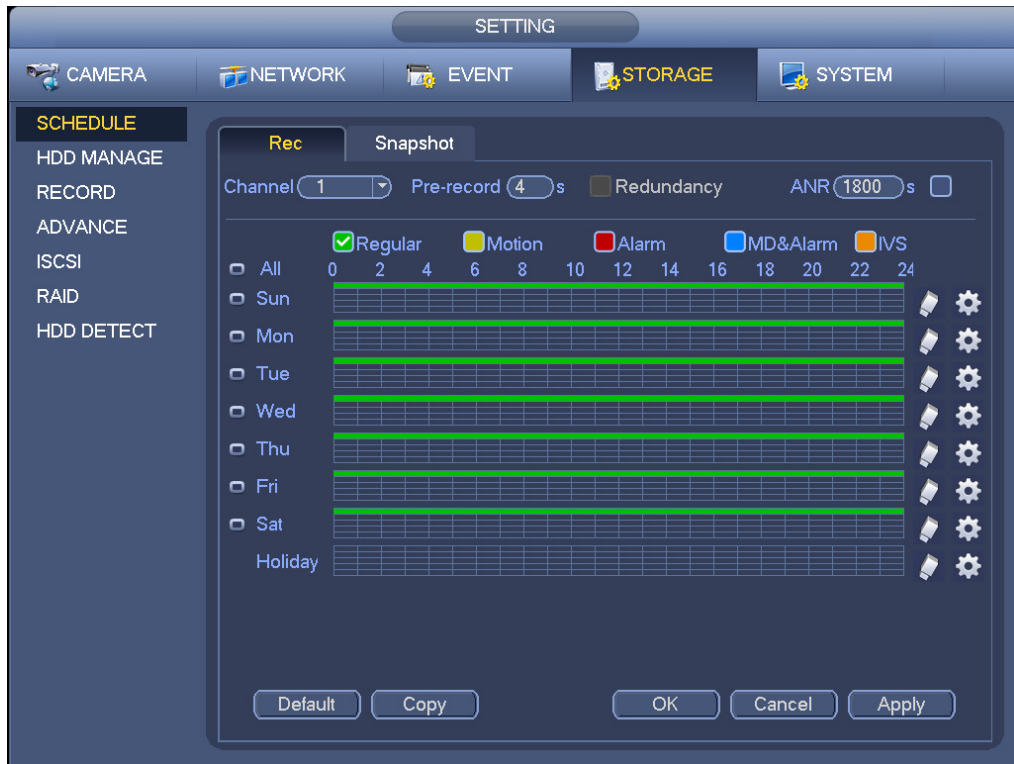

Figure 3-63



Figure 3-64

### Quick Setup

Copy function allows you to copy one channel setup to another. After setting in channel 1, click Copy button, user may go to interface Figure 3-65. User may see current channel name is grey such as channel 1. Now user may select the channel you want to paste such as channel 5/6/7. If you want to save current setup of channel 1 to all channels, user may click the first box "ALL". Click the OK button to save

current copy setup. Click the OK button in the Encode interface, the copy function succeeded. Please note, if you select ALL in Figure 3-65, the record setup of all channels are the same and the Copy button becomes hidden.

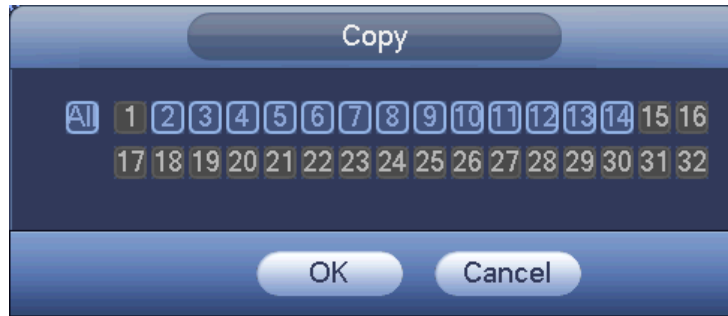

Figure 3-65

Click OK button to save current setup.

### 3.11.2.2 Schedule Snapshot

From Main menu->Setting->Storage->Record or on the preview interface, right click mouse and then select record item, user may see Figure 3-66.

Select snapshot channel and enable snapshot function. Click Save button.

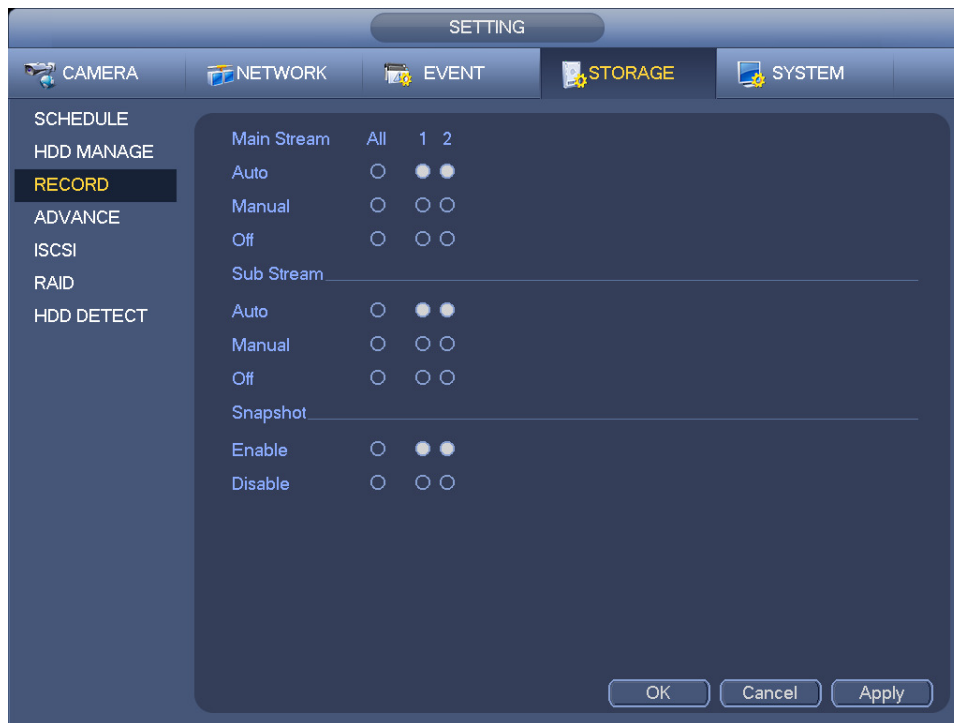

Figure 3-66

From Main menu->Setting->Camera->Encode->Snapshot, user may go to snapshot interface. See Figure 3-67.

Select the snapshot channel from the dropdown list and then select snapshot mode as Timing (Schedule) from the dropdown list and then set picture size, quality and snapshot frequency.



Figure 3-67

In the main menu, from Main menu->Setting->Storage->Schedule->Snapshot, user may go to schedule menu. See Figure 3-63. Here user may set snapshot period. There are total six periods in one day. Please refer to chapter 3.11.2.1 for detailed setup information. The setup steps are general the same.



Figure 3-68

## Note

- Please note the trigger snapshot has the higher priority than regular snapshot. If you have enabled these two types at the same time, system can activate the trigger snapshot when an alarm occurs, and otherwise system just operates the regular snapshot.
- Only the trigger snapshot supports this function. The regular snapshot function can not send out picture via the email. But user may upload the picture to a FTP.

### 3.11.3 Motion Detect Record/Snapshot

#### 3.11.3.1 Motion detect record

- a) From Main menu->Setting->Event->Video detect, user may go to the following interface. See Figure 3-69.



Figure 3-69



- b) Select a channel from the dropdown list and then check the enable button to enable motion detect function.
- c) Click Region Click select button, the interface is shown as in Figure 3-70. Here user may set motion detection zone. There are four zones for you to set. Please select a zone first and then left drag the mouse to select a zone. The corresponding color zone displays different detection zone. User may click Fn button to switch between the arm mode and disarm mode. In arm mode, user may click the direction buttons to move the green rectangle to set the motion detection zone. After you completed the setup, please click ENTER button to exit current setup. Do remember click save button to save current setup. If you click ESC button to exit the region setup interface system will not save your zone setup.





Figure 3-70

d) Period: Click set button, user may see an interface is shown as in Figure 3-71. Here user may set motion detect period. System only enables motion detect operation in the specified periods. It is not for video loss or the tampering. There are two ways for you to set periods. Please note system only supports 6 periods in one day.

✧ In Figure 3-71, Select icon  of several dates, all checked items can be edited together. Now the icon is shown as . Click  to delete a record type from one period.

✧ In Figure 3-71. Click button  after one date or a holiday, user may see an interface shown as in Figure 3-72. There are four record types: regular, motion detection (MD), Alarm, MD & alarm.

e) Set sensitivity. Please note the sixth level has the highest sensitivity.

f) Click Save button to complete motion detect setup.

g) From Main menu->Setting->Storage->Schedule. See Figure 3-63.

h) Set motion detect record channel, period and the record type shall be motion detect (MD). Please refer to chapter 3.11.2.

i) Click Copy button to copy current setup to other channel(s).

j) Click OK button to complete motion detect record setup.

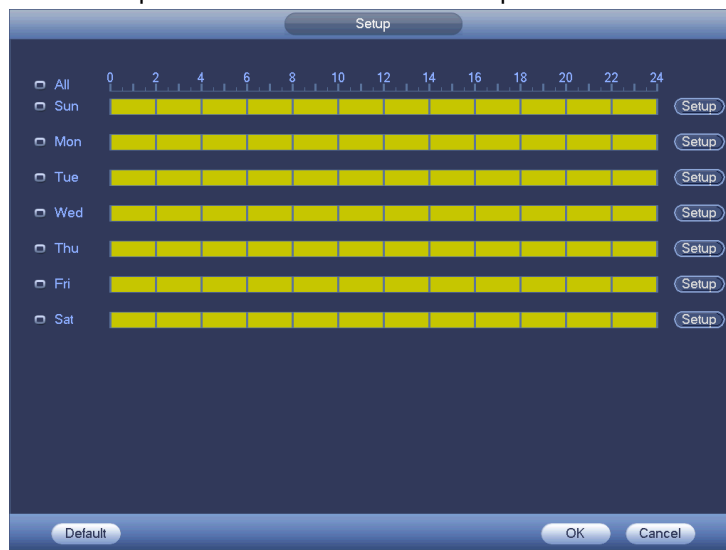

Figure 3-71



Figure 3-72

### 3.11.3.2 Motion Detect Snapshot

- From Main menu->Setting->Camera->Encode->Snapshot, user may go to snapshot interface. See Figure 3-73.
- In Figure 3-73, select trigger snapshot from the dropdown list and then set picture size, quality and snapshot frequency. Click OK button to save current setup.
- From Main menu->Setting->Event->Detect, here user may select motion detect type, motion detect channel and then check the enable box. Please refer to chapter 3.11.3.1.
- Click OK button to complete motion detect setup.



Figure 3-73

### 3.11.4 Alarm Record/Snapshot

#### 3.11.4.1 Alarm Record

- a) Before you set alarm setup information, please go to chapter 2.3 to connect alarm input and alarm output cable (such as light, siren and etc).
- b) The record priority is: Alarm>Motion detect>Regular.

In the main menu, from Setting->Event-> Alarm, user may see alarm setup interface. See Figure 3-74.

- Alarm in: Here is for you to select channel number.
  - Event type: There are four types. Local input/network input/IPC external/IPC offline alarm.
    - ◇ Local alarm: The alarm signal system detects from the alarm input port.
    - ◇ Network alarm: It is the alarm signal from the network.
    - ◇ IPC external alarm: It is the on-off alarm signal from the front-end device and can activate the local NVR.
    - ◇ IPC offline alarm: Once you select this item, system can generate an alarm when the front-end IPC disconnects with the local NVR. The alarm can activate record, PTZ, snapshot and etc. The alarm can last until the IPC and the NVR connection resumes.
  - Enable: Please you need to highlight this button to enable current function.
  - Type: normal open or normal close.
- c) Click Save button to complete alarm setup interface.

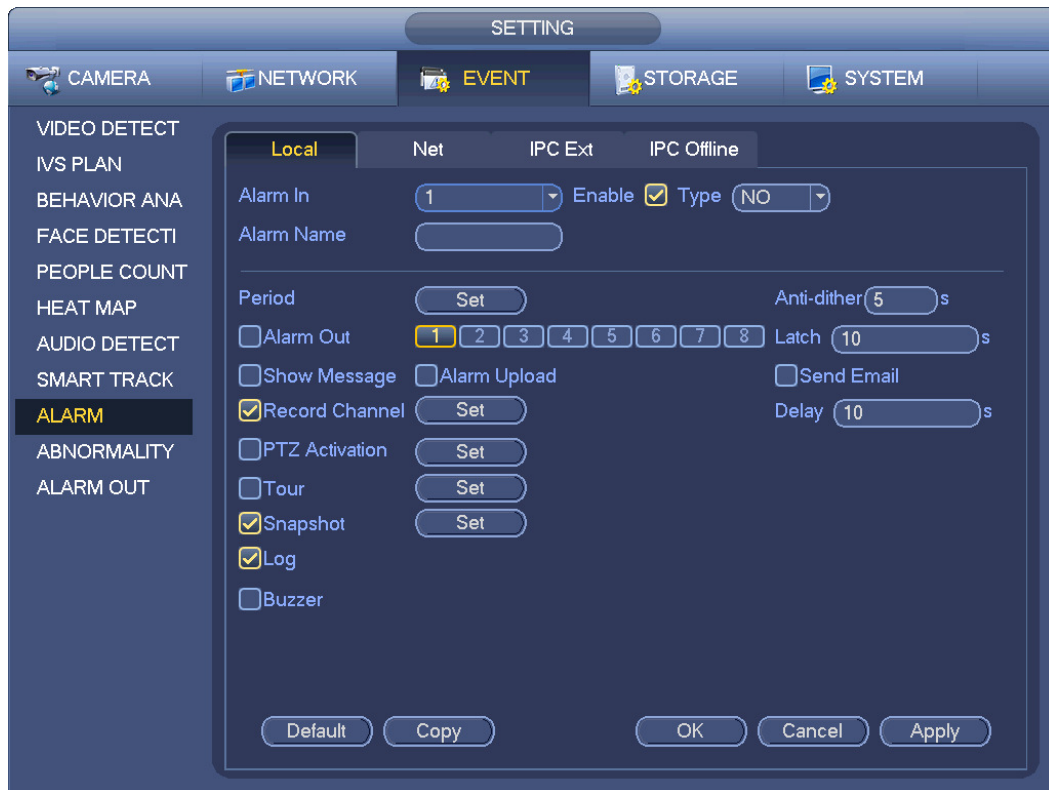

Figure 3-74

- d) From Main menu->Setting->Storage->Schedule, user may go to Figure 3-63.
- e) Select alarm channel, period and the record type shall be alarm. Please refer to chapter 3.11.2.
- f) Click Copy button to copy current setup to other channel(s).
- g) Click OK button to save alarm record information.

### 3.11.4.2 Alarm Snapshot

- a) Please refer to Step a) to step c) of chapter 3.11.3.2 to enable timing snapshot.
- b) From Main menu->Setting->Storage->schedule, user may go to Figure 3-75 to enable snapshot function.
- c) From Main menu->Setting->Event->Alarm, user may go to Figure 3-74 to set alarm parameter and enable snapshot function.
- d) Click Save button to save alarm snapshot setup.



Figure 3-75

### 3.11.5 Manual Record/Snapshot

You need to have proper rights to implement the following operations. Please make sure the HDD has been properly installed.

#### 3.11.5.1 Manual Record

- a) Right click mouse and select manual record or in the main menu, from Setting->Storage->Manual Record. Manual record menu is shown as in Figure 3-76.

#### **Tips**

User may click Rec button on the front panel (if possible) to go to the Manual Record interface.

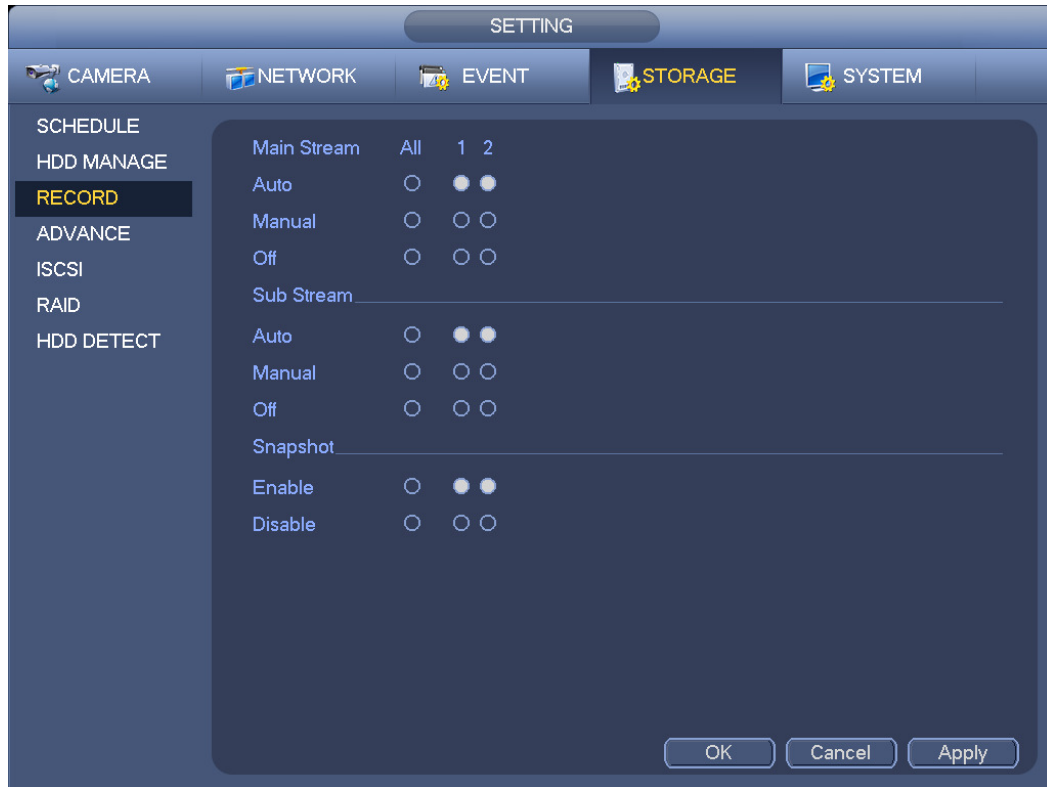



Figure 3-76

b) Check the box here to select manual record channel(s). User may see the corresponding indicator light on the front panel is on.

- Channel: It is to display device all channels.
- Manual: It has the highest priority. Enable corresponding channel to record no matter what period applied in the record setup. Now system is record general file.
- Auto: System enables auto record function as you set in chapter 3.11.2 schedule interface (General/Motion detect/Alarm)
- Stop: Stop current channel record/Snapshot no matter what period applied in the record setup.
- All: Check the All box to select all channels.

c) Click OK button to complete manual record setup.

### 3.11.5.2 Manual Snapshot

Click  button at the preview control bar, user may snapshot 1-5 picture(s). From main menu->Setting->Camera->Encode->Snapshot, user may set snapshot times. User may go to chapter 3.12 to view snapshot picture.

## 3.11.6 Holiday Record/Snapshot

It is for you to set holiday record or snapshot plan. Please note the holiday record/snapshot setup has the higher priority than the ordinary date record/snapshot setup.

### 3.11.6.1 Holiday Record

a) From Mani menu->Setting->System->General, user may go to the following interface. See

Figure 3-77.

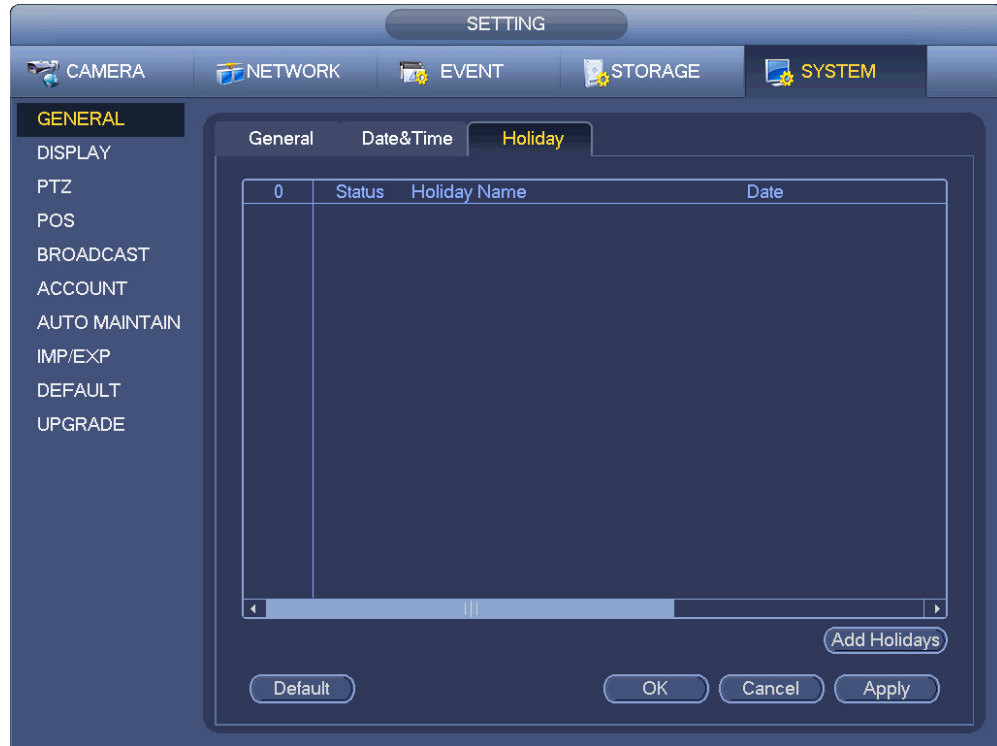

Figure 3-77

- b) Click Add new holiday button, user may see an interface shown as in Figure 3-78. Here user may set holiday date name, repeat mode, start time/end time and etc.



Figure 3-78

- c) Click Add button to complete holiday setup. Now user may enable holiday setup and then click

Apply button.

- d) From Main menu->setting->Storage->schedule, user may go to schedule interface. See Figure 3-79. Now user may set period and record type of holiday time. Please refer to chapter 3.11.2.1 for detailed setup information.

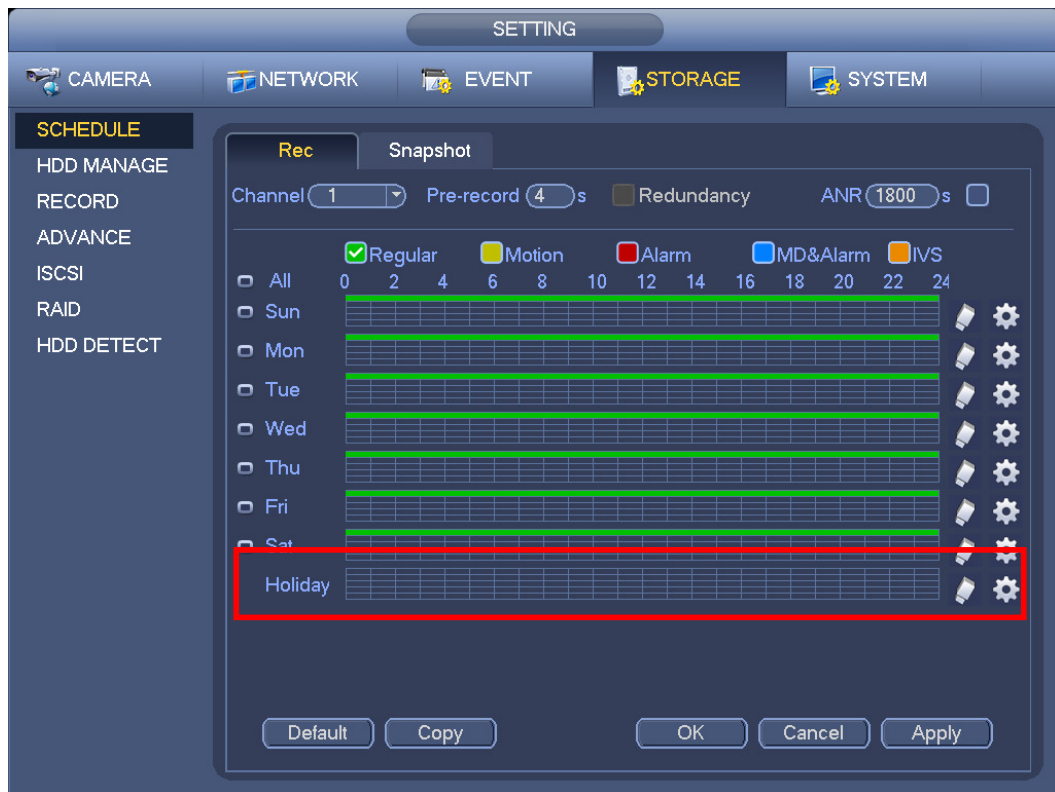

Figure 3-79

- e) Click OK button to set holiday record setup.

### 3.11.6.2 Holiday Snapshot

Set Holiday date first. Please refer to step a) to step c) of chapter 3.11.6.1.

From Main menu->Setting->Storage->Schedule, user may go to schedule interface. See Figure 3-79. Click Holiday item to set snapshot period.

Set holiday snapshot type (Trigger/Regular). Please refer to chapter 3.11.2.2 or chapter 3.11.3.2.

## 3.11.7 Other Record/Snapshot

Motion detect&Alarm record or snapshot, please refer to chapter 3.11.4.

Video loss or tampering record or snapshot function, please refer to chapter 3.11.3.

## 3.12 Search and Playback

### 3.12.1 Real-time Playback

Please refer to chapter 3.6.2 for real-time playback information.

### 3.12.2 Search Interface

From Main menu->Search, or on the preview interface right click mouse and then select search item; user

may go to the following interface. See Figure 3-80.

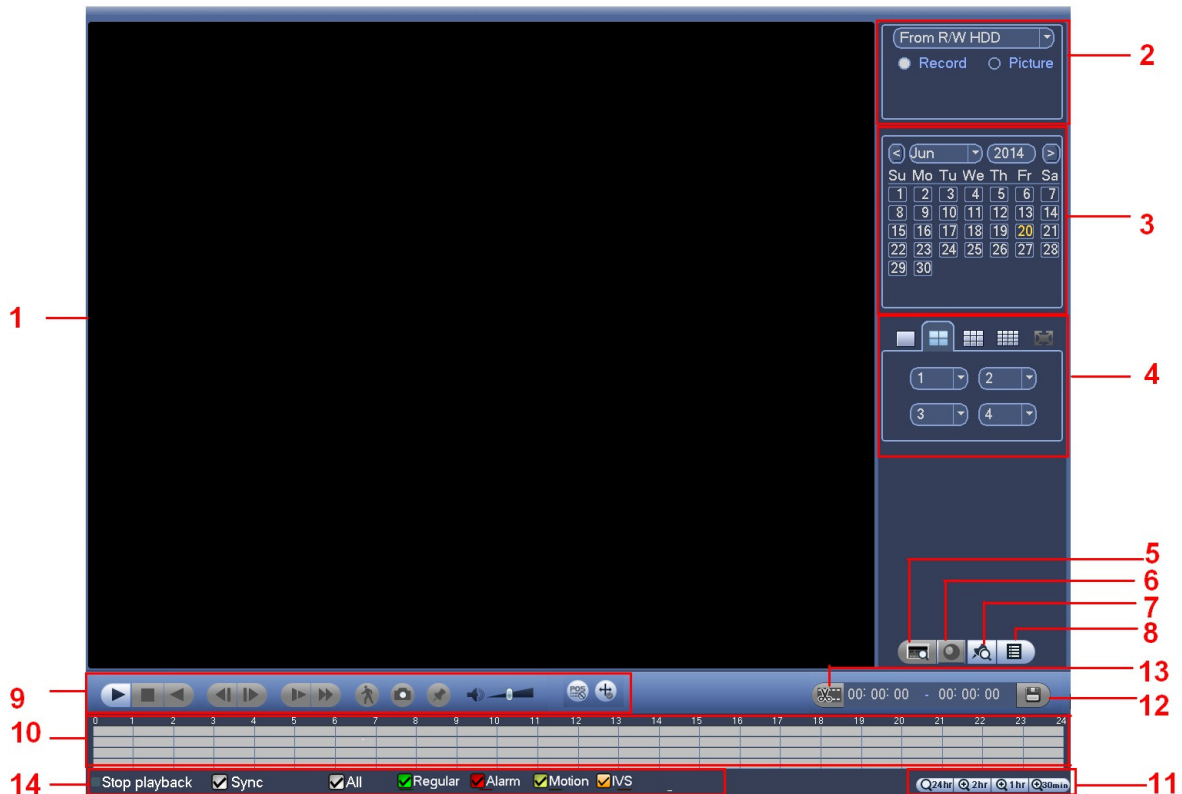
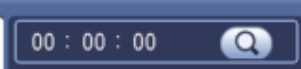















Figure 3-80

Please refer to the following sheet for more information.

SN	Name	Function
1	Display window	<ul style="list-style-type: none"> <li>● Here is to display the searched picture or file.</li> <li>● Support 1/4/9/16-window playback.</li> </ul>
2	Search type	<ul style="list-style-type: none"> <li>● Here user may select to search the picture or the recorded file.</li> <li>● User may select to play from the read-write HDD, from peripheral device or from redundancy HDD.</li> <li>● Before you select to play from the peripheral device, please connect the corresponding peripheral device. User may view all record files of the root directory of the peripheral device. Click the Browse button; user may select the file you want to play.</li> </ul>
3	Calendar	<ul style="list-style-type: none"> <li>● The blue highlighted date means there is picture or file. Otherwise, there is no picture or file.</li> <li>● In any play mode, click the date you want to see, user may see the corresponding record file trace in the time bar.</li> </ul>
4	Playback mode and channel selection pane.	<ul style="list-style-type: none"> <li>● Playback mode: 1/4/9/16. (It may vary due to different series.)</li> <li>◇ In 1-window playback mode: user may select 1-X channels (X depends on the product channel amount).</li> <li>◇ In 4-window playback mode: user may select 4 channels according to your requirement.</li> <li>◇ In 9-window playback mode, user may switch between 1-8, 9-16 and etc</li> </ul>



		<p>channels.</p> <ul style="list-style-type: none"> <li>◇ In 16-window playback mode, user may switch between 1-16, 17-32 and etc channels.</li> <li>● The time bar will change once you modify the playback mode or the channel option.</li> </ul>
5	POS search	In 1-channel playback mode, click it user may set advanced setup.
6	Fisheye dewarp	In 1-channel playback mode, click it; user may see fisheye setup interface on the right pane. User may set fisheye installation mode and display mode to de-warp the record. Please refer to chapter 3.7.2 for detailed information.
7	Mark file list button	Click it to go to mark file list interface. User may view all mark information of current channel by time. Please refer to chapter 3.12.5 for detailed information. Please note only the product of this icon supports mark function.
8	File list switch button	<ul style="list-style-type: none"> <li>● Double click it, user may view the picture/record file list of current day.</li> <li>● The file list is to display the first channel of the record file.</li> <li>● The system can display max 128 files in one time. Click Play button to view the file. Select one item, and then click the mouse or click the Play button to playback.</li> <li>● User may input the period in the following interface to begin accurate search.</li> <li>● File type: R—regular record; A—external alarm record; M—Motion detect record.</li> </ul>  <ul style="list-style-type: none"> <li>● Lock file. Click the file you want to lock and click the button  to lock. The file you locked will not be overwritten.</li> <li>● Search locked file: Click the button  to view the locked file.</li> <li>● Return: Click button , system goes back to the calendar and channel setup interface.</li> </ul> <p>Please note:</p> <ul style="list-style-type: none"> <li>● For the file that is writing or overwriting, it can not be locked.</li> </ul>
9	Playback control pane.	 <p>Play/Pause There are three ways for you to begin playback.</p> <ul style="list-style-type: none"> <li>● The play button</li> <li>● Double click the valid period of the time bar.</li> <li>● Double click the item in the file list.</li> </ul> <p>In slow play mode, click it to switch between play/pause.</p>
		 <p>Stop</p>
		 <p>Backward play In normal play mode, left click the button, the file begins backward play. Click it again to pause current play. In backward play mode, click  to restore normal play.</p>
		 <p>In playback mode, click it to play the next or the previous section. User may click continuously when you are watching the files from the same channel.</p>

		<p>In normal play mode, when you pause current play, user may click ◀  and  ▶ to begin frame by frame playback.</p> <p>In frame by frame playback mode, click ▶/   to restore normal playback.</p>
		<p>▶ Slow play</p> <p>In playback mode, click it to realize various slow play modes such as slow play 1, slow play 2, and etc.</p>
		<p>▶▶ Fast forward</p> <p>In playback mode, click to realize various fast play modes such as fast play 1, fast play 2 and etc.</p>
		Note: The actual play speed has relationship with the software version.
		 Smart search
		 The volume of the playback
		 <p>Click the snapshot button in the full-screen mode, the system can snapshot 1 picture.</p> <p>System supports custom snap picture saved path. Please connect the peripheral device first, click snap button on the full-screen mode, user may select or create path. Click Start button, the snapshot picture can be saved to the specified path.</p>
		 <p>Mark button.</p> <p>Please note this function is for some series product only. Please make sure there is a mark button in the playback control pane.</p> <p>User may refer to chapter 3.12.5 for detailed information.</p>
		 <p>In 1-window playback mode, click it to overlay POS information.</p>
		 <p>In 1-window playback mode, click it to overlay IVS rule information.</p>
10	Time bar	<ul style="list-style-type: none"> <li>● It is to display the record type and its period in current search criteria.</li> <li>● In 4-window playback mode, there are corresponding four time bars. In other playback mode, there is only one time bar.</li> <li>● Use the mouse to click one point of the color zone in the time bar, system begins playback.</li> <li>● The time bar is beginning with 0 o'clock when you are setting the configuration. The time bar zooms in the period of the current playback time when you are playing the file.</li> <li>● The green color stands for the regular record file. The red color stands for the external alarm record file. The yellow stands for the motion detect record file.</li> </ul>
11	Time bar unit	<ul style="list-style-type: none"> <li>● The option includes: 24H, 12H, 1H and 30M. The smaller the unit, the larger the zoom rate. User may accurately set the time in the time bar to playback the record.</li> <li>● The time bar is beginning with 0 o'clock when you are setting the configuration. The time bar zooms in the period of the current playback time when you are playing the file.</li> </ul>
12	Backup	<ul style="list-style-type: none"> <li>● Select the file(s) you want to backup from the file list. User may check from the</li> </ul>

		<p>list. Then click the backup button, now user may see the backup menu. System supports customized path setup. After select or create new folder, click the Start button to begin the backup operation. The record file(s) will be saved in the specified folder.</p> <ul style="list-style-type: none"> <li>● Check the file again user may cancel current selection. System max supports to display 32 files from one channel.</li> <li>● After you clip on record file, click Backup button user may save it.</li> <li>● For one device, if there is a backup in process, user may not start a new backup operation.</li> </ul>
13	Clip	<ul style="list-style-type: none"> <li>● It is to edit the file.</li> <li>● Please play the file you want to edit and then click this button when you want to edit. User may see the corresponding slide bars in the time bar of the corresponding channel. User may adjust the slide bar or input the accurate time to set the file end time.</li> <li>● After you set, user may click Clip button again to edit the second period. User may see the slide bar restore its previous position.</li> <li>● Click Backup button after clip, user may save current contents in a new file.</li> <li>● User may clip for one channel or multiple-channel. The multiple-channel click operation is similar with the one-channel operation.</li> </ul> <p>Please note:</p> <ul style="list-style-type: none"> <li>● <b>System max supports 1024 files backup at the same time.</b></li> <li>● <b>User may not operate clip operation if there is any file has been checked in the file list.</b></li> </ul>
14	Record type	In any play mode, the time bar will change once you modify the search type.
<b>Other Functions</b>		
15	Smart motion detect search	<ul style="list-style-type: none"> <li>● When system is playing, user may select a zone in the window to begin smart search. Click the motion detect button to begin play.</li> <li>● Once the motion detect play has begun, click button again will terminate current motion detect file play.</li> <li>● There is no motion detect zone by default.</li> <li>● If you select to play other file in the file list, system switches to motion detect play of other file.</li> <li>● During the motion detect play process, user may not implement operations such as change time bar, begin backward playback or frame by frame playback.</li> <li>● Please refer to chapter 3.12.4 Smart Search for detailed operation.</li> </ul>
16	Sync	In pane 14 of Figure 3-80, click Sync button, user may playback the files of different channels occurred at the same time.
17	Other channel synchronization switch to play	When playing the file, click the number button, system can switch to the same period of the corresponding channel to play.

	when playback	
18	Digital zoom	When the system is in full-screen playback mode, left click the mouse in the screen. Drag your mouse in the screen to select a section and then left click mouse to realize digital zoom. User may right click mouse to exit.

**Note:**

All the operations here (such as playback speed, channel, time and progress) have relationship with hardware version. Some series NVRs do not support some functions or playback speeds.

**3.12.3 Accurate Playback by Time**

Select records from one day, click the list, user may go to the file list interface. User may input time at the top right corner to search records by time. See image on the left side of the Figure 3-81 For example,

input time 11:00.00 and then click Search button , user may view all the record files after 11:00.00 (The records includes current time.). See image on the right side of the Figure 3-81 Double click a file name to playback.

**Note**

- After you searched files, system implement accurate playback once you click Play for the first time.
- System does not support accurate playback for picture.
- System supports synchronization playback and non-synchronous playback. The synchronization playback supports all channels and non-synchronous playback only supports accurately playback of current select channel.

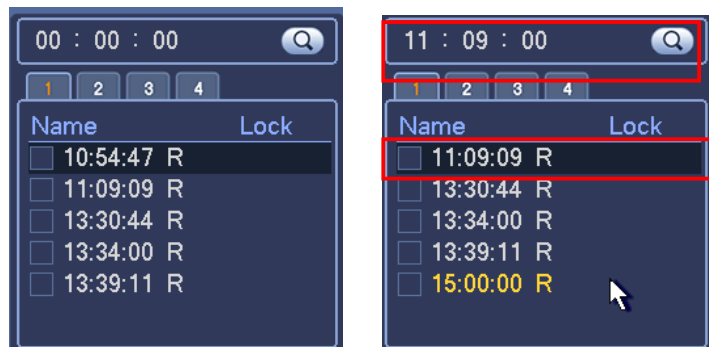



Figure 3-81

**3.12.4 Smart Motion Detect Search**

During the multiple-channel playback mode, double click one channel and then click the  button, system begins smart search. System supports 396(22\*18 PAL) and 330(22\*15 NTSC) zones. Please left click mouse to select smart search zones. See Figure 3-82.

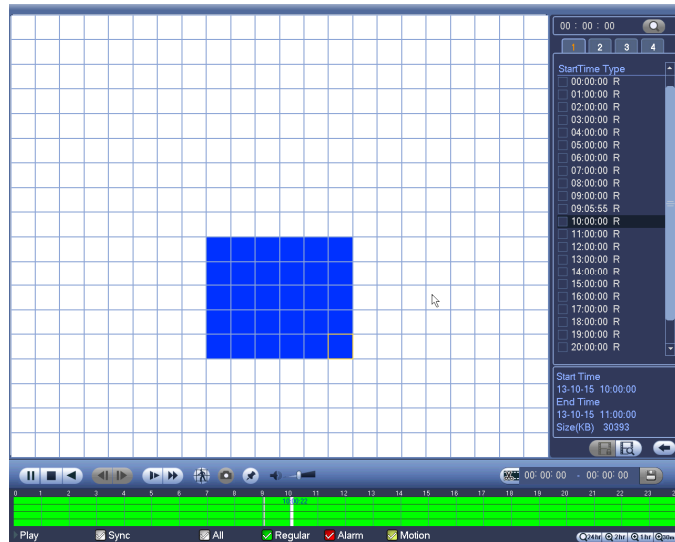



Figure 3-82

Click the , user may go to the smart search playback. Click it again, system stops smart search playback.

**Important**

- System does not support motion detect zone setup during the full-screen mode.
- During the multiple-channel playback, system stops playback of rest channels if you implement one-channel smart search.

**3.12.5 Mark Playback**

**Please make sure your purchased device support this function. User may use this function only if user may see the mark playback icon on the Search interface (Figure 3-80).**

When you are playback record, user may mark the record when there is important information. After playback, user may use time or the mark key words to search corresponding record and then play. It is very easy for you to get the important video information.

- Add Mark

When system is playback, click Mark button , user may go to the following interface. See Figure 3-83.

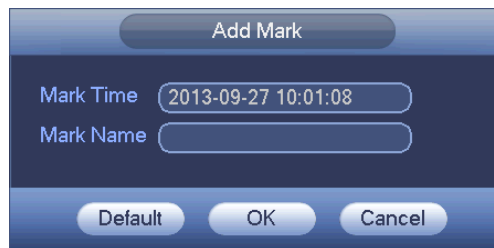



Figure 3-83

- Playback Mark

During 1-window playback mode, click mark file list button  in Figure 3-80, user may go to mark file list interface. Double click one mark file, user may begin playback from the mark time.

- Play before mark time

Here user may set to begin playback from previous N seconds of the mark time.

**Note**

Usually, system can playback previous N seconds record if there is such kind of record file. Otherwise, system playbacks from the previous X seconds when there is such as kind of record.

- Mark Manager



Click the mark manager button on the Search interface (Figure 3-80); user may go to Mark Manager interface. See Figure 3-84. System can manage all the record mark information of current channel by default. User may view all mark information of current channel by time.

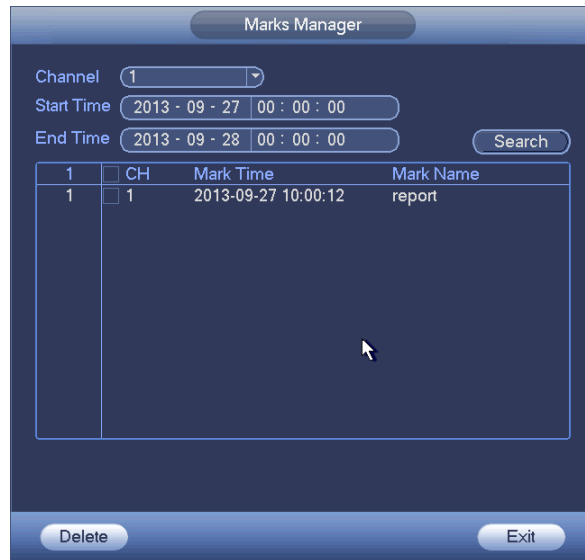

Figure 3-84

- Modify

Double click one mark information item, user may see system pops up a dialogue box for you to change mark information. User may only change mark name here.

- Delete

Here user may check the mark information item you want to delete and then click Delete button, user may remove one mark item. .

**Note**

- After you go to the mark management interface, system needs to pause current playback. System resume playback after you exit mark management interface.
- If the mark file you want to playback has been removed, system begin playbacking from the first file in the list.

**3.12.6 Picture Playback**

- From Main menu->Search, or on the preview interface right click mouse, user may go to Figure 3-80.
- At the top right pane, user may check the box to select picture and then select playback interval.
- Please refer to chapter 3.12.2 to select picture you want to view.

### 3.12.7 Splice Playback

On the main menu, click Search button, or right click mouse and then select Search. User may go to the Figure 3-80.

On the right pane, select the search type as splice from the dropdown list (pane 2 in Figure 3-80 ), and then set channel, date, split mode

#### Note

Select split mode, so that the record can be spliced in several sections.

Select splice file.

- Click Playback, system playbacks from the first of current date by default.
- Click time bar, system playbacks from the time you click.
- Click , user may select on the file list.

#### Note

- System can auto slice file of one channel into 4/8/16 sections and then play at the same time.
- User may select channel mode to set splice amount. There is no splice operation if you select 1-window.
- The record min file size is 5 minutes.

### 3.12.8 Smart Playback

This function includes face detect and behavior analytics.

On the main menu, click Smart play, the interface is shown as below. See Figure 3-85.

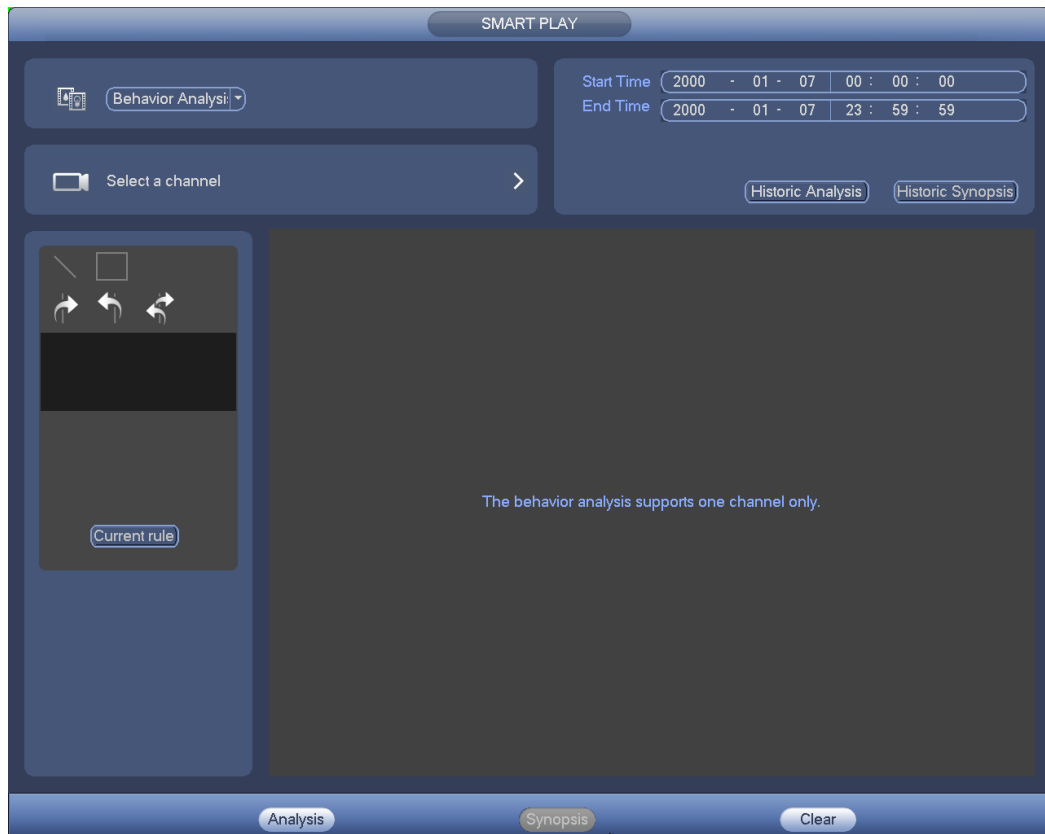

Figure 3-85

### 3.12.8.1 Behavior Analysis

It is to search the record of corresponding rule and then playback.

Set a channel number. Please note this function is for 1-channel mode only.

Set the search type as behavior analytics, set channel, start time and end time.

Set detect rule (tripwire/intrusion), and then set detect rule.

#### 3.12.8.1.1 Tripwire

Click  and then use mouse to draw the rule on the right pane of the interface. Left click mouse to confirm first and then right click mouse to complete drawing. Here user may set rule direction. See Figure 3-86.

- Line1/2/3/4: System supports four tripwires. Each SN stands for one tripwire.

- Direction (): System can generate an alarm once there is any object crossing in the specified direction.

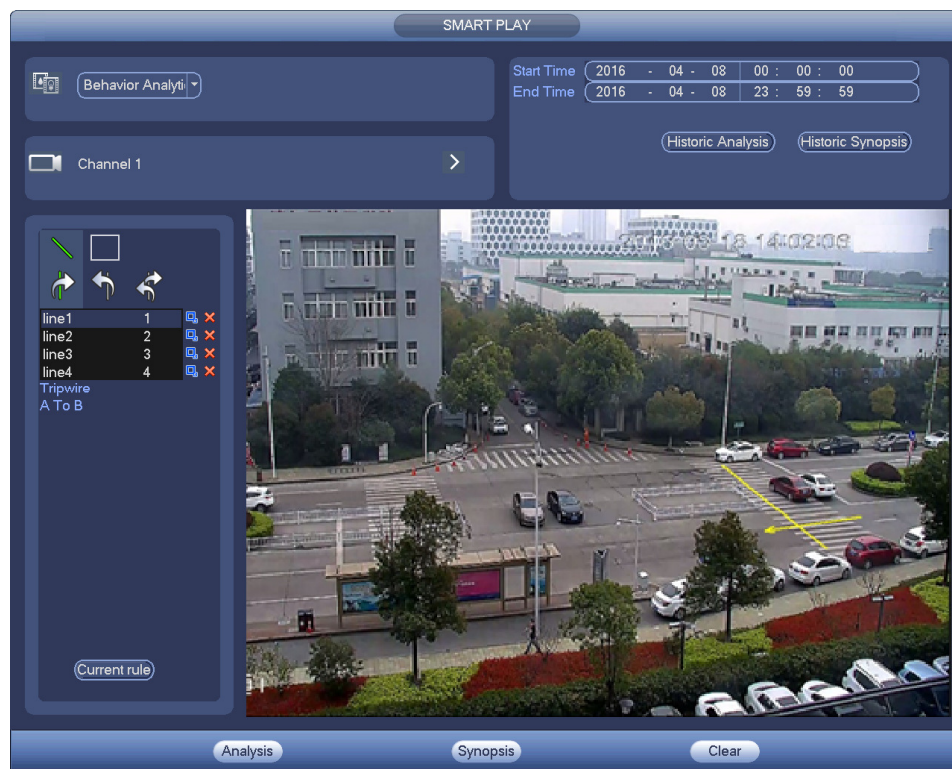



Figure 3-86

#### 3.12.8.1.2 Intrusion

Click , use mouse to draw the rule on the right pane of the interface. Please note the start position and the end position shall be at the same place. Right click mouse to complete the setup. See Figure 3-87.

- Area1/2/3/4: System supports four zones. Each SN stands for one area.

- Direction (): System can generate an alarm once there is any object



enter/exit (Or both) the zone.

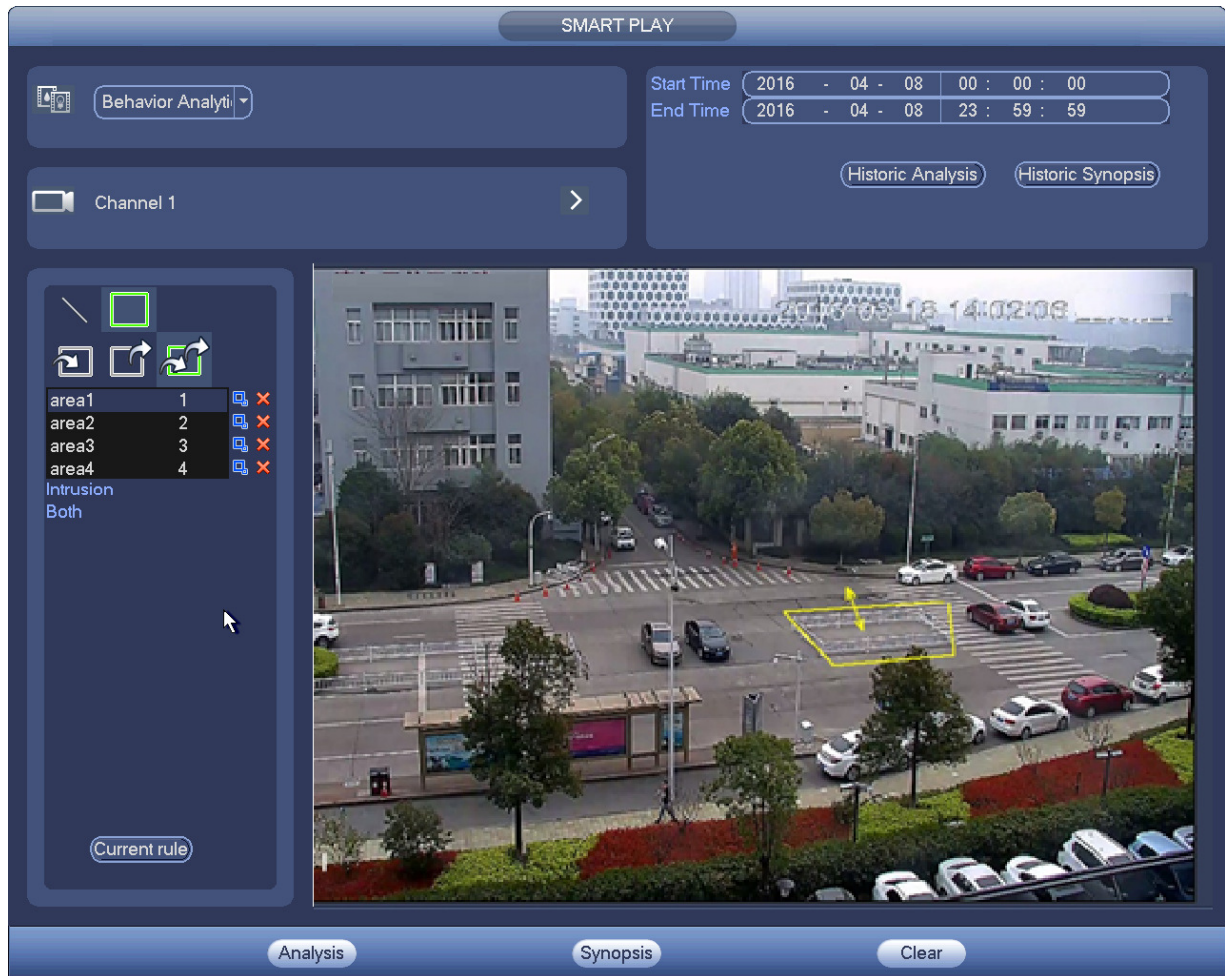

Figure 3-87

### Tips

Click Current rule button, user may use the rule you set in chapter 3.14.2 (Main menu->Setting->Event->Behavior Analytics) to detect.

Click Historic analysis button at the right pane or Analysis button at the bottom of the interface, system begins analyzing, and display the image of the corresponding event. See Figure 3-88.

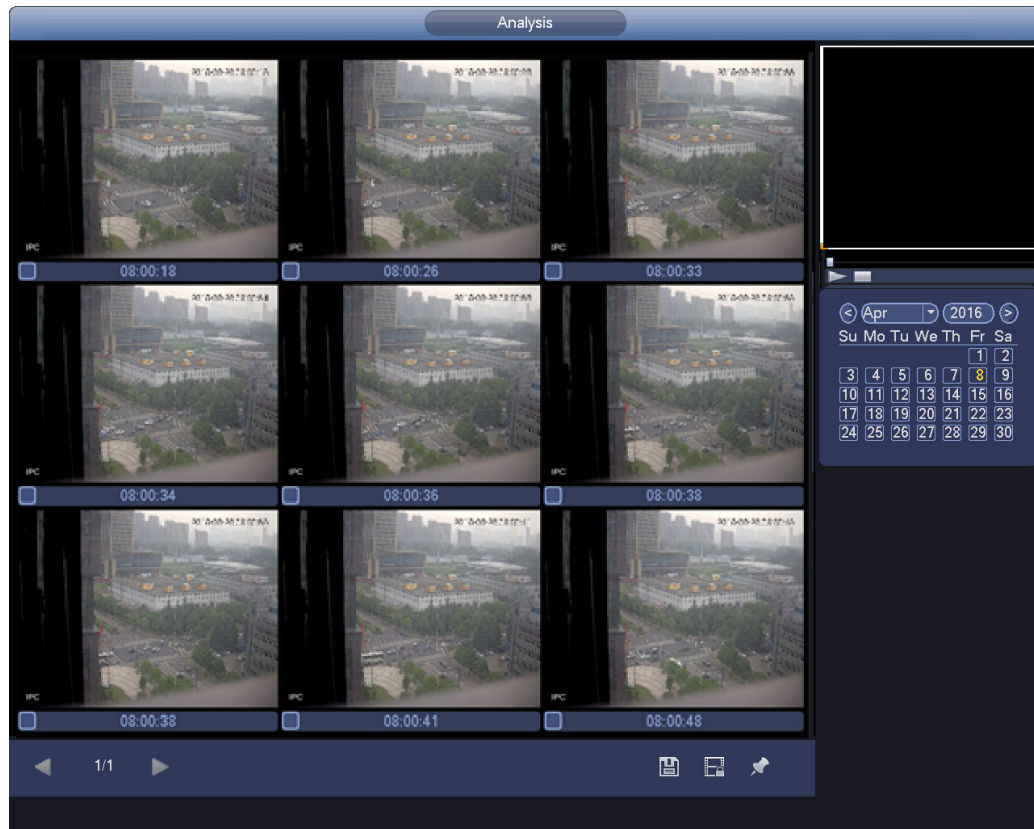





Figure 3-88

Click the image; user may view the record file.

- Select a file and then click , user may save current file to peripheral storage device.
- Select a file and then click , user may lock current file in case it will be overwritten in the future
- Select a file and then click , user may mark the time of the detected event.

In smart playback interface (Figure 3-85), click Clear button, user may delete detection and behavior analytics rule(s) of current channel.

### 3.12.8.2 Face Detect Playback

System can search the record containing the human face and then playback.



#### **Important**

Before you use this function, please make sure current channel has enabled human face detection function. Please refer to chapter 3.14.4 (Main menu->Setting->Event->Face Detection) for detailed information.

Set the search type as face detect, set channel, start time and end time.

Click Historic analysis button at the right pane or Analysis button at the bottom of the interface, system begins to search. User may view the event time and image. See Figure 3-89.

Click the image, system begins playback.

- Select the file and then click , user may save current file to peripheral device.
- Select the file and then click , user may lock the file in case it will be overwritten in the future.
- Select the file and then click , user may mark the time of the detected event.

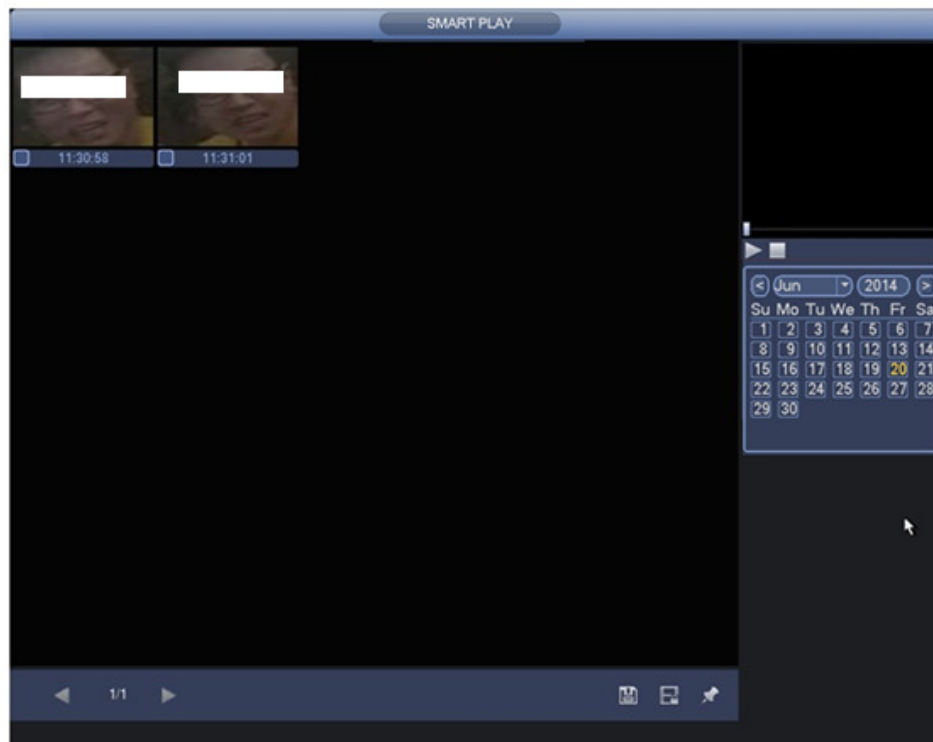

Figure 3-89

### 3.12.8.3 Video Synopsis

System can analyze the moving object, extract the moving object and merge different moving objects to one common background. In this way, it can display all moving objects and persons in the specified period to one window for you to view.

On smart search interface, select detection type, channel, start time and end time.

Click Synopsis button at the bottom of the interface; user may see the following interface. See Figure 3-90.

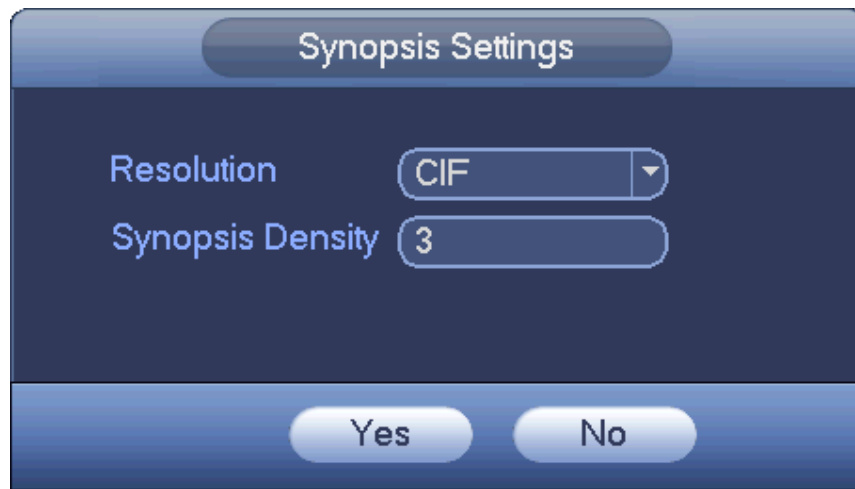

Figure 3-90

Input resolution and synopsis density, click the OK button.

User may view the image after the synopsis process. See Figure 3-91.

Click the green rectangle; user may playback the record at the top right corner of the interface.

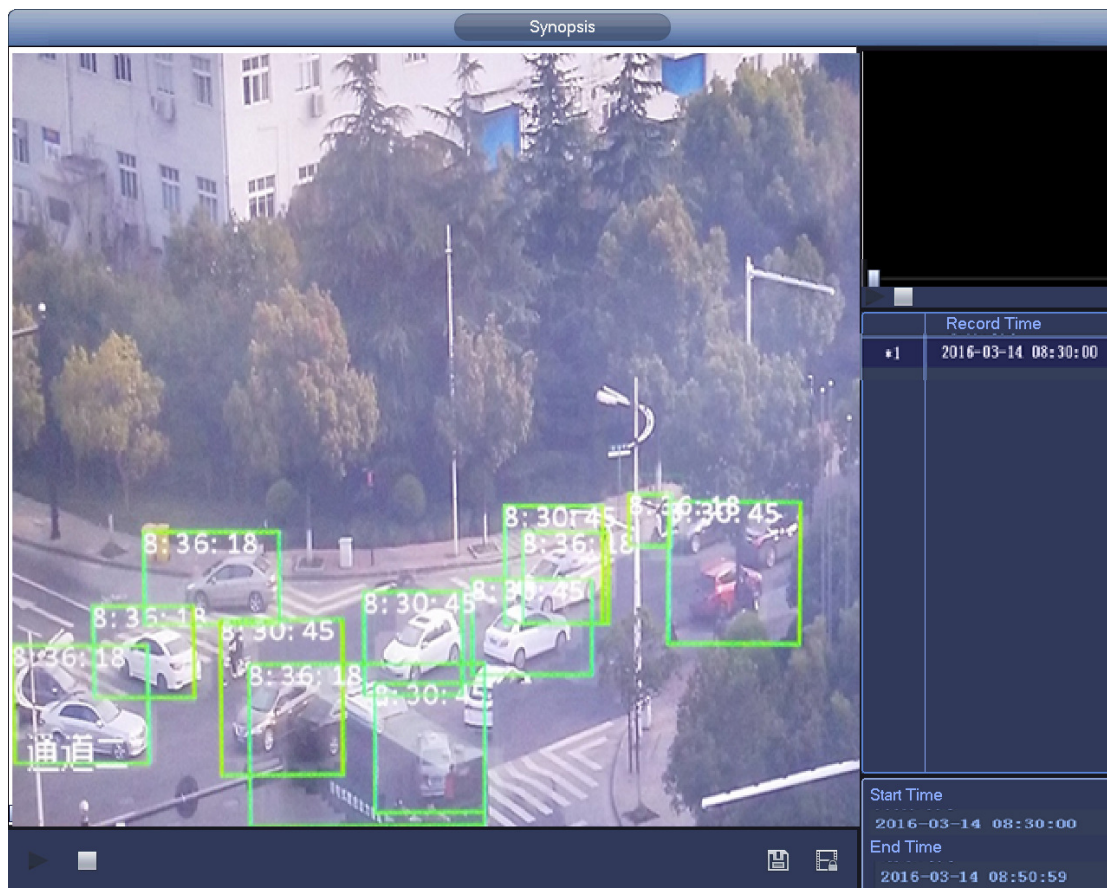

Figure 3-91

**Tips**

Click Historic synopsis, user may view the previous synopsis image.

## 3.13 Backup

### 3.13.1 File Backup

In this interface, user may backup record file to the USB device.

- Connect USB burner, USB device or portable HDD and etc. to the device. User may see the detected device name and storage space, status.
- From Main menu->Backup, user may go to the Backup interface. See Figure 3-92.

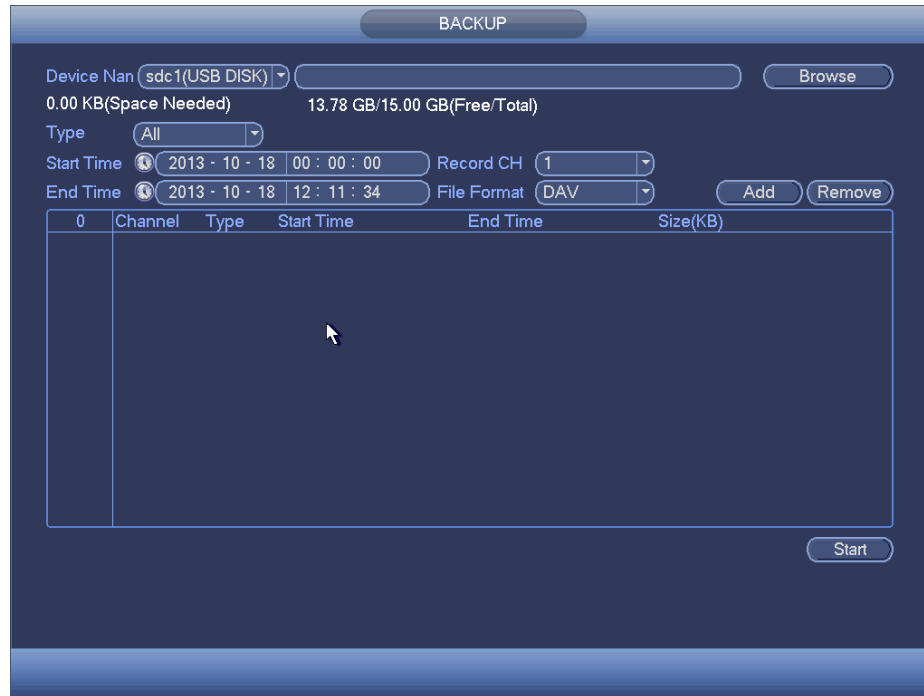

Figure 3-92

- Select backup device and then set channel, file start time and end time.
- Click add button, system begins search. All matched files are listed below. System automatically calculates the capacity needed and remained. See Figure 3-93.
- System only backup files with a ✓ before channel name. User may use Fn or cancel button to delete ✓ after file serial number.
- Click backup button, user may backup selected files. There is a process bar for you reference.
- When the system completes backup, user may see a dialogue box prompting successful backup.

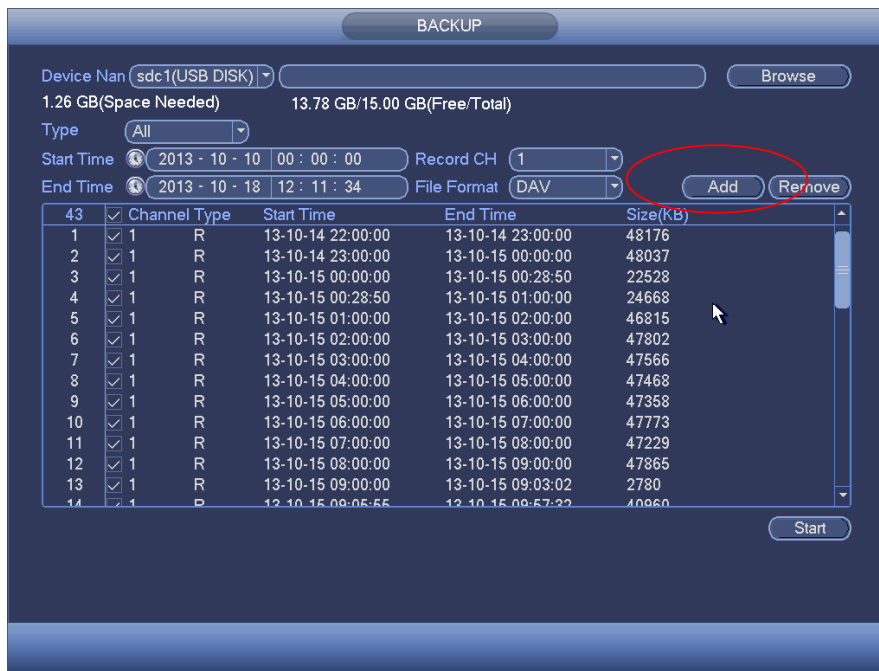

Figure 3-93

- h) Click backup button, system begins burning. At the same time, the backup button becomes stop button. User may view the remaining time and process bar at the left bottom.

**Note**

- During backup process, user may click ESC to exit current interface for other operation (For some series product only). The system will not terminate backup process.
- The file name format usually is: Channel number+Record type+Time. In the file name, the YDM format is Y+M+D+H+M+S. File extension name is .dav.

**3.13.2 Import/Export**

This function allows you to copy current system configuration to other devices. It also supports import, create new folder, and delete folder and etc function.

From Main menu->Setting->System->Import/Export, user may see the configuration file backup interface is shown as below. See Figure 3-94.

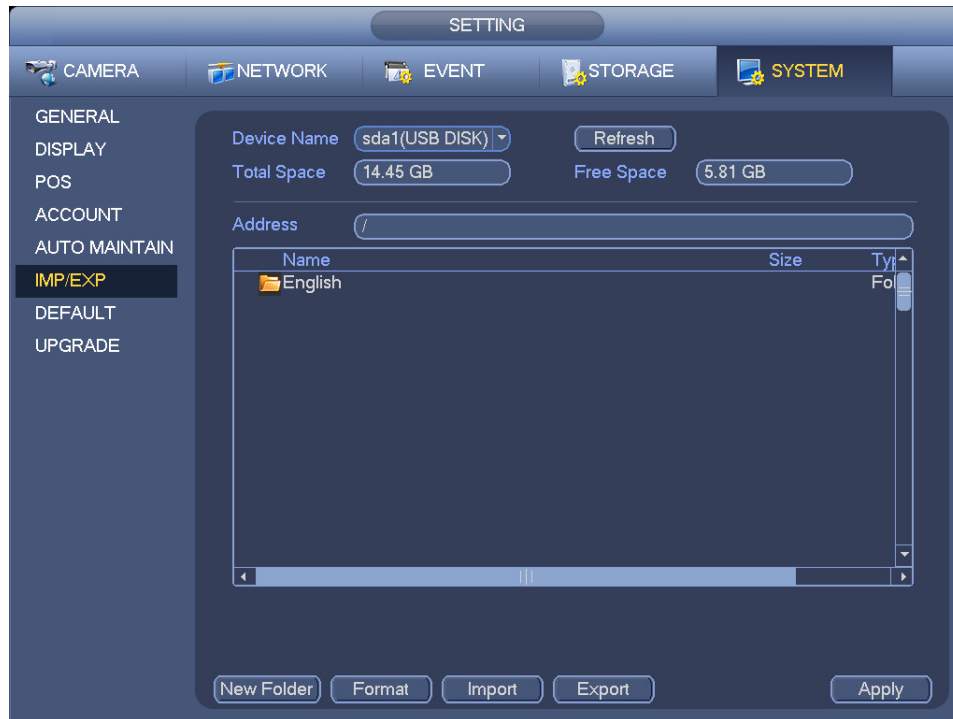

Figure 3-94

- Export: Please connect the peripheral device first and then go to the following interface. Click Export button, user may see there is a corresponding “Config\_Time” folder. Double click the folder, user may view some backup files.
- Import: Here user may import the configuration files from the peripheral device to current device. You need to select a folder first. User may see a dialogue box asking you to select a folder if you are selecting a file. System pops up a dialogue box if there is no configuration file under current folder. After successfully import, system needs to reboot to activate new setup.
- Format: Click Format button, system pops up a dialogue box for you to confirm current operation. System begins format process after you click the OK button.

**Note:**

- System can not open config backup interface again if there is backup operation in the process.
- System refreshes device when you go to the config backup every time and set current directory as the root directory of the peripheral device.
- If you go to the configuration backup interface first and then insert the peripheral device, please click Refresh button to see the newly added device.

**3.13.3 Backup Log**

- a) From Main menu->Info->Log, the interface is shown as below. See Figure 3-95.



Figure 3-95

- b) Select log type and then set start time/end time, click Search button, user may see log time and event information. Click  to view detailed log information.
- c) Select log items you want to save and then click backup button, user may select a folder to save them. Click Start to backup and user may see the corresponding dialogue box after the process is finish.

### 3.13.4 USB Device Auto Pop-up

After you inserted the USB device, system can auto detect it and pop up the following dialogue box. It allows you to conveniently backup file, log, configuration or update system. See Figure 3-96. Please refer to chapter 3.13.1 file backup, chapter 3.13.3 backup log, chapter 3.13.2 import/export, and chapter 3.12.2 search for detailed information.



Figure 3-96



## 3.14 Alarm





### 3.14.1 Video Detect

In the main menu, from Setting to Video detect, user may see the following interface. See Figure 3-97. There are three detection types: motion detection, video loss, tampering.

#### 3.14.1.1 Motion Detect

After analysis video, system can generate a motion detect alarm when the detected moving signal reached the sensitivity you set here. System max supports 4 detect zones.

From main menu->Setting->Video detect->motion detect, motion detection menu is shown as below. See Figure 3-97.

- Event type: From the dropdown list user may select motion detection type.
  - Channel: Select a channel from the dropdown list to set motion detect function.
  - Enable: Check the box here to enable motion detect function.
  - Region: Click select button, the interface is shown as in Figure 3-98. Here user may set motion detection zone. There are four zones for you to set. Please select a zone first and then left drag the mouse to select a zone. The corresponding color zone displays different detection zone. User may click Fn button to switch between the arm mode and disarm mode. In arm mode, user may click the direction buttons to move the green rectangle to set the motion detection zone. After you completed the setup, please click ENTER button to exit current setup. Do remember click save button to save current setup. If you click ESC button to exit the region setup interface system will not save your zone setup.
  - Sensitivity: System supports 6 levels. The sixth level has the highest sensitivity.
  - Anti-dither: Here user may set anti-dither time. The value ranges from 5 to 600s. The anti-dither time refers to the alarm signal lasts time. It can be seem as the alarm signal activation stays such as the buzzer, tour, PTZ activation, snapshot, channel record. The stay time here does not include the latch time. During the alarm process, the alarm signal can begin an anti-dither time if system detects the local alarm again. The screen prompt, alarm upload, email and etc will not be activated. For example, if you set the anti-dither time as 10 second, user may see the each activation may last 10s if the local alarm is activated. During the process, if system detects another local alarm signal at the fifth second, the buzzer, tour, PTZ activation, snapshot, record channel will begin another 10s while the screen prompt, alarm upload, email will not be activated again. After 10s, if system detects another alarm signal, it can generate an alarm since the anti-dither time is out.
  - Period: Click set button, user may see an interface is shown as in Figure 3-100. Here user may set motion detect period. System only enables motion detect operation in the specified periods. It is not for video loss or the tampering. There are two ways for you to set periods. Please note system only supports 6 periods in one day.
- ✧ In Figure 3-100, Select icon  of several dates, all checked items can be edited together. Now the icon is shown as . Click  to delete a record type from one period.
- ✧ In Figure 3-100. Click button  after one date or a holiday, user may see an interface shown as in Figure 3-101. There are four record types: regular, motion detection (MD), Alarm, MD & alarm.
- Alarm output: when an alarm occurs, system enables peripheral alarm devices.
  - Latch: when motion detection complete, system auto delays detecting for a specified time. The value ranges from 1-300(Unit: second)

- Show message: System can pop up a message to alarm you in the local host screen if you enabled this function.
- Alarm upload: System can upload the alarm signal to the network (including alarm centre) if you enabled current function.
- Send email: System can send out email to alert you when an alarm occurs.
- Record channel: System auto activates motion detection channel(s) to record once an alarm occurs. Please make sure you have set MD record in Schedule interface(Main Menu->Setting->Schedule) and schedule record in manual record interface(Main Menu->Advanced->Manual Record)
- PTZ activation: Here user may set PTZ movement when an alarm occurs. Such as go to preset, tour & pattern when there is an alarm. Click “select” button, user may see an interface is shown as in Figure 3-99.
- Record Delay: System can delay the record for specified time after alarm ended. The value ranges from 10s to 300s.
- Tour: Here user may enable tour function when an alarm occurs. System one-window tour.
- Snapshot: User may enable this function to snapshot image when a motion detect alarm occurs.
- Log: Check the box here, system can record motion detect log.
- Buzzer: Highlight the icon to enable this function. The buzzer beeps when an alarm occurs.

Please highlight icon  to select the corresponding function. After all the setups please click save button, system goes back to the previous menu.

**Note:**

In motion detection mode, user may not use copy/paste to set channel setup since the video in each channel may not be the same.

In Figure 3-98, user may left click mouse and then drag it to set a region for motion detection. Click Fn to switch between arm/withdraw motion detection. After setting, click enter button to exit.



Figure 3-97

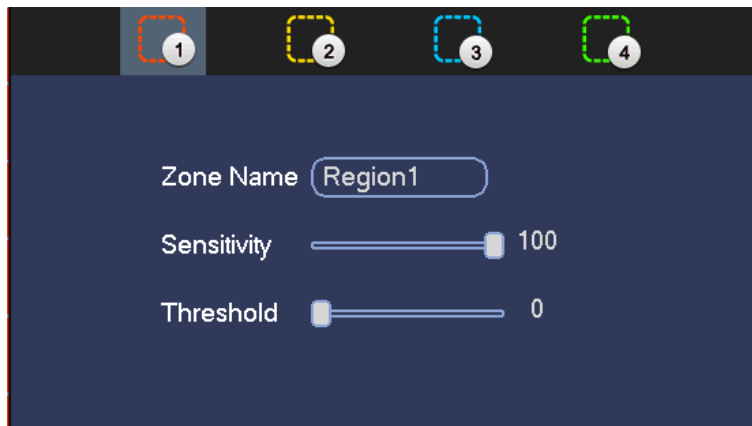

Figure 3-98



Figure 3-99

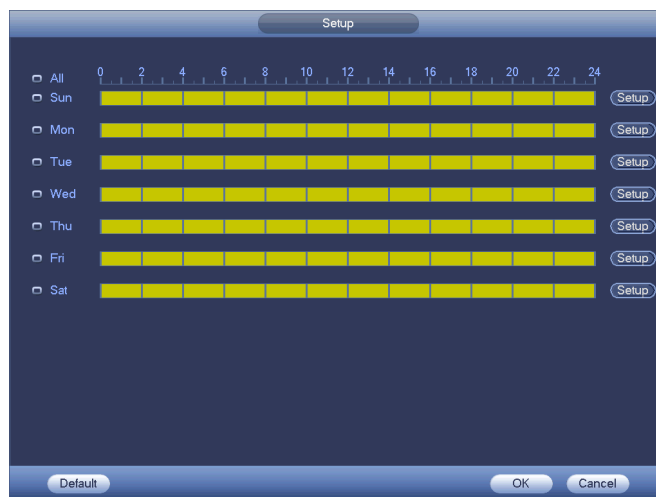

Figure 3-100



Figure 3-101

Motion detect here only has relationship with the sensitivity and region setup. It has no relationship with other setups.

### 3.14.1.2 Video Loss

From main menu->Setting->Video detect->video loss, user may see the interface is shown as in Figure 3-102. This function allows you to be informed when video loss phenomenon occurred. User may enable alarm output channel and then enable show message function.

User may refer to chapter 3.14.1.1 Motion detect for detailed information.

**Tips:**

User may enable preset/tour/pattern activation operation when video loss occurs.



Figure 3-102

### 3.14.1.3 Tampering

When someone viciously masks the lens, or the output video is in one-color due to the environments light change, the system can alert you to guarantee video continuity. From main

menu->Setting->Video detect->Tampering, user may see tampering interface is shown as in Figure 3-103. User may enable “Alarm output “or “Show message” function when tampering alarm occurs.

- Sensitivity: The value ranges from 1 to 6. It mainly concerns the brightness. The level 6 has the higher sensitivity than level 1. The default setup is 3.

**Tips:**

User may enable preset/tour/pattern activation operation when video loss occurs.

Please refer to chapter 3.14.1.1 motion detection for detailed information.

**Note:**

- In Detect interface, copy/paste function is only valid for the same type, which means user may not copy a channel setup in video loss mode to tampering mode.
- About Default function. Since detection channel and detection type may not be the same, system can only restore default setup of current detect type. For example, if you click Default button at the tampering interface, user may only restore default tampering setup. It is null for other detect types.
- System only enables tampering function during the period you set here. It is null for motion detect or video loss type.



Figure 3-103

3.14.1.4 Scene Changing

When the detected scene has changed, system can generate an alarm.

From main menu->Setting->Event->Video detect->Scene change, the interface is shown as in Figure 3-104.

Please refer to chapter 3.14.1.1 motion detection for detailed information.



Figure 3-104

#### 3.14.1.5 Video Analytics

From main menu->Setting->Video detect->Video analytics, user may see the interface is shown as in Figure 3-105. This function allows you to be informed when video is blurry, overexposure or color cast occurs. Each channel has its own enable/disable button and analytics rule. User may enable alarm output channel and then enable show message function.

Please refer to chapter 3.14.1.1 motion detection for detailed information.

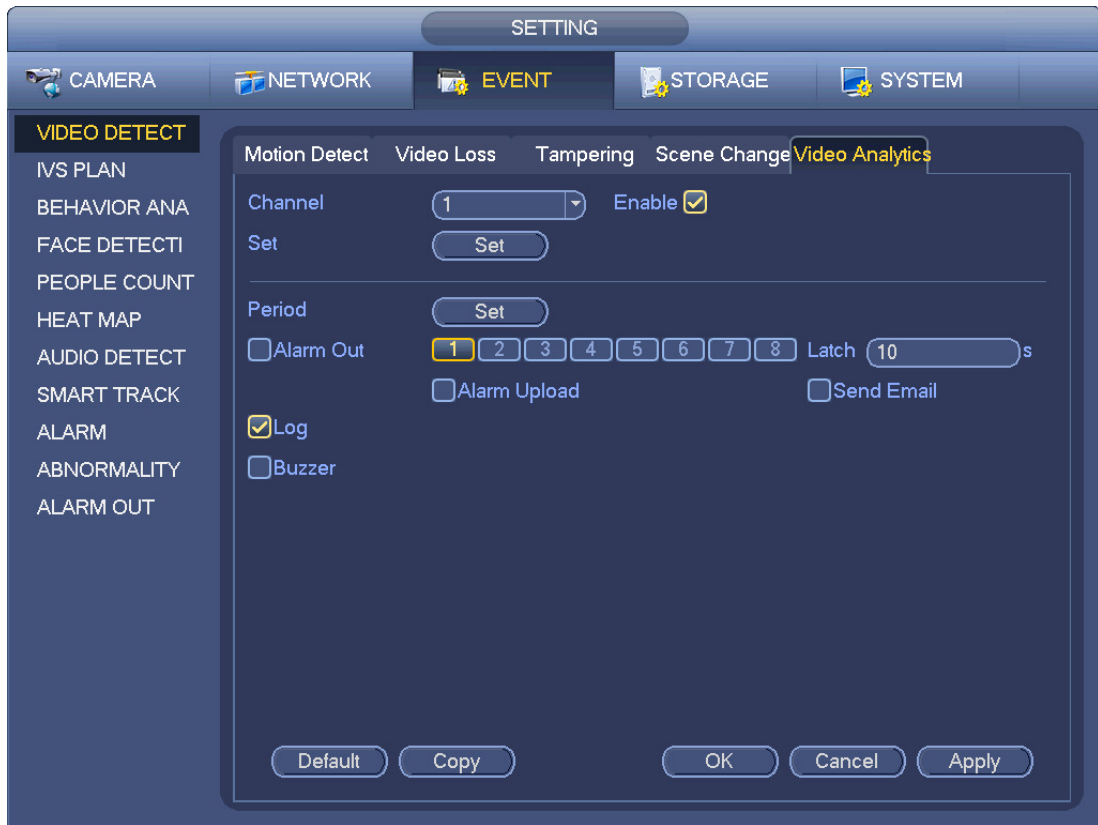

Figure 3-105

In Figure 3-105, click Set button, user may see the following interface. See Figure 3-106.



Figure 3-106

Check the box to set video diagnosis item (such as stripe) and then set alarm threshold (default setup is 30).

- Stripe: The strip occurs when the device is old or there is electronic interference. There may be cross

strip, vertical strip, slanting strip and etc.

- Noise: The video noise refers to the blurry video, poor video quality. It may result from the optical system distortion or the hardware problem during the video transmission when recording.
- Color cast: Usually the video is color containing RGB. When these three colors displayed in abnormal rate, we can say color cast occurred.
- Out of focus: The clear video presents abundant video details. The video definition decreases when the distortion event occurs. The out of focus event may result from many sources such as video transmission, processing and etc.
- Overexposure: The color brightness refers to the image pixel intensity. Black is the darkest and the white is the brightest. We use number 0 to stand for black and use number 255 to stand for white. Once the brightness threshold of the whole image has exceeded the threshold value, it means the image is over exposure.
- Threshold: The value ranges from 1 to 30. System can generate an alarm once the value is higher than the threshold you set here.

### 3.14.2 IVS Plan (Optional)

#### Important

**The IVS plans are for the smart camera. If you do not set a rule here, user may not use the intelligent functions in Behavior analytics (Chapter 3.14.3), Face detection (Chapter 3.14.4) and People counting (Chapter 3.14.5) when you are connecting to a smart camera.**

In this interface, user may quickly add an intelligent rule for one preset. The intelligent rule includes human face detection, behavior analytics and people counting.

From main menu->Setting->Event->IVS plan, the interface is shown as below. See Figure 3-107.

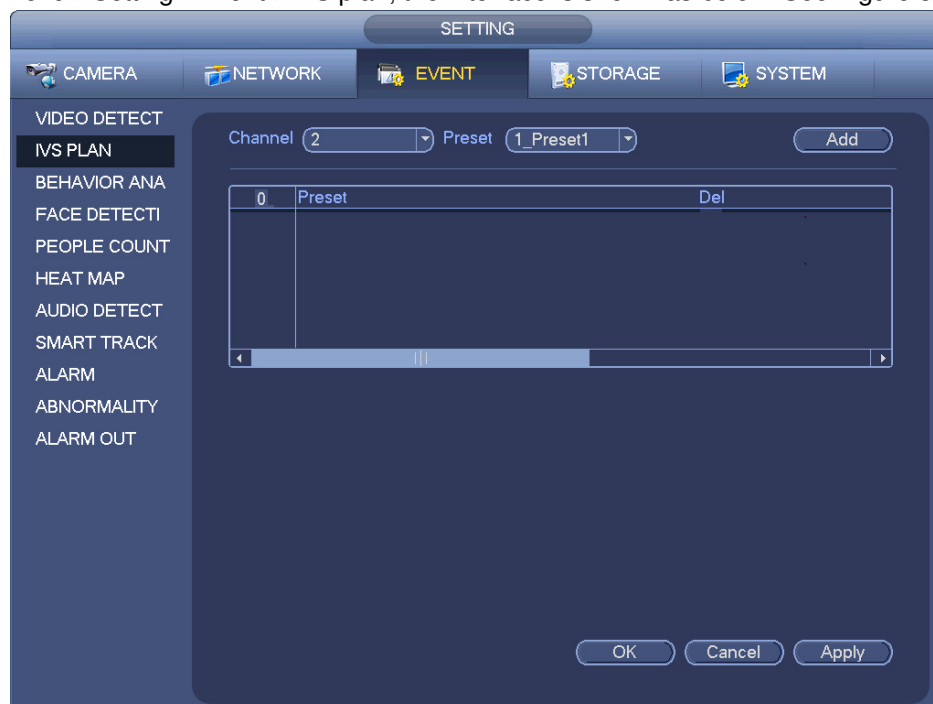

Figure 3-107

Please select a channel number and a preset.

Click Add and then select preset from the dropdown list and then add the intelligent plan. See Figure 3-108.



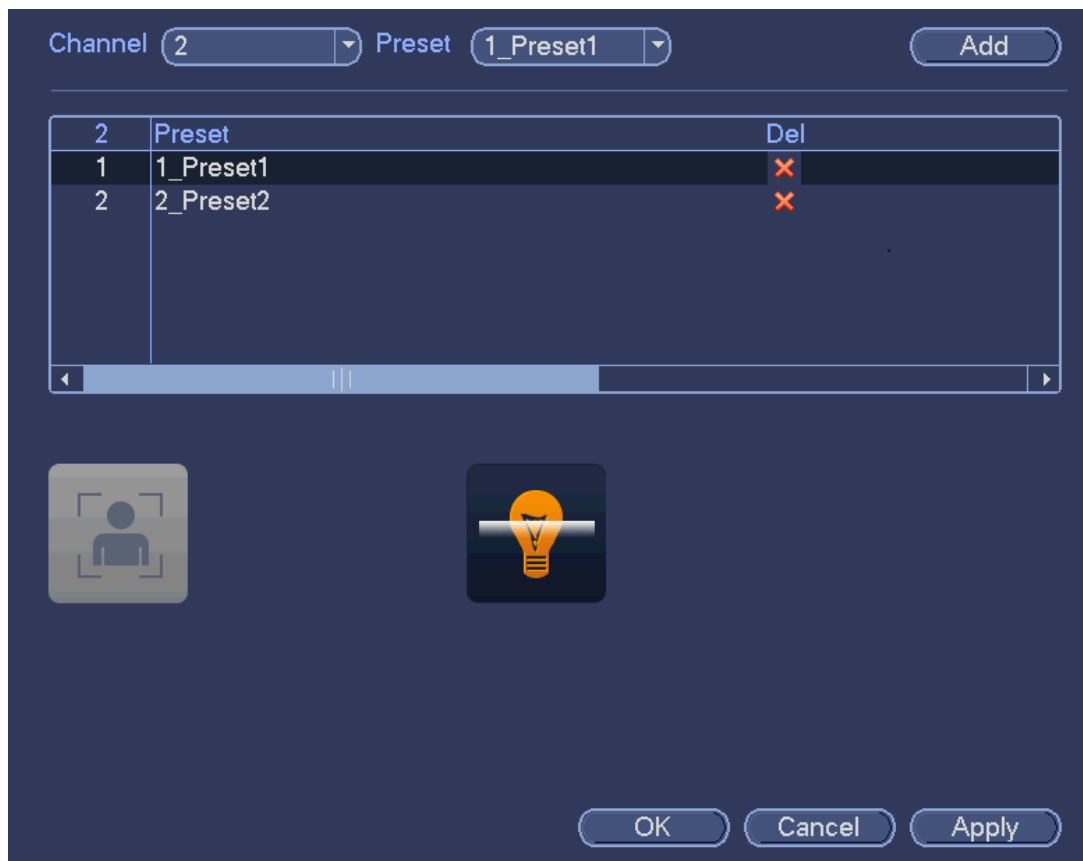

Figure 3-108

Click OK to complete the setup.

### 3.14.3 Behavior Analytics (Optional)



**Please contact your service engineer or local retailer if user maynot use IVS function.**

From main menu->Setting->Event->Behavior Analytics, user may go to the behavior analytics interface. Here user may set general behavior analytics rule. System can generate an alarm as the mode you previously set once there is any object violates the rule. See Figure 3-109.



Figure 3-109

Select a channel from the dropdown list.

Click Add button to add a rule and then select a rule type from the dropdown list.

Set corresponding parameters.

Click Apply button to complete the setup.

#### 3.14.3.1 Tripwire (Optional)

System generates an alarm once there is any object crossing the tripwire in the specified direction.

- The tripwire supports customized setup. It can be a straight line or a curve.
- Support one-direction or dual-direction detection.
- Support several tripwires at the same scene suitable for complicated environment.
- Support object size filter.

From main menu->Setting->Event->Behavior analytics, the interface is shown as below. See Figure 3-110.



Figure 3-110

Click Draw button  to draw the tripwire. See Figure 3-111.

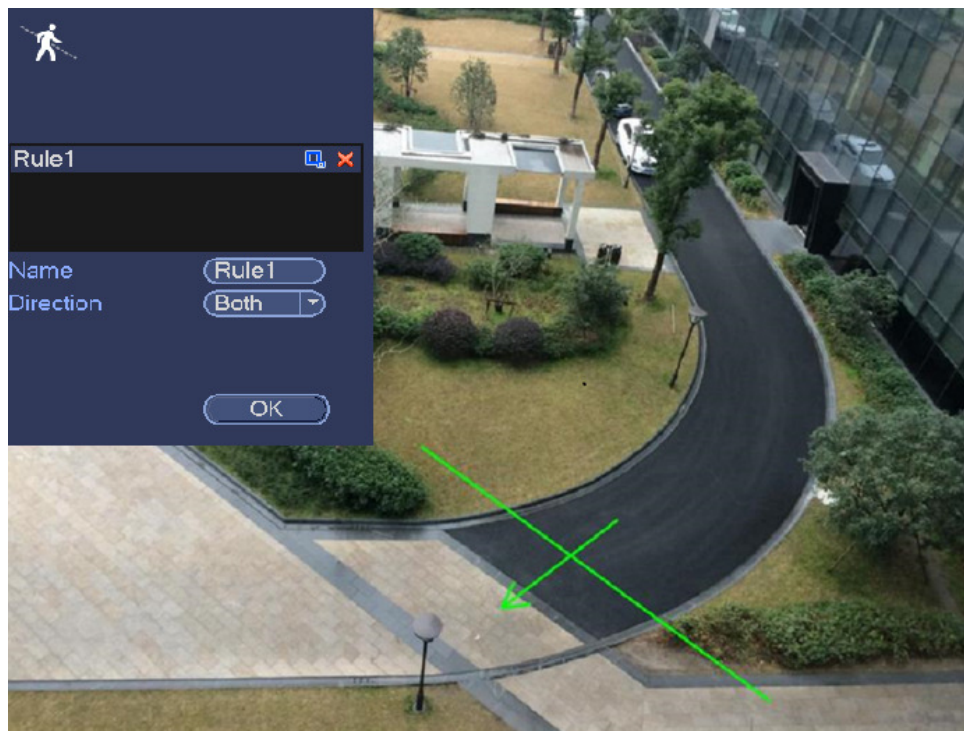



Figure 3-111

Select direction, and then input customized rule name.

- Preset: Select a preset you want to use behavior analytics.

- Name: Input customized rule name.
- Direction (A→B/B→A/A↔B): System can generate an alarm once there is any object crossing in the specified direction.
- Target filter: Click , user may set filter object size. Each rule can set two sizes (min size/max size). Once the object is smaller than the min size or larger than the max size, there is no alarm. Please make sure the max size is larger than the min size.

Now user may draw a rule. Left click mouse to draw a tripwire. The tripwire can be a direct line, curve or polygon. Right click mouse to complete.

### Tips



Click  to delete the corresponding rule.

Click , user may see the following interface. See Figure 3-112.

User may refer to the following information to set other parameters.

- Channel: Select a channel from the dropdown list to set tripwire function.
- Enable: Check the box here to enable tripwire function.
- Rule: input customized rule name here.
- Period: Click set button, user may see an interface is shown as in Figure 3-100. Here user may set tripwire period. System only enables tripwire operation in the specified periods. There are two ways for you to set periods. Please note system only supports 6 periods in one day.

◇ In Figure 3-100, Select icon  of several dates, all checked items can be edited together.

Now the icon is shown as . Click  to delete a record type from one period.

◇ In Figure 3-100. Click button  after one date or a holiday, user may see an interface shown as in Figure 3-101.

- Alarm output: when an alarm occurs, system enables peripheral alarm devices.
- Latch: when tripwire complete, system auto delays detecting for a specified time. The value ranges from 1-300(Unit: second)
- Show message: System can pop up a message to alarm you in the local host screen if you enabled this function.
- Alarm upload: System can upload the alarm signal to the network (including alarm centre) if you enabled current function.
- Send email: System can send out email to alert you when an alarm occurs.
- Record channel: System auto activates tripwire channel(s) to record once an alarm occurs. Please make sure you have set intelligent record in Schedule interface(Main Menu->Setting->Schedule) and schedule record in manual record interface(Main Menu->Advanced->Manual Record)
- PTZ activation: Here user may set PTZ movement when an alarm occurs. Such as go to preset, tour & pattern when there is an alarm. Click “select” button, user may see an interface is shown as in Figure 3-99.
- Record Delay: System can delay the record for specified time after alarm ended. The value ranges from 10s to 300s.
- Tour: Here user may enable tour function when an alarm occurs. System one-window tour.

- Snapshot: User may enable this function to snapshot image when a motion detect alarm occurs.
- Buzzer: Highlight the icon to enable this function. The buzzer beeps when an alarm occurs.
- Track/track time: Check the box here, user may input customized track time value. The unit is second.



Figure 3-112

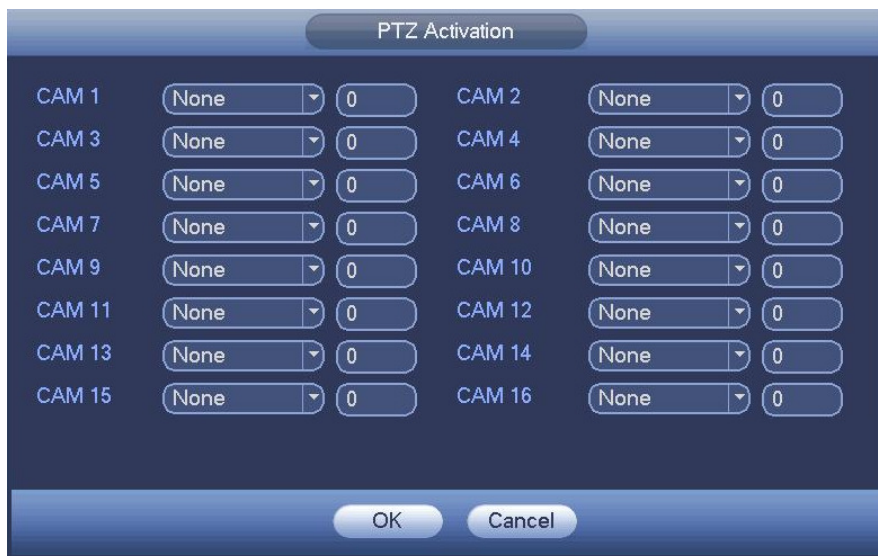

Figure 3-113

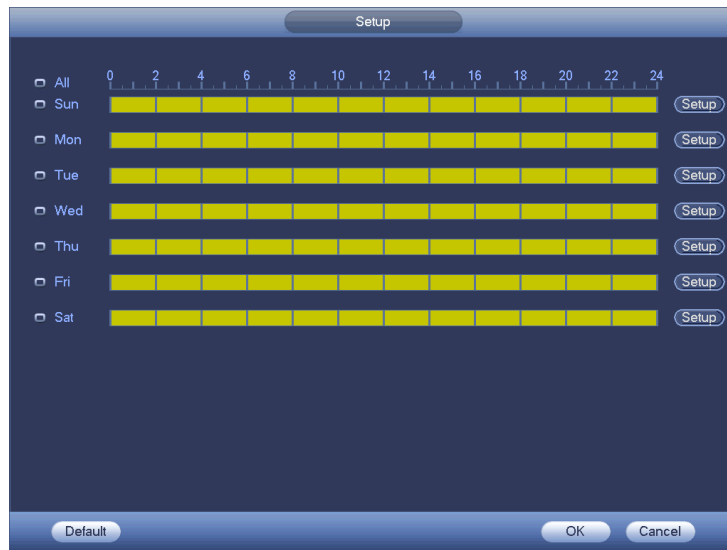

Figure 3-114



Figure 3-115

After you set the corresponding parameters, click OK button in Figure 3-112., and then click the Apply button in Figure 3-110 to complete the setup.

### 3.14.3.2 Intrusion (Cross warning zone) (Optional)

System generates an alarm once there is any object entering or exiting the zone in the specified direction. From main menu->Setting->Event->Behavior analytics, click Add button and then select type as intrusion, the interface is shown as below. See Figure 3-116.

- System supports customized area shape and amount.
- Support enter/leave/both detection.
- Can detect the moving object operation in the specified zone, customized trigger amount and staying time.
- Support objects filter function.



Figure 3-116

Click draw button  to draw the zone. See Figure 3-117.

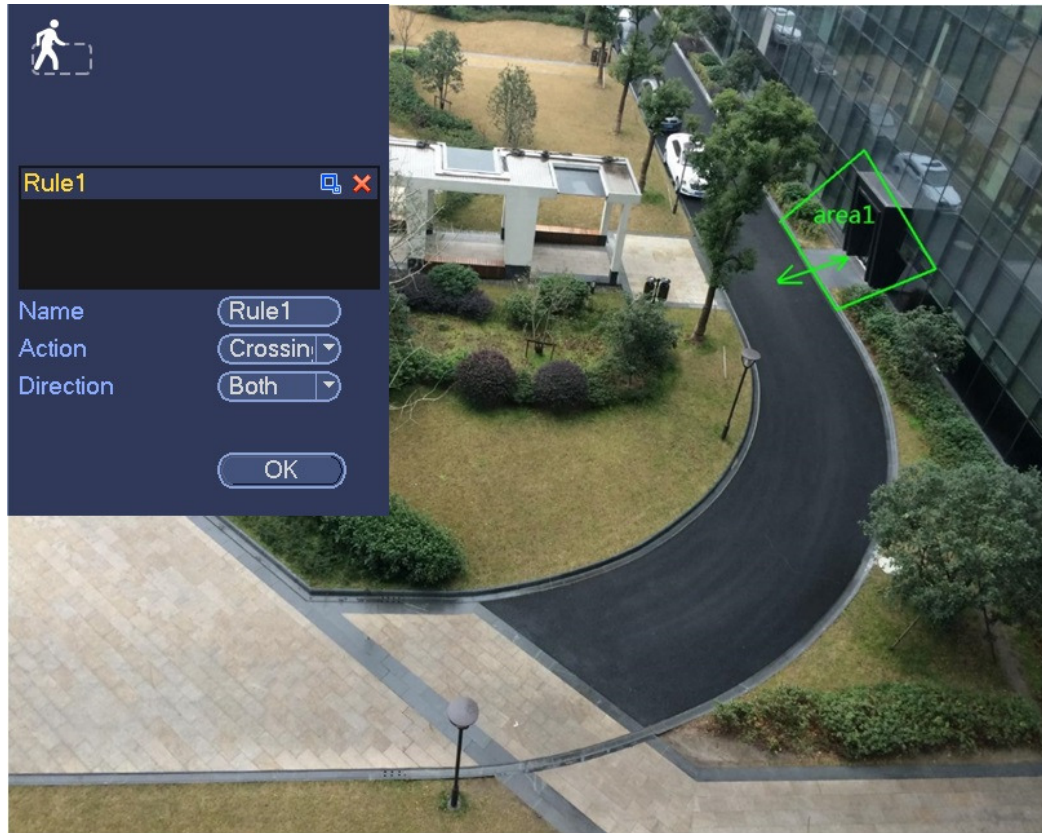



Figure 3-117

Select direction, and then input customized rule name.

- Preset: Select a preset you want to use behavior analytics.
- Name: Input customized rule name.
- Direction (A→B/B→A/A↔B): System can generate an alarm once there is any object crossing in the specified direction.
- Target filter: Click , user may set filter object size. Each rule can set two sizes (min size/max size).  
Once the object is smaller than the min size or larger than the max size, there is no alarm. Please make sure the max size is larger than the min size.

Now user may draw a rule. Left click mouse to draw a warning zone. Right click mouse to complete the setup.

#### Tips

Click  to delete the corresponding rule.

Click , user may refer to chapter 3.14.3.1 to set other parameters.

Click Apply to complete the setup.

#### 3.14.3.3 Abandoned Object Detect (Optional)

System generates an alarm when there is abandoned object in the specified zone.

From main menu->Setting->Event->Behavior analytics, select the type as abandoned object, the object interface is shown as below. See Figure 3-118.



- System supports customized area shape and amount.
- Support duration setup.
- Support objects filter function.



Figure 3-118

Click draw button  to draw the zone. See Figure 3-119.

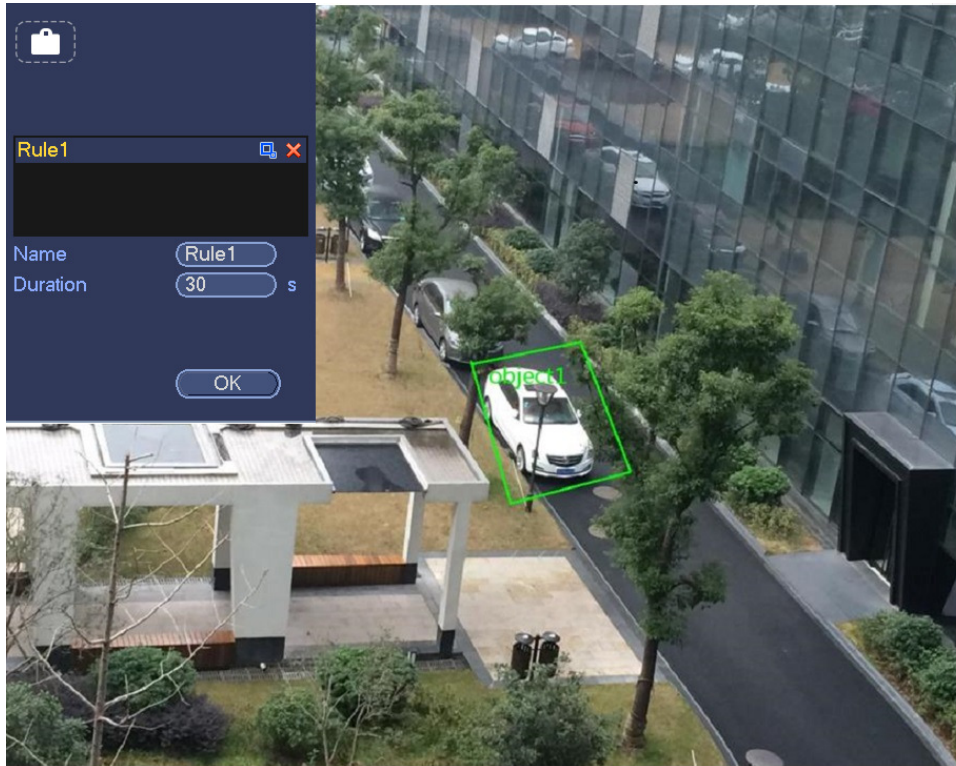



Figure 3-119

- Preset: Select a preset you want to use behavior analytics.
- Name: Input customized rule name.
- Duration: System can generate an alarm once the object is in the zone for the specified period.
- Target filter: Click , user may set filter object size. Each rule can set two sizes (min size/max size). Once the object is smaller than the min size or larger than the max size, there is no alarm. Please make sure the max size is larger than the min size.

Now user may draw a rule. Left click mouse to draw a zone, until you draw a rectangle, user may right click mouse.

#### Tips

Click  to delete the corresponding rule.

Click , user may refer to the chapter 3.14.3.1 to set other parameters.

Click Apply to complete the setup.

#### 3.14.3.4 Missing Object Detection (Optional)

System generates an alarm when there is missing object in the specified zone.

From main menu->Setting->Event->Behavior analytics, select the type as abandoned object, the object interface is shown as below. See Figure 3-120.

- System supports customized area shape and amount.
- Support duration setup.
- Support objects filter function.



Figure 3-120

Click Draw button  to draw a zone. See Figure 3-121.

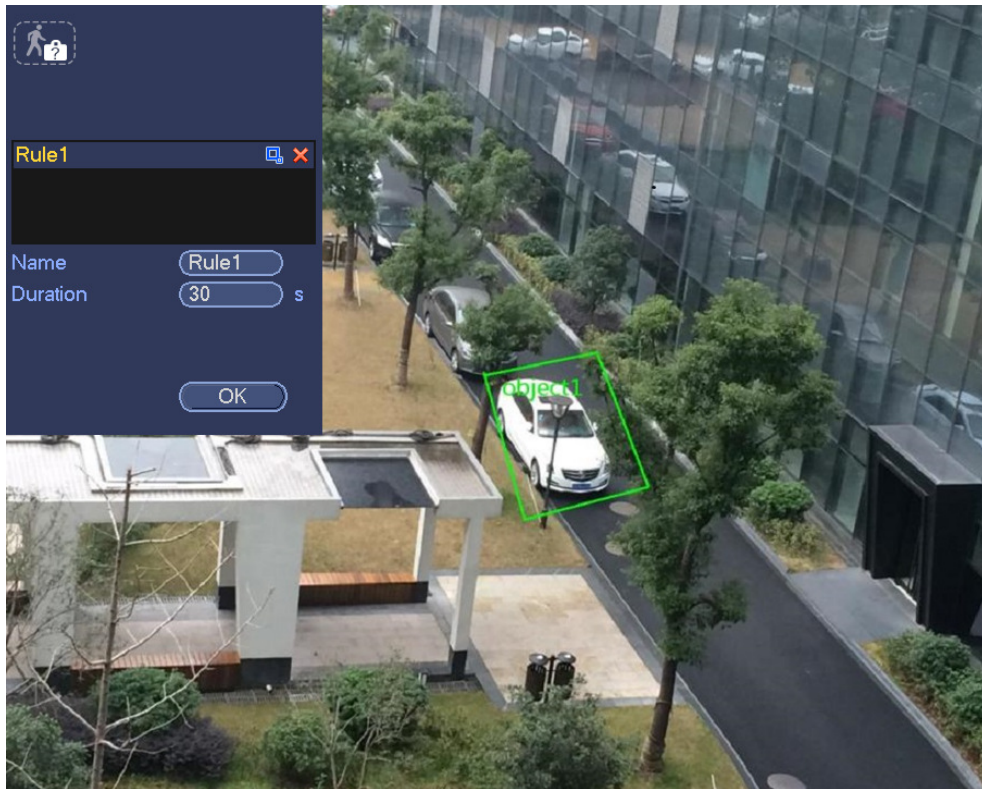



Figure 3-121

- Preset: Select a preset you want to use behavior analytics.
- Name: Input customized rule name.
- Duration: System can generate an alarm once the object in the zone is missing for the specified period.
- Target filter: Click , user may set filter object size. Each rule can set two sizes (min size/max size). Once the object is smaller than the min size or larger than the max size, there is no alarm. Please make sure the max size is larger than the min size.

Now user may draw a rule. Left click mouse to draw a zone, until you draw a rectangle, user may right click mouse.

### Tips

Click  to delete the corresponding rule.

Click , user may refer to the chapter 3.14.3.1 to set other parameters.

Click Apply to complete the setup.

### 3.14.3.5 Loitering Detection (Optional)

System can generate an alarm once the object is staying in the specified zone longer than the threshold. From main menu->Setting->Event->Behavior analytics, select the type as loitering, the object interface is shown as below. See Figure 3-122.

- System supports customized area shape and amount.
- Support duration setup.
- Support objects filter function.



Figure 3-122

Click draw button  to draw the zone. See Figure 3-123.

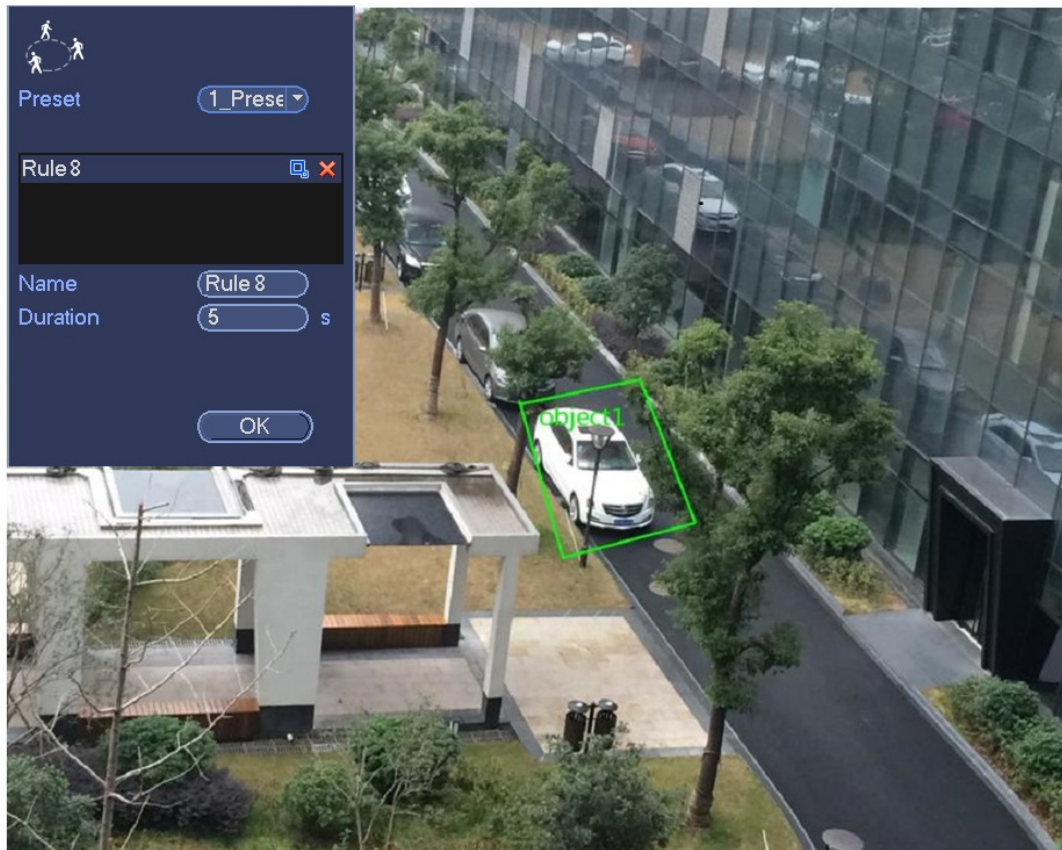



Figure 3-123

- Preset: Select a preset you want to use behavior analytics.
- Name: Input customized rule name.
- Duration: System can generate an alarm once the object is in the zone for the specified period.
- Target filter: Click , user may set filter object size. Each rule can set two sizes (min size/max size). Once the object is smaller than the min size or larger than the max size, there is no alarm. Please make sure the max size is larger than the min size.

Now user may draw a rule. Left click mouse to draw a zone, until you draw a rectangle, user may right click mouse.

#### Tips

Click  to delete the corresponding rule.

Click , user may refer to the chapter 3.14.3.1 to set other parameters.

Click Apply to complete the setup.

#### 3.14.3.6 Crowd Gathering Detection (Optional)

System can generate an alarm once the people amount gathering in the specified zone is larger than the threshold.

From main menu->Setting->Event->Behavior analytics, select the type as crowd gathering detect, the interface is shown as below. See Figure 3-124.

- Customized zone and amount setup.
- Duration setup.
- Sensitivity setup.
- Min gathering zone setup.



Figure 3-124

Click draw button  to draw the zone. See Figure 3-125.

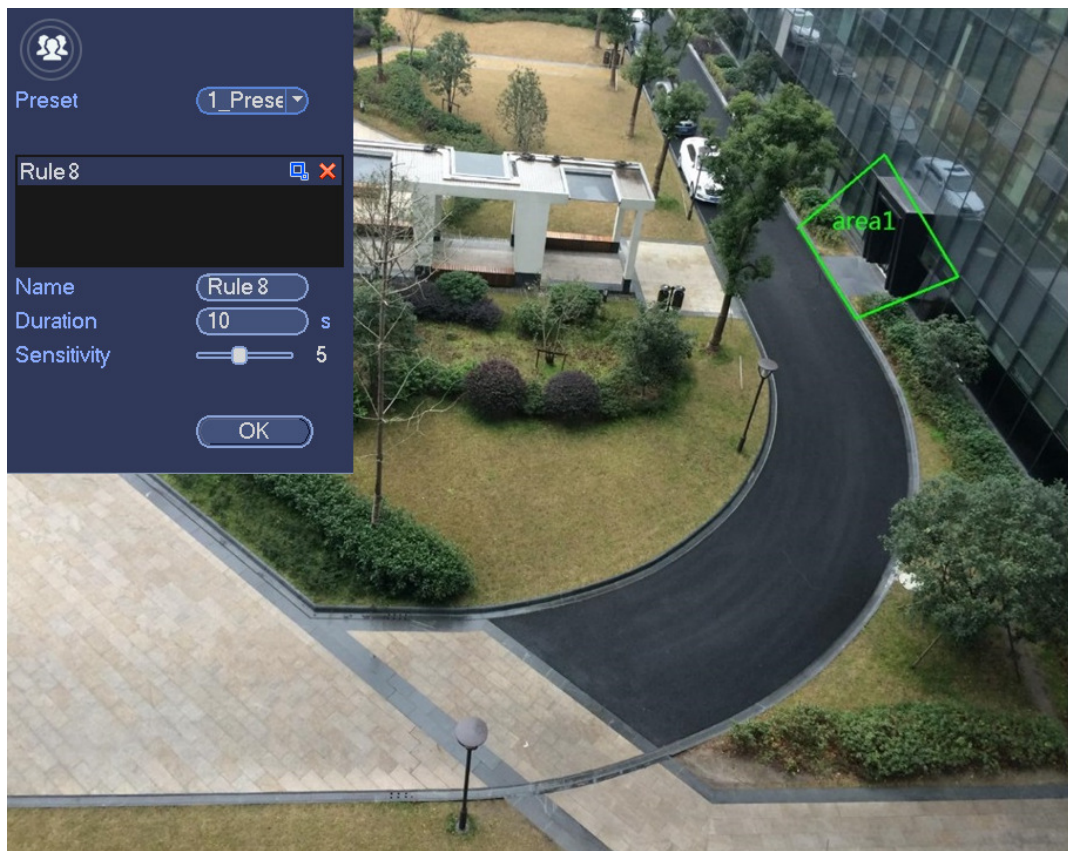



Figure 3-125

- Preset: Select a preset you want to use behavior analytics.
- Name: Input customized rule name.
- Duration: System can generate an alarm once the object is in the zone for the specified period.
- Sensitivity: It is to set alarm sensitivity. The value ranges from 1 to 10. The default setup is 5.
- Target filter: Click , user may set filter object size. Each rule can set two sizes (min size/max size). Once the object is smaller than the min size or larger than the max size, there is no alarm. Please make sure the max size is larger than the min size.

Now user may draw a rule. Left click mouse to draw a zone, until you draw a rectangle, user may right click mouse.

#### Tips

Click  to delete the corresponding rule.

Click , user may refer to the chapter 3.14.3.1 to set other parameters.

Click Apply to complete the setup.

#### 3.14.3.7 Fast moving (Optional)

It is to detect the fast moving object in the specified zone.

From main menu->Setting->Event->Behavior analytics, select the type as fast moving, the interface is shown as below. See Figure 3-126.



Figure 3-126

Click draw button  to draw the zone. See Figure 3-127.



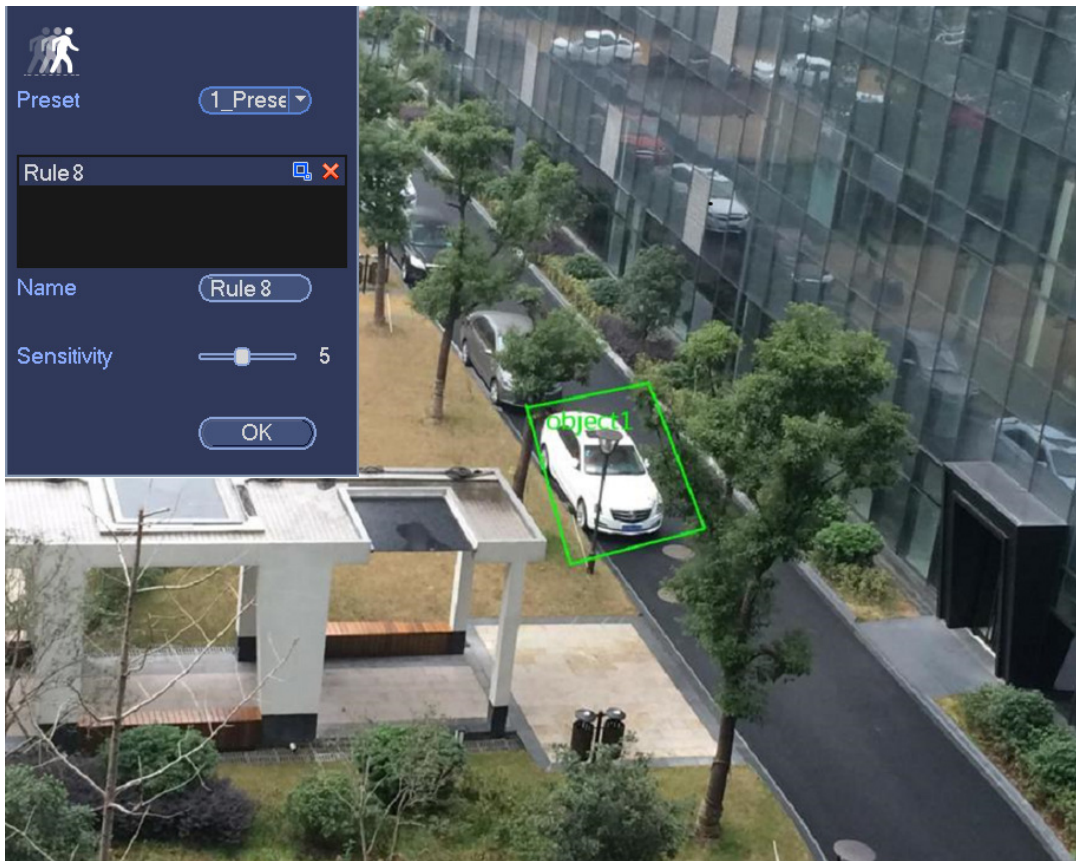



Figure 3-127

- Preset: Select a preset you want to use behavior analytics.
- Name: Input customized rule name.
- Sensitivity: It is to set alarm sensitivity. The value ranges from 1 to 10. The default setup is 5.
- Target filter: Click , user may set filter object size. Each rule can set two sizes (min size/max size). Once the object is smaller than the min size or larger than the max size, there is no alarm. Please make sure the max size is larger than the min size.

Now user may draw a rule. Left click mouse to draw a zone, until you draw a rectangle, user may right click mouse.

#### Tips

Click  to delete the corresponding rule.

Click , user may refer to the chapter 3.14.3.1 to set other parameters.

Click Apply to complete the setup.

#### 3.14.3.1 Global Setup (Optional)

After you set the rule(s), user may see the following interface. See Figure 3-128.



Figure 3-128

Click Global config button, the interface is shown as below. See Figure 3-129.

- Channel: Please select a channel from the dropdown list.
- Preset: Select a preset you want to set the rule. Please note, you need to add a preset first, otherwise, user may not see the preset dropdown list. If there is no preset, user may draw a rule in current channel.
- Calibration zone:
  - ✧ Click Add zone , user may draw a calibration zone at the left pane of the interface. Select a zone and then click Delete zone button; user may remove the selected zone.
  - ✧ Select gauge type (horizontal/tilt), user may set the corresponding length. User may draw three tilt gauges and one horizontal gauge at the left pane of the interface.
  - Select Width/Height and then click Verify, user may draw a line in the calibration zone, and then user may see its actual length.
  - Refresh preset: Click it to get the latest preset setup.

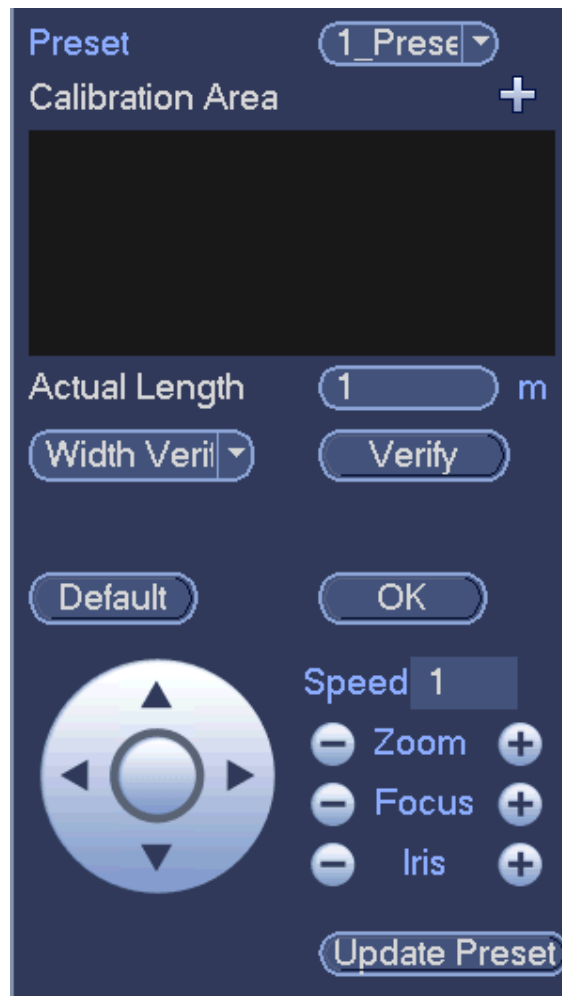

Figure 3-129

### The depth of the field calibration and principles

Here system uses one horizontal line and 3 height lines and the corresponding distance in the actual world, then it can calculate the camera internal parameters (internal geometric features and optics features) and external parameters (The 3D positions and direction in the actual world), so it can get the relative relationship between the 2D images of the camera and the 3D object of the actual world.

### Depth of the field calibration setup and notes

- Application environments
- ✧ Use the near or far scene above 3M of the camera installation position. Do not use the scene at the bottom or at the top of the video.
- ✧ The calibration is for the horizontal scene, not for tilt corner or surface.
- ✧ Do not support unusual scene such as wide angle camera or fish eye camera.
- Calibration zone setup: The calibration zone shall be in the same surface.
- Tilt calibration setup: The bottom of the three tilt gauges shall be at the same surface. They shall form a triangle and use fixed reference object as the tilt gauge such as the vehicle parking along the road, or pole. The best way is to arrange a person to stand at these three positions and draw one by one.
- Tilt gauge: Please select the reference object on the ground that you have known the length (The

sign on the road or use tools to test the actual length.)

- Since these tilt lines have the same actual length, while according to the camera modeling mode, the line at the near sight is large while the line at the far sight is small, so, when you are drawing near the camera, the line shall be longer and when you are drawing far away the camera, the line shall be short.
- Calibration verify: After you set the gauge, please use tool to check the parameters. If the verification error is huge, please adjust the setup slightly or reset to reduce the error.

### 3.14.4 Face Detect (Optional)

When camera detects human face, system can generate an alarm.

From main menu->Setting->Event->Face detect, the interface is shown as in Figure 3-130.

- Enable: Check the box to enable face detection function.
- Face ROI (Region of Interest): Check the box here, system can enhance the human face display pane.
- Log: Check the box here, system can record face detect log.

User may refer to the chapter 3.14.1.1 to set other parameters.

Click OK to complete the setup.



Figure 3-130

### 3.14.5 People Counting (Optional)

System can calculate the entry/exit people amount in the specified zone. It can generate an alarm when the amount has exceeded the threshold.

From main menu->Setting->Event->People counting, user may see an interface shown as in Figure 3-131.

- Enable: Check the box to enable people counting function.
- OSD overlay: Check the box here; user may view the people amount on the surveillance video.

- Direction: It is to set people flow direction. It includes entry/exit.
- Entry No.: It is to set people entry amount. System can generate an alarm once the amount has exceeded the threshold.
- Exit No.: It is to set people entry amount. System can generate an alarm once the amount has exceeded the threshold.
- Stranded No.: It is to set people staying amount in the zone. System can generate an alarm once the amount has exceeded the threshold.



Figure 3-131

### 3.14.6 Heat Map (Optional)

It is to detect the object activity level in the scene during the specified period.

From main menu->Setting->Event->Heat map, user may see an interface shown as in Figure 3-132.

- Channel: Please select a channel and then check the box to enable this function.
- Enable: Check the box to enable heat map function.



Figure 3-132

### 3.14.7 Audio Detect

System can generate an alarm once it detect the audio input is abnormal or audio volume changes. From main menu->Setting->Event->Audio detect, user may see an interface shown as in Figure 3-133.

- Input abnormal: Check the box here, system can generate an alarm once the audio input is abnormal.
- Intensity change: Check the box here, system can generate an alarm once the audio volume becomes strong.
- Sensitivity: It refers to the audio recognition sensitivity. The higher the value is, the higher the sensitivity is.
- Threshold: It is to set intensity change threshold. The smaller the value is, the higher the sensitivity is.
- Log: Check the box here, system can record audio detect alarm log.

User may refer to the chapter 3.14.1.1 to set other parameters.



Figure 3-133

### 3.14.8 Smart Track (Optional)

The smart track function refers to a system consisting of the fish eye and the PTZ camera. The fish eye is the master camera to view the whole surveillance situation, and the PTZ camera is the slave camera to view the details.

#### Important

The fish eye and the PTZ camera shall surveillance proper zone.

The fish eye and the PTZ camera shall use the private protocol to add.

From Main menu->Setting->Event->Smart track, user may see an interface shown as Figure 3-134.



Figure 3-134

Click add button, user may see an interface shown as in Figure 3-135.

- Type: Here user may select smart track mode. It includes: 1 fish eye+1 PTZ camera/1 fish eye+2 PTZ cameras/1 fish eye+3 PTZ cameras.
- Scene: It is the monitor position. Input customized monitor position name.
- Main channel: Click Select button and then select fish eye from the dialogue box.
- PTZ camera: Click Select button and then select corresponding PTZ camera amount from the dialogue box.





Figure 3-135

After the setup, click OK button.

In Figure 3-134, click  or double click the line, user may go to the following interface. See Figure 3-136. Here user may set the fish eye and PTZ camera bonding relationship.

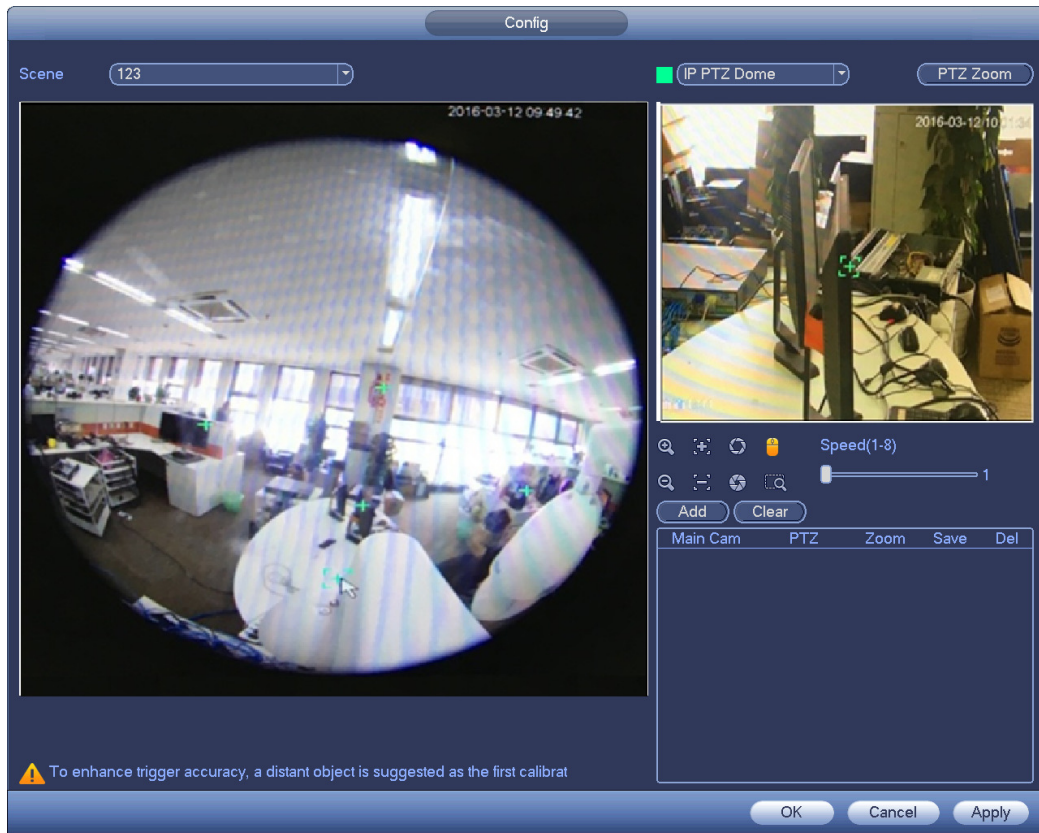









Figure 3-136

On the fish eye displayed zone, left click mouse or move  to confirm the position.

On the PTZ camera displayed zone, use the following buttons to adjust the PTZ camera position.

Button	Function
	Zoom
	Focus
	Iris
	Electronic mouse, move it on the interface to control the PTZ direction.
	It is to control PTZ movement speed. The higher the value is, the faster the speed is. For example, the step 8 speed is faster than step 1.

Click add button and then click  to save.

Now you complete one group position, user may view at the list. See Figure 3-137.



Figure 3-137

Repeat the above steps to set at least three group positions.

**Note**

- For one PTZ camera, there must be three calibration groups. System max supports 8 group positions. Please make sure the calibration position is accurate.
- For the first calibration group position, please select the reference objects at the far distance to enhance the trigger accuracy.

Click OK button to complete the calibration setup, user may go back to the smart track interface, the status is shown as

**Note**

After you complete smart track setup, please go to the preview interface and then right click mouse, and then select Smart track, user may view the corresponding video. Please refer to chapter 3.9 for detailed information.

**3.14.9 Alarm Output**

From Main menu->Setting->Event->Alarm output, user may see an interface shown as in Figure 3-138.

Here is for you to set proper alarm output (Auto/manual/stop).

Click OK button of the alarm reset, user may clear all alarm output status.



Figure 3-138

Please highlight icon  to select the corresponding alarm output.

After all the setups please click OK button, system goes back to the previous menu.

### 3.14.10 Alarm Setup

In the main menu, from Setting->Event->Alarm, user may see alarm setup interface.

- Alarm in: Here is for you to select channel number.

In the main menu, from Setting->Event->Alarm, user may see alarm setup interface. See Figure 3-139.



There are four alarm types. See Figure 3-139 to Figure 3-142.

- ◇ Local alarm: The alarm signal system detects from the alarm input port.
- ◇ Network alarm: It is the alarm signal from the network.
- ◇ IPC external alarm: It is the on-off alarm signal from the front-end device and can activate the local HNVR.
- ◇ IPC offline alarm: Once you select this item, system can generate an alarm when the front-end IPC disconnects with the local HNVR. The alarm can activate record, PTZ, snap and etc. The alarm can last until the IPC and the HNVR connection resumes.

#### Important

- **If it is your first time to boot up the device, the disconnection status of the front-end network camera will not be regarded as offline. After one successfully connection, all the disconnection events will be regarded as IPC offline event.**
- **When IPC offline alarm occurs, the record and snapshot function of digital channel is null.**
- Enable: Please you need to highlight this button to enable current function.
- Type: normal open or normal close.
- Period: Click set button, user may see an interface is shown as in Figure 3-144. There are two ways for you to set periods. There are max 6 periods in one day. There are four record types: regular, motion detection (MD), Alarm, MD & alarm.

- ◇ In Figure 3-144, Select icon  of several dates, all checked items can be edited together.

Now the icon is shown as . Click  to delete a record type from one period.

- ◇ In Figure 3-144. Click button  after one date or a holiday, user may see an interface shown as in Figure 3-145. There are four record types: regular, motion detection (MD), Alarm, MD & alarm.

- PTZ activation: When an alarm occurred, system can activate the PTZ operation. The PTZ activation lasts an anti-dither period. See Figure 3-143.
- Anti-dither: Here user may set anti-dither time. The value ranges from 5 to 600s. The anti-dither time refers to the alarm signal lasts time. It can be seem as the alarm signal activation stays such as the buzzer, tour, PTZ activation, snapshot, channel record. The stay time here does not include the latch time. During the alarm process, the alarm signal can begin an anti-dither time if system detects the local alarm again. The screen prompt, alarm upload, email and etc will not be activated. For example, if you set the anti-dither time as 10 second, user may see the each activation may last 10s if the local alarm is activated. During the process, if system detects another local alarm signal at the fifth second, the buzzer, tour, PTZ activation, snapshot, record channel will begin another 10s while the

screen prompt, alarm upload, email will not be activated again. After 10s, if system detects another alarm signal, it can generate an alarm since the anti-dither time is out.

- Alarm output: The number here is the device alarm output port. User may select the corresponding ports(s) so that system can activate the corresponding alarm device(s) when an alarm occurred.
- Latch: When the anti-dither time ended, the channel alarm you select in the alarm output may last the specified period. The value ranges from 1 to 300 seconds. This function is not for other alarm activation operations. The latch is still valid even you disable the alarm event function directly.
- Show message: System can pop up a message to alarm you in the local host screen if you enabled this function.
- Alarm upload: System can upload the alarm signal to the network (including alarm centre and the WEB) if you enabled current function. System only uploads the alarm channel status. User may go to the WEB and then go to the Alarm interface to set alarm event and alarm operation. Please go to the Network interface to set alarm centre information.
- Send email: System can send out the alarm signal via the email to alert you when an alarm occurs. Once you enable the snap function, system can also send out an image as the attachment. Please go to the Main Menu->Setting ->Network->Email interface to set.
- Record channel: user may select proper channel to record alarm video (Multiple choices).
  - ◇ You need to set alarm record mode as Schedule in Record interface (Main Menu->Advanced->Record). Please note the manual record has the highest priority. System record all the time no matter there is an alarm or not if you select Manual mode.
  - ◇ Now user may go to the Schedule interface (Main Menu->Setting->Schedule) to set the record type, corresponding channel number, week and date. User may select the record type: Regular/MD/Alarm/MD&Alarm. Please note, user may not select the MD&Alarm and MD(or Alarm) at the same time.
  - ◇ Now user may go to the Encode interface to select the alarm record and set the encode parameter (Main Menu->Setting->Encode).
  - ◇ Finally, user may set the alarm input as the local alarm and then select the record channel. The select channel begins alarm record when an alarm occurred. Please note system begins the alarm record instead of the MD record if the local alarm and MD event occurred at the same time.
- Tour: Here user may enable tour function when an alarm occurs. System supports 1/8-window tour. Please go to chapter3.6.4.1 Display for tour interval setup. Please note the tour setup here has higher priority than the tour setup you set in the Display interface. Once there two tours are both enabled, system can enable the alarm tour as you set here when an alarm occurred. If there is no alarm, system implements the tour setup in the Display interface.
- Snapshot: User may enable this function to snapshot image when an alarm occurs.
- Log: Check the box here, system can record local alarm log.
- Buzzer: Highlight the icon to enable this function. The buzzer beeps when an alarm occurs.



Figure 3-139



Figure 3-140



Figure 3-141

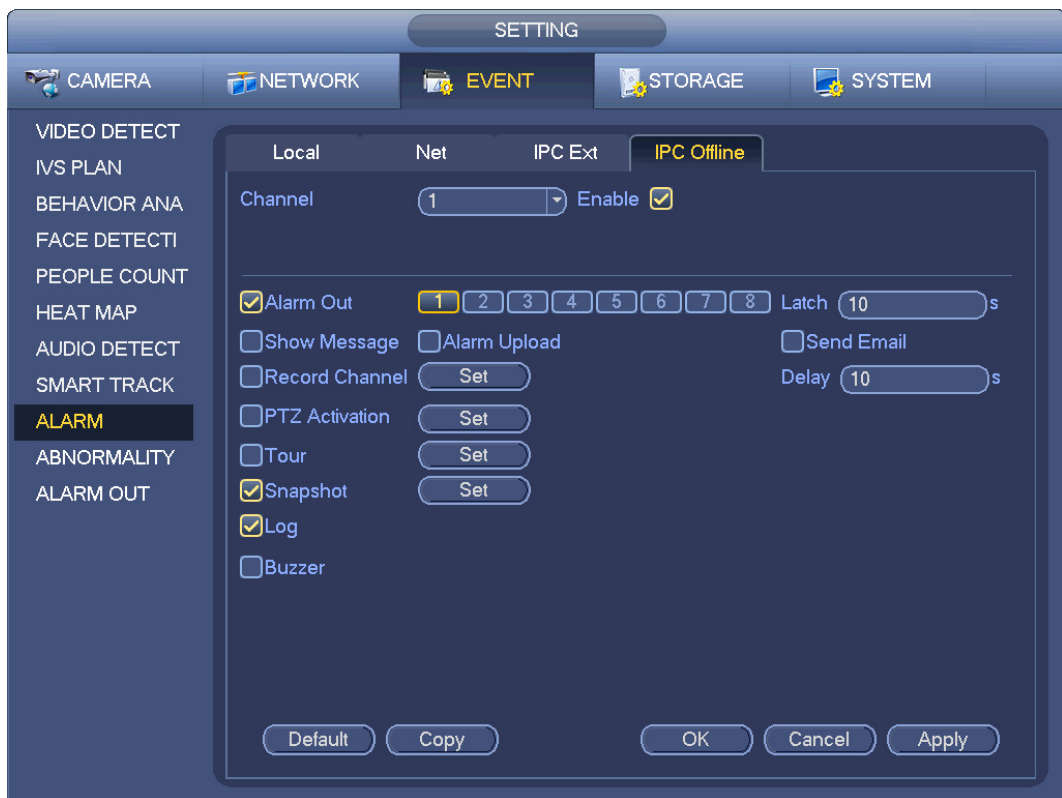

Figure 3-142



Figure 3-143

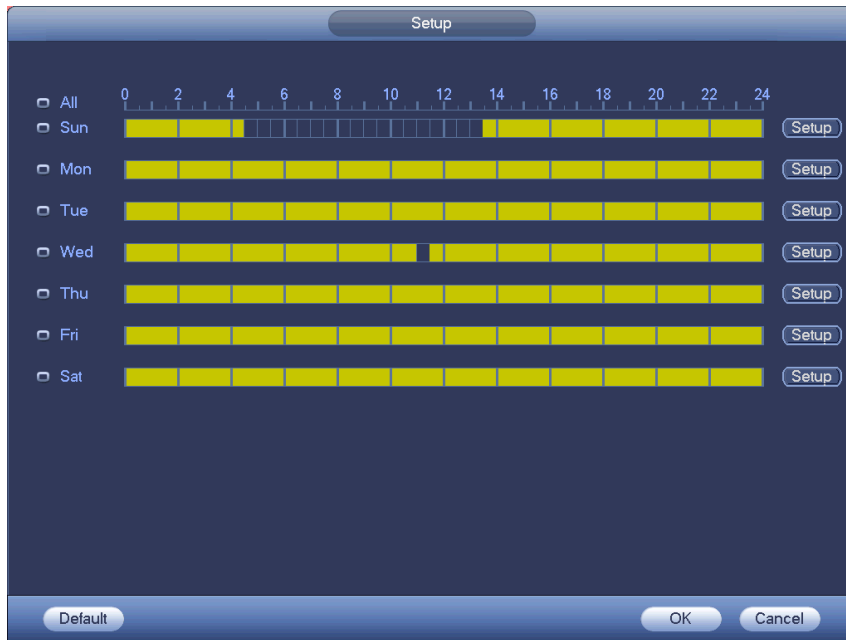



Figure 3-144





Figure 3-145

Please highlight icon  to select the corresponding function. After setting all the setups please click save button, system goes back to the previous menu.

### 3.14.11 Abnormality

There are three types: Disk/Network/power fault.

- ✧ Disk: Disk error, no disk, no space. See Figure 3-146.
  - ✧ Network: Disconnection, IP conflict, MAC conflict. See Figure 3-147.
  - ✧ Power fault. The interface is shown as in Figure 3-148. This function is for power-redundancy series product. When this function is on, user may remove one power sourcing from the system, it does not affect the normal operation of the device, but system will generate an alarm to alert you.
- Alarm output: Please select alarm activation output port (multiple choices).
  - Less than: System can alarm you when the HDD space is less than the threshold you set here (For HDD no space type only).
  - Latch: Here user may set corresponding delaying time. The value ranges from 1s-300s. System automatically delays specified seconds in turning off alarm and activated output after external alarm cancelled.
  - Show message: system can pop up the message in the local screen to alert you when an alarm occurs.
  - Alarm upload: System can upload the alarm signal to the network (including alarm centre) if you enabled current function. For disconnection event, IP conflict event and MAC conflict event, this function is null.
  - Send email: System can send out email to alert you when an alarm occurs.
  - Buzzer: Highlight the icon to enable this function. The buzzer beeps when an alarm occurs.
  - Log: Check the box here, system can record corresponding alarm log.



Figure 3-146



Figure 3-147



Figure 3-148

## 3.15 Network

### 3.15.1 Network Settings

#### 3.15.1.1 TCP/IP

From main menu->Setting->Network->TCP/IP, the interface is shown as in Figure 3-149.

- IP Version: There are two options: IPv4 and IPv6. Right now, system supports these two IP address format and user may access via them.
- Preferred DNS server: DNS server IP address.
- Alternate DNS server: DNS server alternate address.
- Default card: It is to set default network card.
- LAN download: System can process the downloaded data first if you enable this function. The download speed is 1.5X or 2.0X of the normal speed.

#### Important

**For the IP address of IPv6 version, default gateway, preferred DNS and alternate DNS, the input value shall be 128-digit. It shall not be left in blank.**



Figure 3-149

Click Edit button , user may go to the following interface. See Figure 3-150.

- Network mode:
  - ✧ Single NIC: eth1/eth2/ eth3/eth4 operate separately. User may use the services such as HTTP, RTP service via eth1/eth2/ eth3/eth4. Usually you need to set one default card (default setup is eth1) to request the auto network service from the device-end such as DHCP, email, FTP and etc. In multiple-address mode, system network status is shown as offline once one card is offline.
  - ✧ Network fault-tolerance: In this mode, device uses bond0 to communicate with the external devices. User may focus on one host IP address. At the same time, you need to set one master card. Usually there is only one running card (master card).System can enable alternate card when the master card is malfunction. The system is shown as offline once these two cards are both offline.
  - ✧ Load balance: In this mode, device uses bond0 to communicate with the external device. The eth1/eth2/ eth3/eth4 are working now and bearing the network load. Their network load are general the same. The system is shown as offline once all cards are offline.
  - ✧ **Note:** Different series products have different Ethernet port amount.
- NIC member: User may check the box here to select the bind cards.
  - ✧ This mode is for fault-tolerance or load balance mode only.
  - ✧ The network cards number shall be equal to or more than 2.
  - ✧ The different types of cards such as fiber card or the Ethernet card can not binding together.
- IP Version: There are two options: IPv4 and IPv6. Right now, system supports these two IP address format and user may access via them.

- MAC address: The host in the LAN can get a unique MAC address. It is for you to access in the LAN. It is read-only.
- IP address: Here user may use up/down button (▲▼) or input the corresponding number to input IP address. Then user may set the corresponding subnet mask the default gateway.
- Default gateway: Here user may input the default gateway. Please note system needs to check the validity of all IPv6 addresses. The IP address and the default gateway shall be in the same IP section. That is to say, the specified length of the subnet prefix shall have the same string.
- DHCP: It is to auto search IP. When enable DHCP function, user may not modify IP/Subnet mask /Gateway. These values are from DHCP function. If you have not enabled DHCP function, IP/Subnet mask/Gateway display as zero. You need to disable DHCP function to view current IP information. Besides, when PPPoE is operating, user may not modify IP/Subnet mask /Gateway.
- MTU: It is to set MTU value of the network adapter. The value ranges from 1280-7200 bytes. The default setup is 1500 bytes. Please note MTU modification may result in network adapter reboot and network becomes off. That is to say, MTU modification can affect current network service. System may pop up dialog box for you to confirm setup when you want to change MTU setup. Click OK button to confirm current reboot, or user may click Cancel button to terminate current modification. Before the modification, user may check the MTU of the gateway; the MTU of the NVR shall be the same as or is lower than the MTU of the gateway. In this way, user may reduce packets and enhance network transmission efficiency. Right now, the value here is for read-only.

The following MTU value is for reference only.

- ◇ 1500: Ethernet information packet max value and it is also the default value. It is the typical setup when there is no PPPoE or VPN. It is the default setup of some router, switch or the network adapter.
- ◇ 1492: Recommend value for PPPoE.
- ◇ 1468: Recommend value for DHCP.

After completing all the setups please click OK button.

### Tips

Click button  to cancel card binding.

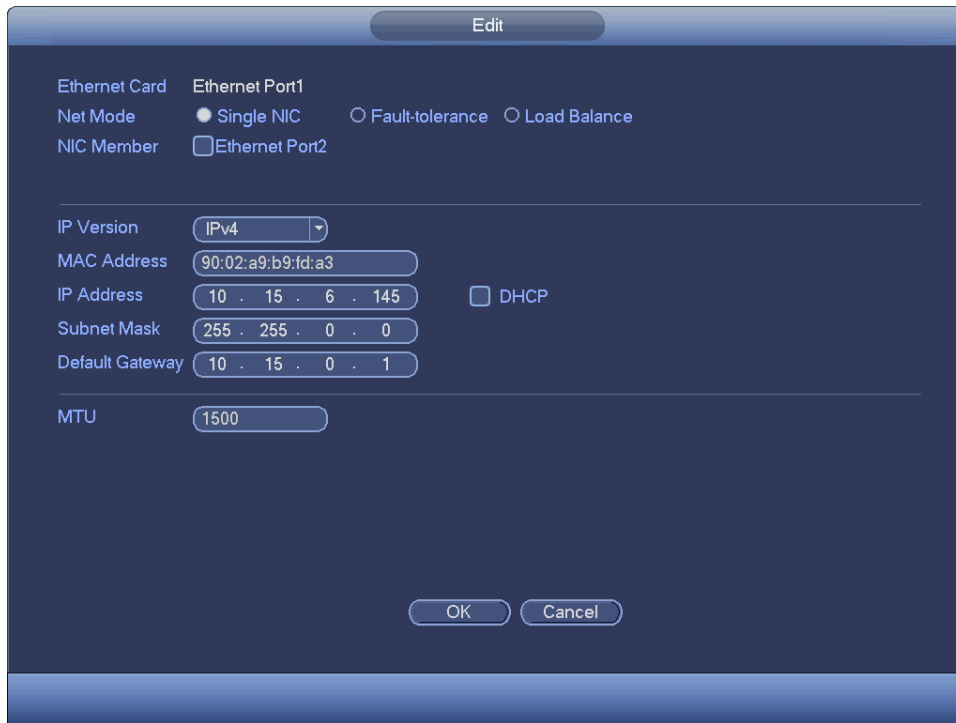

Figure 3-150

### 3.15.1.2 Port

The port setup interface is shown as in Figure 3-151.

- Max connection: system support maximal 128 users. 0 means there is no connection limit.
- TCP port: Default value is 37777.
- UDP port: Default value is 37778.
- HTTP port: Default value is 80.
- HTTPS port: Default value is 443.
- RTSP port: Default value is 554.

**Important: System needs to reboot after you changed and saved any setup of the above four ports. Please make sure the port values here do not conflict.**



Figure 3-151

### 3.15.1.3 PPPoE

PPPoE interface is shown as in Figure 3-152.

Input "PPPoE name" and "PPPoE password" you get from your ISP (Internet service provider).

Click save button, you need to restart to activate your configuration.

After rebooting, NVR will connect to internet automatically. The IP in the PPPoE is the NVR dynamic value. User may access this IP to visit the unit.



Figure 3-152

#### 3.15.1.4 DDNS

DDNS setup interface is shown as in Figure 3-153.

You need a PC of fixed IP in the internet and there is the DDNS software running in this PC. In other words, this PC is a DNS (domain name server).

In network DDNS, please select DDNS type and highlight enable item. And then please input your PPPoE name you get from you IPS and server IP (PC with DDNS). Click save button and then reboot system.

Click save button, system prompts for rebooting to get all setup activated.

After rebooting, open IE and input as below:

http: //(DDNS server IP)/(virtual directory name)/webtest.htm

e.g.: http: //10.6.2.85/DVR \_DDNS/webtest.htm.)

Now user may open DDNSServer web search page.





Figure 3-153

Please note DDNS type includes: CN99 DDNS, NO-IP DDNS, Quick DDNS, DynDNS DDNS and sysDNS DDNS. All the DDNS can be valid at the same time, user may select as you requirement. Private DDNS function shall work with special DDNS server and special Professional Surveillance Software (PSS).

### Quick DDNS and Client-end Introduction

#### 1) Background Introduction

Device IP is not fixed if you use ADSL to login the network. The DDNS function allows you to access the NVR via the registered domain name. Besides the general DDNS, the Quick DDNS works with the device from the manufacturer so that it can add the extension function.

#### 2) Function Introduction

The quick DDNS client has the same function as other DDNS client end. It realizes the bonding of the domain name and the IP address. Right now, current DDNS server is for our own devices only. You need to refresh the bonding relationship of the domain and the IP regularly. There is no user name, password or the ID registration on the server. At the same time, each device has a default domain name (Generated by MAC address) for your option. User may also use customized valid domain name (has not registered.).

#### 3) Operation

Before you use Quick DDNS, you need to enable this service and set proper server address, port value and domain name.

- Server address: www.quickddns.com
- Port number: 80
- Domain name: There are two modes: Default domain name and customized domain name.

Except default domain name registration, user may also use customized domain name (User may input your self-defined domain name.) After successful registration, user may use domain name to login installed of the device IP.

- User name: It is optional. User may input your commonly used email address.

**Important**

- Do not register frequently. The interval between two registrations shall be more than 60 seconds. Too many registration requests may result in server attack.
- System may take back the domain name that is idle for one year. User may get a notification email before the cancel operation if your email address setup is OK.

3.15.1.5 UPnP

The UPNP protocol is to establish a mapping relationship between the LAN and the WAN. Please input the router IP address in the LAN in Figure 3-149. See Figure 3-154.

- UPNP on/off : Turn on or off the UPNP function of the device.
- Status: When the UPNP is offline, it shows as “Unknown”. When the UPNP works it shows “Success”
- Router LAN IP: It is the router IP in the LAN.
- WAN IP: It is the router IP in the WAN.
- Port Mapping list: The port mapping list here is the one to one relationship with the router’s port mapping setting.
- List:
  - ◇ Service name: Defined by user.
  - ◇ Protocol: Protocol type
  - ◇ Internal port: Port that has been mapped in the router.
  - ◇ External port: Port that has been mapped locally.
- Default: UPNP default port setting is the HTTP, TCP and UDP of the NVR.
- Add to the list: Click it to add the mapping relationship.
- Delete: Click it to remove one mapping item.

Double click one item; user may change the corresponding mapping information. See Figure 3-155.

**Important:**

**When you are setting the router external port, please use 1024~5000 port. Do not use well-known port 1~255 and the system port 256~1023 to avoid conflict.**

**For the TCP and UDP, please make sure the internal port and external port are the same to guarantee the proper data transmission.**



Figure 3-154



Figure 3-155

### 3.15.1.6 IP Filter

IP filter interface is shown as in Figure 3-156. User may add IP in the following list. The list supports max 64 IP addresses. System supports valid address of IPv4 and IPv6. **Please note system needs to check the validity of all IPv6 addresses and implement optimization.**

After you enabled trusted sites function, only the IP listed below can access current NVR.

If you enable blocked sites function, the following listed IP addresses can not access current NVR.

- Enable: Highlight the box here, user may check the trusted site function and blocked sites function. User may not see these two modes if the Enable button is grey.
- Type: User may select trusted site and blacklist from the dropdown list. User may view the IP address on the following column.
- Start address/end address: Select one type from the dropdown list, user may input IP address in the start address and end address. Now user may click Add IP address or Add IP section to add.
  - a) For the newly added IP address, it is in enable status by default. Remove the  before the item, and then current item is not in the list.
  - b) System max supports 64 items.
  - c) Address column supports IPv4 or IPv6 format. If it is IPv6 address, system can optimize it. For example, system can optimize aa:0000:00:00aa:00aa:00aa:00aa:00aa as aa::aa:aa:aa:aa:aa:aa.
  - d) System automatically removes space if there is any space before or after the newly added IP address.
  - e) System only checks start address if you add IP address. System check start address and end address if you add IP section and the end address shall be larger than the start address.
  - f) System may check newly added IP address exists or not. System does not add if input IP address does not exist.
- Delete: Click it to remove specified item.
- Edit: Click it to edit start address and end address. See Figure 3-157. System can check the IP address validity after the edit operation and implement IPv6 optimization.
- Default: Click it to restore default setup. In this case, the trusted sites and blocked sites are both null.

**Note:**

- If you enabled trusted sites, only the IP in the trusted sites list can access the device.
- If you enabled blocked sites, the IP in the blocked sites can not access the device.
- System supports add MAC address.

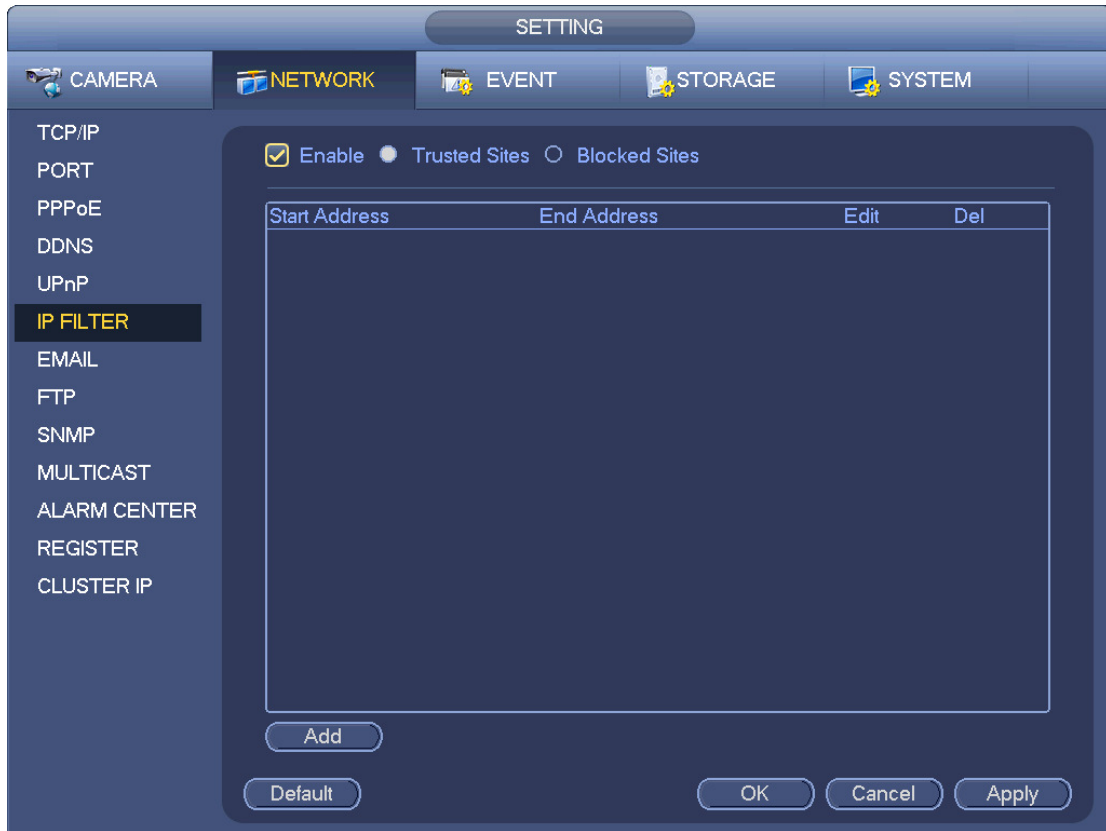

Figure 3-156

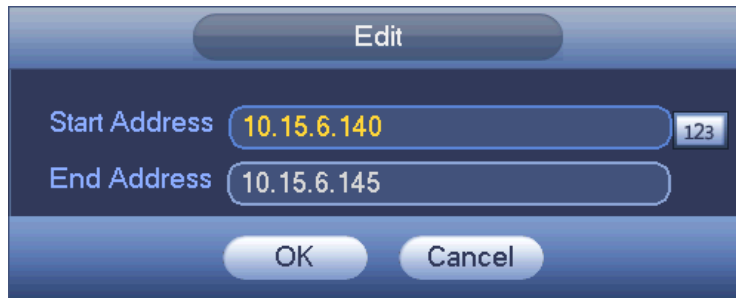

Figure 3-157

### 3.15.1.7 Email

The email interface is shown as below. See Figure 3-158.

- SMTP server: Please input your email SMTP server IP here.
- Port: Please input corresponding port value here.
- User name: Please input the user name to login the sender email box.
- Password: Please input the corresponding password here.
- Sender: Please input sender email box here.
- Title: Please input email subject here. System support English character and Arabic number. Max 32-digit.
- Receiver: Please input receiver email address here. System max supports 3 email boxes. System automatically filters same addresses if you input one receiver repeatedly.

- SSL enable: System supports SSL encryption box.
- Interval: The send interval ranges from 0 to 3600 seconds. 0 means there is no interval.
- Health email enable: Please check the box here to enable this function. This function allows the system to send out the test email to check the connection is OK or not.
- Interval: Please check the above box to enable this function and then set the corresponding interval. System can send out the email regularly as you set here. Click the Test button, user may see the corresponding dialogue box to see the email connection is OK or not.

Please note system will not send out the email immediately when the alarm occurs. When the alarm, motion detection or the abnormality event activates the email, system sends out the email according to the interval you specified here. This function is very useful when there are too many emails activated by the abnormality events, which may result in heavy load for the email server.



Figure 3-158

### 3.15.1.8 FTP

You need to download or buy FTP service tool (such as Ser-U FTP SERVER) to establish FTP service. Please install Ser-U FTP SERVER first. From “start” -> “program” -> Serv-U FTP Server -> Serv-U Administrator. Now user may set user password and FTP folder. Please note you need to grant write right to FTP upload user. See Figure 3-159.

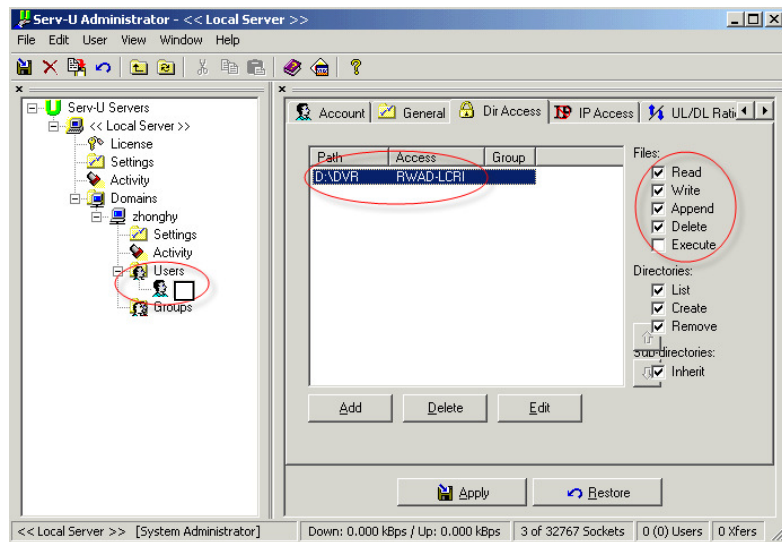

Figure 3-159

User may use a PC or FTP login tool to test setup is right or not.

For example, user may login user [FTP://10.10.7.7](ftp://10.10.7.7) and then test it can modify or delete folder or not. See Figure 3-160.

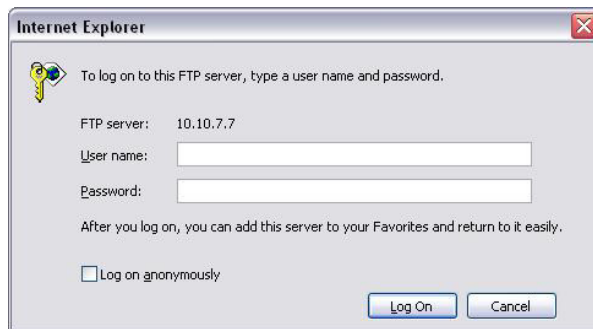



Figure 3-160

System also supports upload multiple NVRs to one FTP server. User may create multiple folders under this FTP.

FTP interface is shown as in Figure 3-161.

Please highlight the icon  in front of Enable to activate FTP function.

Here user may input FTP server address, port and remote directory. When remote directory is null, system automatically create folders according to the IP, time and channel.

User name and password is the account information for you to login the FTP.

File length is upload file length. When setup is larger than the actual file length, system will upload the whole file. When setup here is smaller than the actual file length, system only uploads the set length and auto ignore the left section. When interval value is 0, system uploads all corresponding files.

After completed channel and weekday setup, user may set two periods for one each channel.

Click the Test button, user may see the corresponding dialogue box to see the FTP connection is OK or not.



Figure 3-161

### 3.15.1.9 SNMP

SNMP is an abbreviation of Simple Network Management Protocol. It provides the basic network management frame of the network management system. The SNMP widely used in many environments. It is used in many network device, software and system.

User may set in the following interface. See Figure 3-162.





Figure 3-162

Please enable the SNMP function. Use the corresponding software tool (MIB Builder and MG-SOFT MIB Browser). You still need two MIB file: BASE-SNMP-MIB, NVR-SNMP-MIB) to connect to the device. User may get the device corresponding configuration information after successfully connection.

Please follow the steps listed below to configure.

- In Figure 3-162, check the box to enable the SNMP function. Input the IP address of the PC than is running the software in the Trap address. User may use default setup for the rest items.
- Compile the above mentioned two MIB file via the software MIB Builder.
- Run MG-SOFT MIB Browser to load the file from the previous step to the software.
- Input the device IP you want to manage in the MG-SOFT MIB Browser. Please set the corresponding version for your future reference.
- Open the tree list on the MG-SOFT MIB Browser; user may get the device configuration. Here user may see the device has how many video channels, audio channels, application version and etc.

**Note**

**Port conflict occurs when SNMP port and Trap port are the same.**

3.15.1.10 Multicast

Multicast setup interface is shown as in Figure 3-163.



Figure 3-163

Here user may set a multiple cast group. Please refer to the following sheet for detailed information.

- IP multiple cast group address
  - 224.0.0.0-239.255.255.255
  - “D” address space
    - The higher four-bit of the first byte=“1110”
- Reserved local multiple cast group address
  - 224.0.0.0-224.0.0.255
  - TTL=1 When sending out telegraph
  - For example
    - 224.0.0.1 All systems in the sub-net
    - 224.0.0.2 All routers in the sub-net
    - 224.0.0.4 DVMRP router
    - 224.0.0.5 OSPF router
    - 224.0.0.13 PIMv2 router
- Administrative scoped addressees
  - 239.0.0.0-239.255.255.255
  - Private address space
    - Like the single broadcast address of RFC1918
    - Can not be used in Internet transmission
    - Used for multiple cast broadcast in limited space.

Except the above mentioned addresses of special meaning, user may use other addresses. For example:

Multiple cast IP: 235.8.8.36

Multiple cast PORT: 3666.

After you logged in the Web, the Web can automatically get multiple cast address and add it to the multiple cast groups. User may enable real-time monitor function to view the view.  
Please note multiple cast function applies to special series only.

### 3.15.1.11 Alarm Centre

This interface is reserved for you to develop. See Figure 3-164.



Figure 3-164

### 3.15.1.12 Auto register

This function allows the device to auto register to the proxy you specified. In this way, user may use the client-end to access the NVR and etc via the proxy. Here the proxy has a switch function. In the network service, device supports the server address of IPv4 or domain.

Please follow the steps listed below to use this function.

Please set proxy server address, port, and sub-device name at the device-end. Please enable the auto register function, the device can auto register to the proxy server.

1) The setup interface is shown as in Figure 3-165.

#### **Important**

Do not input network default port such as TCP port number.



Figure 3-165

2) The proxy server software developed from the SDK. Please open the software and input the global setup. Please make sure the auto connection port here is the same as the port you set in the previous step.

3) Now user may add device. Please do not input default port number such as the TCP port in the mapping port number. The device ID here shall be the same with the ID you input in Figure 3-165. Click Add button to complete the setup.

4) Now user may boot up the proxy server. When you see the network status is Y, it means your registration is OK. User may view the proxy server when the device is online.

### **Important**

The server IP address can also be domain. But you need to register a domain name before you run proxy device server.

#### 3.15.1.13 Cluster IP

About Cluster service: when master device is malfunction, the slave device can use the master device configuration and virtual IP address to replace the work (monitor or record) accordingly. When you use the virtual IP to access the device, he can still view the real-time video and there is no risk of record loss. Once the master device becomes properly, the slave can still work until you use the WEB to fix manually. During the whole process (the master device is working properly->master device is malfunction->master device becomes work properly again), user may use this virtual IP to access the device all the time.

It is for you to set IP address, subnet mask, gateway and etc of the Switch. See Figure 3-166.

Please check the box to enable this function and then input corresponding IP address, subnet mask, default gateway. Click OK button to complete the setup. The virtual IP here is for the master device.

### **Note**

The IP in the TCP/IP interface is for cluster internal control (It is mainly for the mater device and slave device internal interactive). The virtual IP you set here is for cluster external control (It is for external network connection).



Figure 3-166

### 3.15.2 Network Test

In this interface, user may see network test and network load information.

#### 3.15.2.1 Network Test

From main menu->Info-Network->Test, the network test interface is shown as in Figure 3-167.

- Destination IP: Please input valid IPV4 address and domain name.
- Test: Click it to test the connection with the destination IP address. The test results can display average delay and packet loss rate and user may also view the network status as OK, bad, no connection and etc.
- Network Sniffer backup: Please insert USB2.0 device and click the Refresh button, user may view the device on the following column. User may use the dropdown list to select peripheral device. Click Browse button to select the snap path. The steps here are same as preview backup operation.

User may view all connected network adapter names (including Ethernet, PPPoE, WIFI, and 3G), user may click the button  on the right panel to begin Sniffer. Click the grey stop button to stop. Please note system can not Sniffer several network adapters at the same time.

After Sniffer began, user may exit to implement corresponding network operation such as login WEB, monitor. Please go back to Sniffer interface to click  stop Sniffer. System can save the packets to the

specified path. The file is named after “Network adapter name+time”. User may use software such as Wireshark to open the packets on the PC for the professional engineer to solve complicated problems.

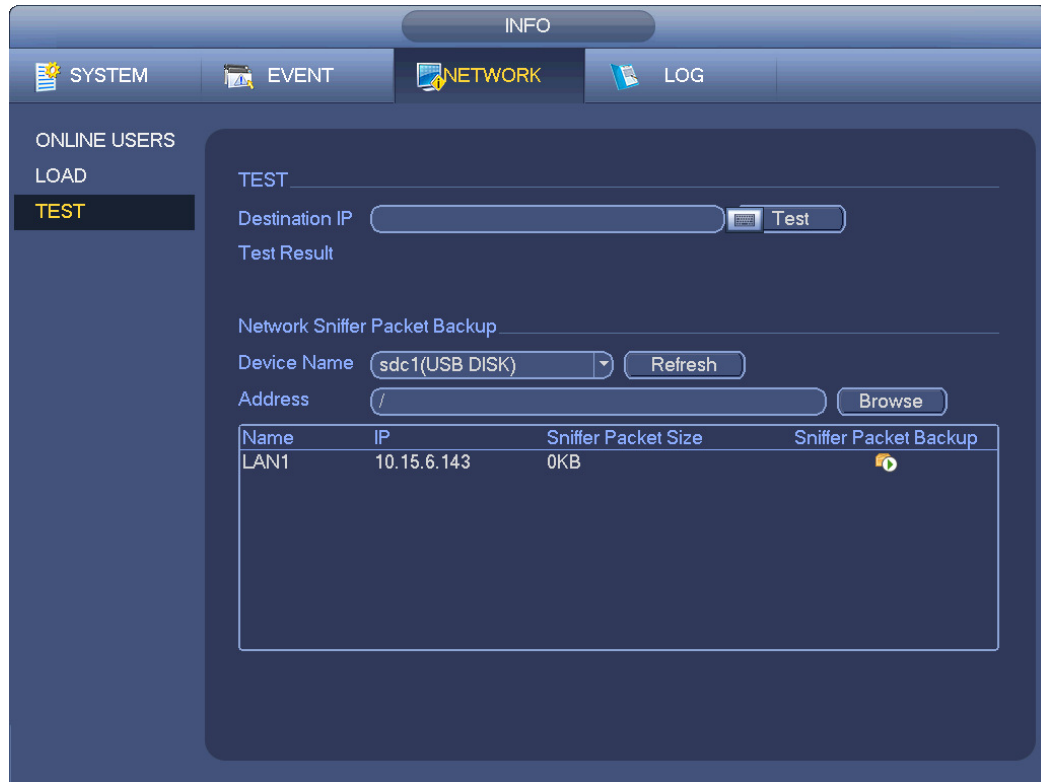

Figure 3-167

### 3.15.2.2 Network Load

From main menu->Info->Network->Load, network load is shown as in Figure 3-168. Here user may view the follow statistics of the device network adapter.

Here user may view information of all connected network adapters. The connection status is shown as offline if connection is disconnected. Click one network adapter, user may view the flow statistics such as send rate and receive rate at the top panel



Figure 3-168

### 3.16 HDD Setup

Here user may view HDD information such as type, status, total capacity, record time and etc. The operation includes format, resume from error, change HDD property (Read write, Read-only). Here user may also set alarm and HDD storage position.

#### 3.16.1 Format

- From Main menu->Setting->Storage->HDD Manager, user may go to HDD management interface. See Figure 3-169.

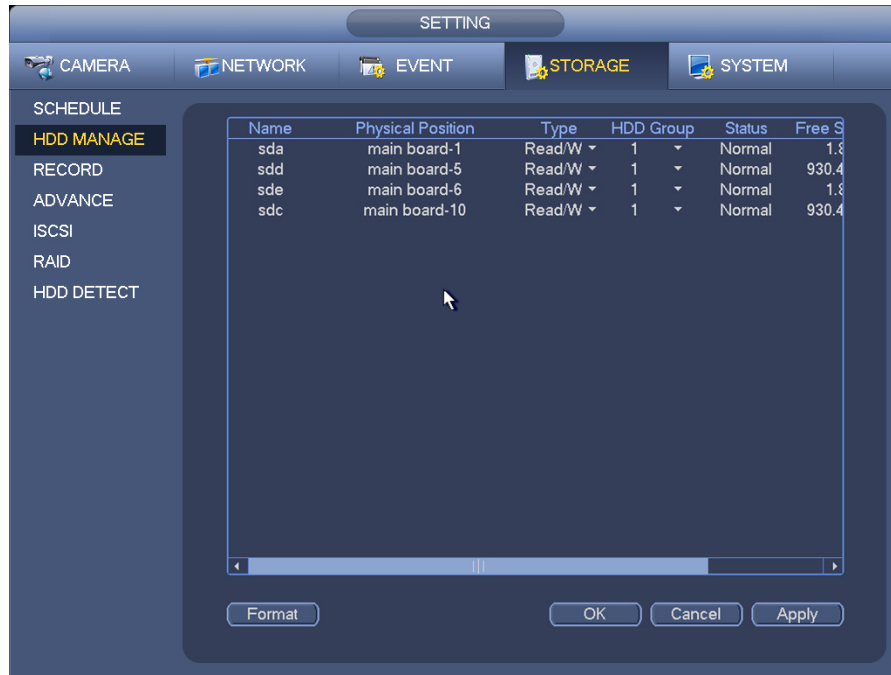

Figure 3-169

b) Select a HDD and then select format from the dropdown list. Click Execute button.

c) Click OK button to complete the setup. User may see system needs to restart to activate current setup.

### 3.16.2 HDD Information

From Main menu->Info ->System->HDD, here is to list hard disk type, total space, free space, and status. See Figure 3-170.

o means current HDD is normal.. - means there is no HDD.

If disk is damaged, system shows as "?". Please remove the broken hard disk before you add a new one.

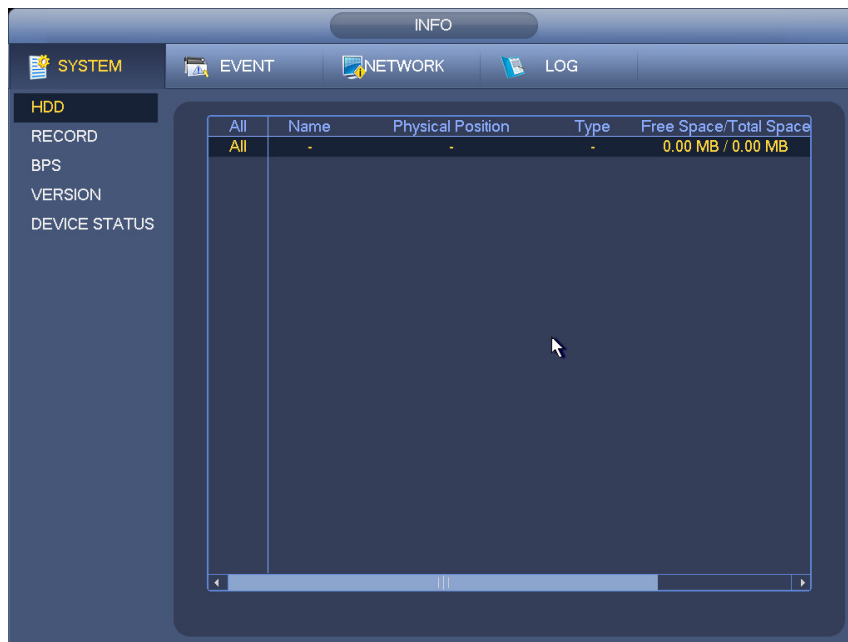



Figure 3-170

In Figure 3-170, click one HDD item, the S.M.A.R.T interface is shown as in Figure 3-171.



Figure 3-171

Parameter	Function
SATA	1 here means there is 1 HDD. For different series product, the max HDD amount may vary, When HDD is working properly, system is shown as O. . “_” means there is no HDD.
SN	User may view the HDD amount the device connected to; * means the second HDD is current working HDD.
Type	The corresponding HDD property.
Total space	The HDD total capacity.
Free space	The HDD free capacity.
Status	HDD can work properly or not.
Bad track	Display there is bad track or not.
Page up	Click it to view previous page.
Page down	Click it to view the next page.
View recording time	Click it to view HDD record information (file start time and end time).

View HDD type and capability	Click it to view HDD property, status and etc,
------------------------------	--

### 3.16.3 Advanced

From Main menu->Setting->Storage->Advanced, It is to set HDD group, and HDD group setup for main stream, sub stream and snapshot operation

Click main stream/sub stream/snapshot button to set corresponding HDD group information. See Figure 3-172 through Figure 3-174.



Figure 3-172



Figure 3-173



Figure 3-174

### 3.16.4 iSCSI

#### iSCSI function is for some series product only.

User may set the network mapping HDD so that device can store audio/video on the network HDD.

From Main menu->Setting->Storage->iSCSI, user may go to the following interface. See Figure 3-175.

- Server IP address: It is to input iSCSI server IP address.
- Port: It is to input iSCSI server port value. The default setup is 3260.
- User name/password: It is to input iSCSI server user name and password. Check the Anonymous button if it supports anonymous login.
- Set path: User may click the Set path button to select the remote storage path. Please note each path here stands for one iSCSI share disk. The path has been generated when it is created at the server.
- Add: After you input the above information, click add button to add the new information to the list.

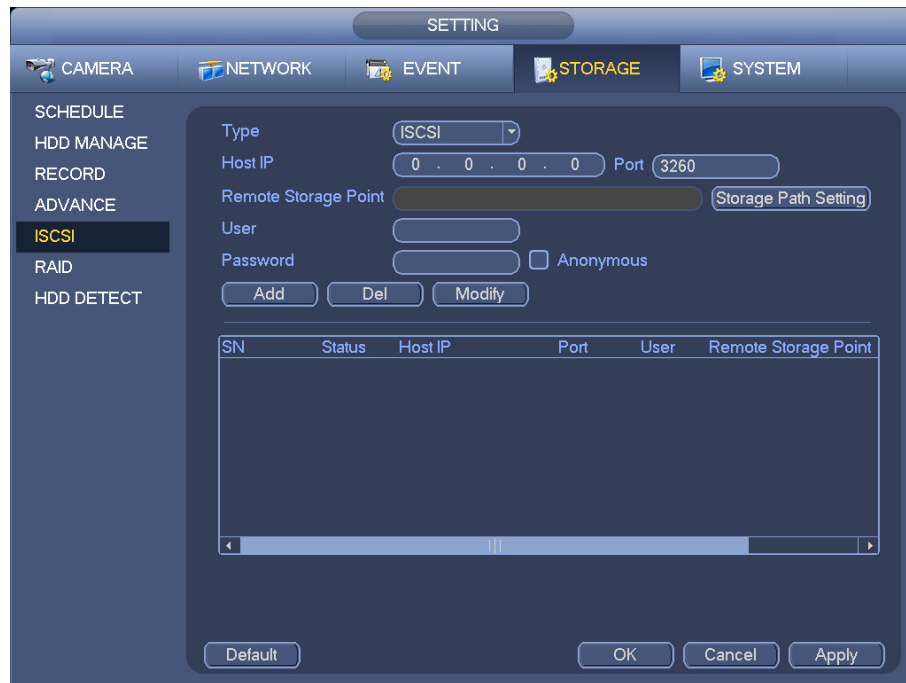

Figure 3-175

Click Ok button to complete the setup.

#### Tips

Click the modify/delete button to change or remove the iSCSI disk.

Now, from the main menu->setting->Storage-> HDD manage, user may see the corresponding interface.

### 3.16.5 RAID

#### Important

**Please make sure your purchased product support the RAID function, otherwise user may not see the following interface.**

**Right now, RAID supports Raid0, Raid1, Raid5, Raid6, and Raid10. Local hotspare supports Raid1, Raid5, Raid6, and Raid10.**

#### 3.16.5.1 RAID Config

From Main menu->Setting->Storage->RAID->RAID Config, it is for you to manage RAID HDD. It can display RAID name, type, free space, total space, status and etc. Here user may add/delete RAID HDD.

Click Add button to select RAID type and then select HDDs, click OK button to add. See Figure 3-176.

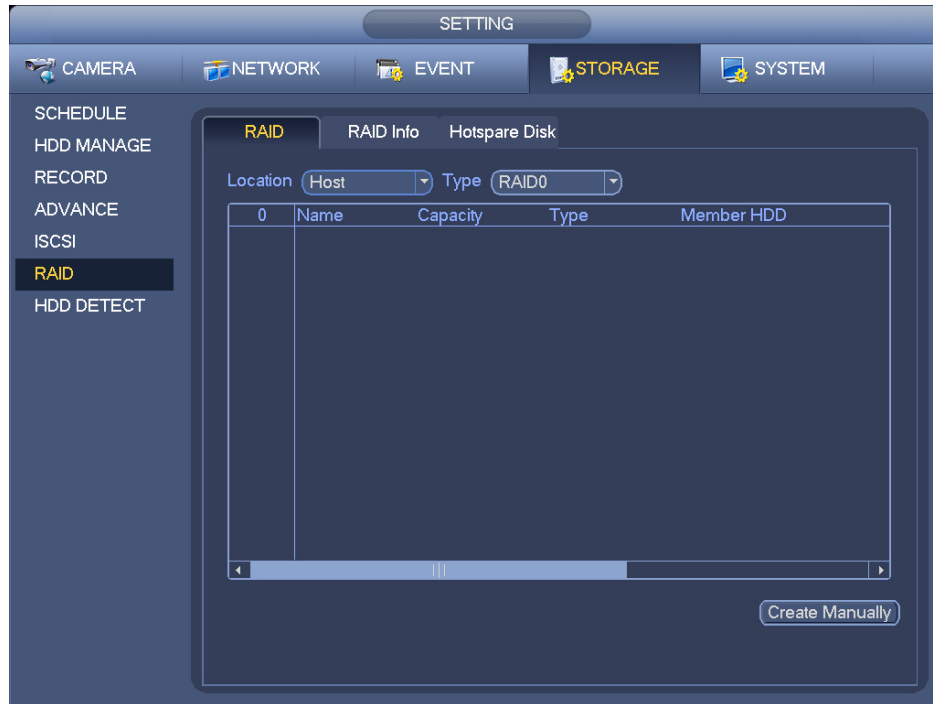

Figure 3-176

### 3.16.5.2 RAID Info

From Main menu->Setting->Storage->RAID->RAID info, it is to display RAID name, space, type, member HDD, hotspare HDD, status and etc. Here user may delete RAID. See Figure 3-177.

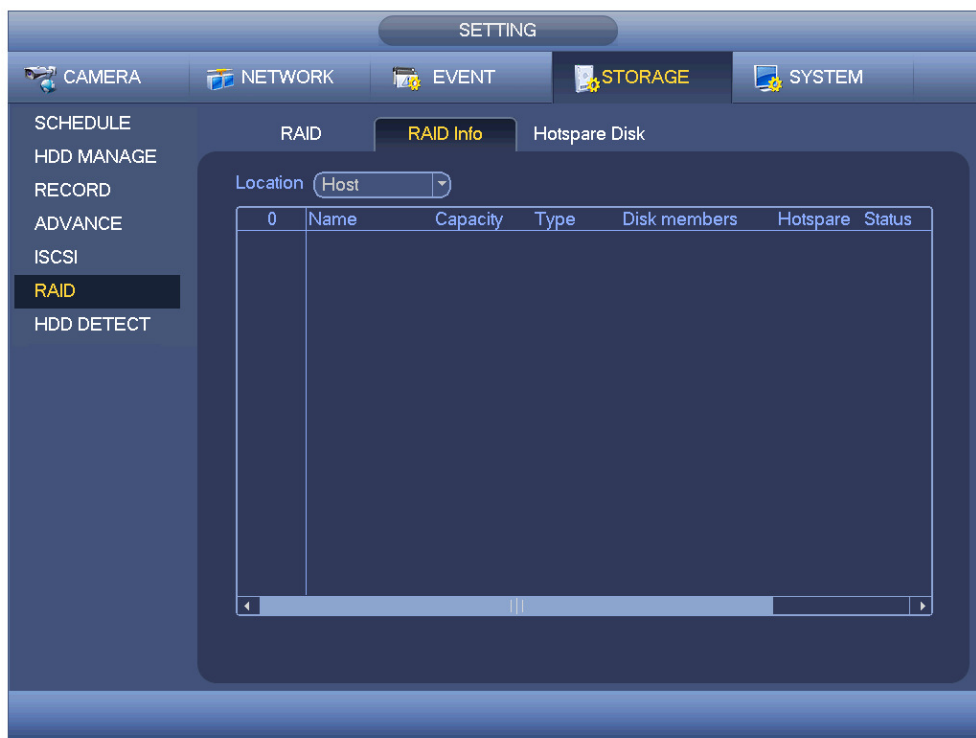

Figure 3-177

### 3.16.5.3 Hotspare Disks

From Main menu->Setting->Storage->RAID->Hotspare HDD, user may add the hotspare HDD. See Figure 3-178. The type includes two options:

- Global: It is global hotspare disk. When any RAID becomes degrading, it can replace and build the RAID.
- Local: It is local hotspare disk. When the specified RAID becomes degrading, it can replace and build the RAID.

Select a hot spare device and then click Delete button. Click Apply button to delete.



Figure 3-178

### 3.16.6 HDD Detect

The HDD detect function is to detect HDD current status so that user may clearly understand the HDD performance and replace the malfunction HDD.

There are two detect types:

- Quick detect: It is to detect the stored files on the HDD. User may use format function to repair the bad track. System can not detect the bad track if there is no record on the HDD.
- Global detect: It detects the whole HDD. The process may take a long time and may affect the HDD that is saving the record. If it detects the bad track, it may result from the damaged HDD.

#### 3.16.6.1 Manual Detect

The manual detect interface is shown as below. See Figure 3-179.

Please select detect type and HDD. Click start detect to begin. User may view the corresponding detect information.

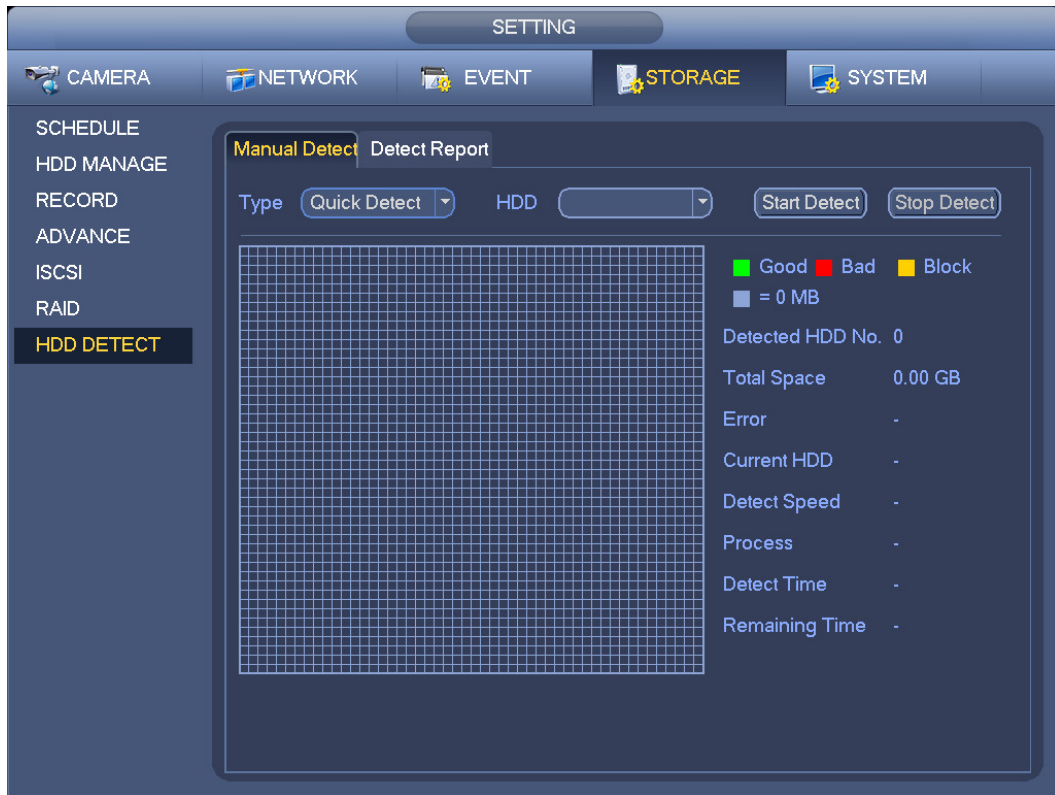

Figure 3-179

### 3.16.6.2 Detect Report

After the detect operation, user may go to the detect report to view corresponding information. The detect report interface is shown as below. See Figure 3-180.

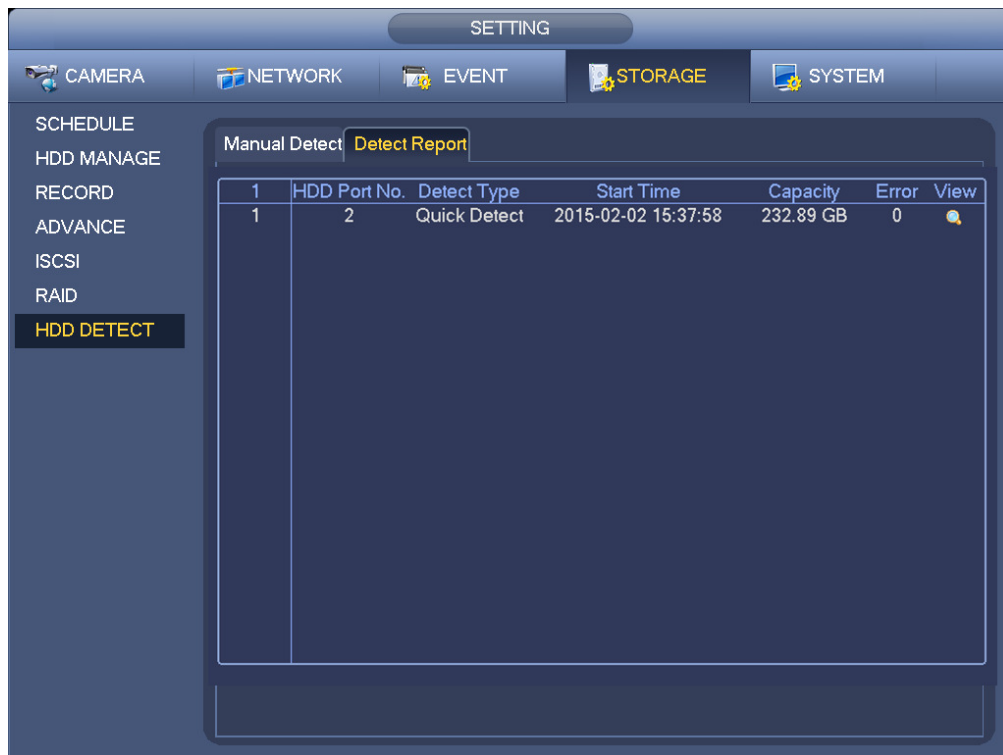

Figure 3-180

Click View, user may see the detailed information such as detect result, backup and S.M.A.R.T.

## 3.17 Basic Setups

Set NVR basic setup, device setup and other setups.

### 3.17.1 Device Setup

From Main menu->Setting->System->General->General, user may go to the general interface. See Figure 3-181.

- Pack duration: Here is for you to specify record duration. The value ranges from 0 to 120 minutes. Default value is 60 minutes.
- Device ID: Please input a corresponding device name here.
- Device No: When you are using one remote control (not included in the accessory bag) to control several NVRs, user may give a name to each NVR for your management.
- Language: System supports various languages: English, Italian, Japanese, French, Spanish (All languages listed here are optional. Slight difference maybe found in various series.)
- Video standard: There are two formats: NTSC and PAL.
- HDD full: Here is for you to select working mode when hard disk is full. There are two options: stop recording or rewrite. If current working HDD is overwritten or the current HDD is full while the next HDD is no empty, then system stops recording, If the current HDD is full and then next HDD is not empty, then system overwrites the previous files.
- Pack duration: Here is for you to specify record duration. The value ranges from 1 to 120 minutes. Default value is 60 minutes.
- Realtime play: It is to set playback time user may view in the preview interface. The value ranges from 5 to 60 minutes.



- Auto logout: Here is for you to set auto logout interval once login user remains inactive for a specified time. Value ranges from 0 to 60 minutes.
- Navigation bar: Check the box here, system displays the navigation bar on the interface.
- IPC Time Sync: User may input an interval here to synchronize the NVR time and IPC time.
- Startup wizard: Once you check the box here, system will go to the startup wizard directly when the system restarts the next time. Otherwise, it will go to the login interface.
- Mouse property: User may set double click speed via dragging the slide bard. User may Click Default button to restore default setup.



Figure 3-181

### 3.17.2 Date and Time

From Main menu->Setting->System->General->Date and time, user may go to the general interface. See Figure 3-182.

- System time: Here is for you to set system time
- Date format: There are three types: YYYY-MM-DD: MM-DD-YYYY or DD-MM-YYYY.
- Date separator: There are three denotations to separate date: dot, beeline and solidus.
- DST: Here user may set DST time and date by week or by date. Please enable DST function and then select setup mode. Please input start time and end time and click Save button.
- Time format: There are two types: 24-hour mode or 12-hour mode.
- NTP: It is to set NTP server, port and interval.

#### Note:

Since system time is very important, do not modify time casually unless there is a must!

Before your time modification, please stop record operation first!

After completing all the setups please click save button, system goes back to the previous menu.



Figure 3-182

### 3.17.3 Holiday

From Main menu->Setting->System->General->Holiday, holiday setup interface is shown as in Figure 3-183. Click Add new holiday button, user may input new holiday information. See Figure 3-184. Here user may set holiday name, repeat mode and start/end time.

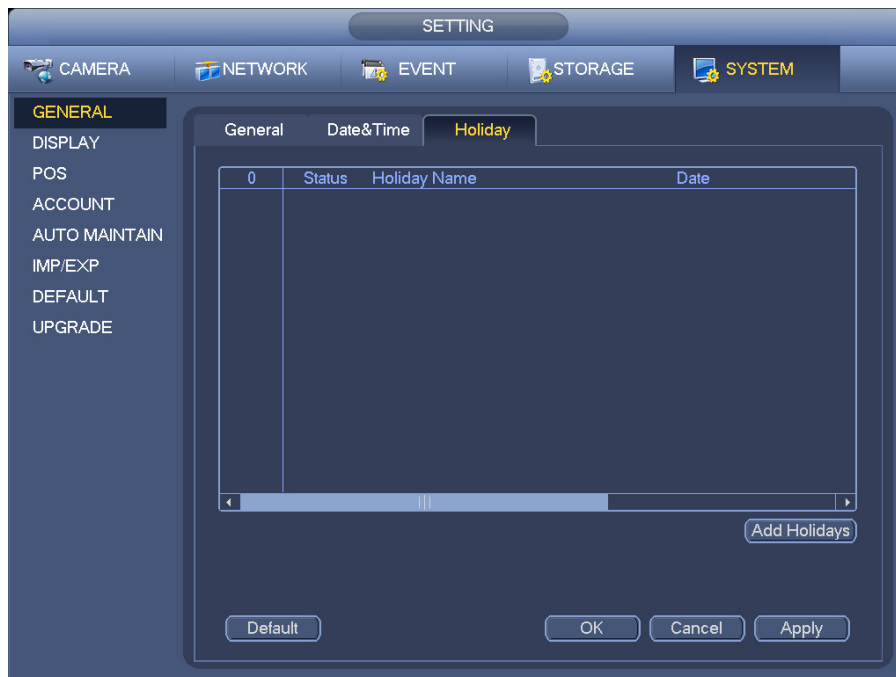

Figure 3-183



Figure 3-184

### 3.18 POS

Connect the NVR to the POS, it can receive the POS information and overlay on the corresponding record.

**Note**

POS info overlay and playback function is for 1-window only.

From main menu->Setting->System->POS, user may go to the following interface. See Figure 3-185.

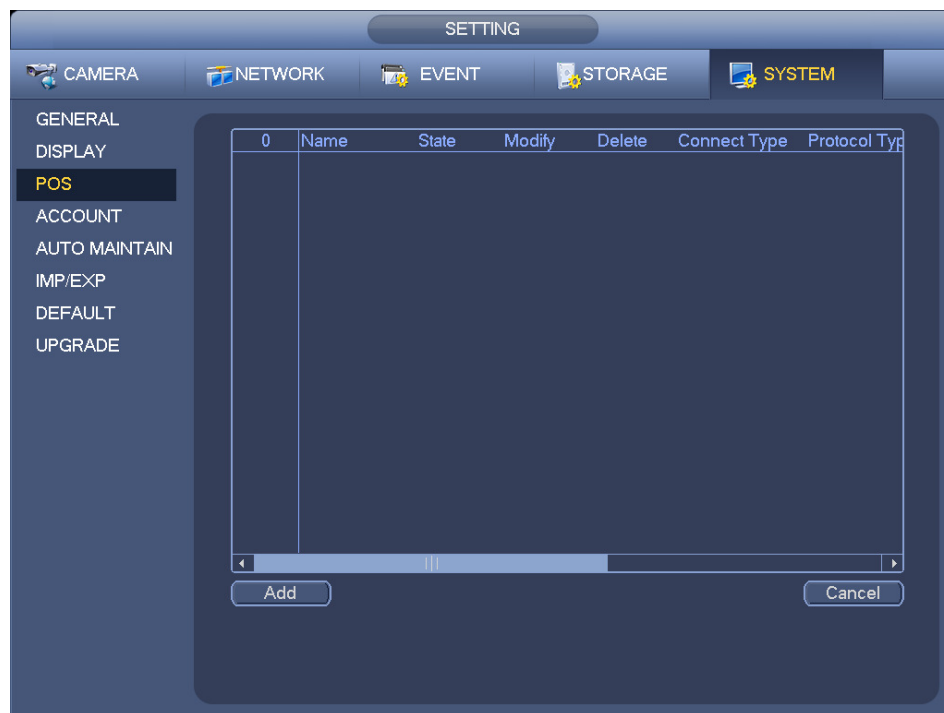

Figure 3-185

Click Add, user may see the following dialogue box. See Figure 3-186.



Figure 3-186

Check the box to enable POS function, Click Set button; user may see the following interface. See Figure 3-187.



Figure 3-187

Set source IP and destination IP, and then click OK. System goes back to Figure 3-186.

- Source IP: POS device IP address.
- Destination IP: NVR IP address.

In Figure 3-186, click Channel Set button, select the channel you want to overlay POS information. Click OK button to complete the setup.

**Tips**

: Click it to delete POS setup.

: Click it to change setup information.

### 3.19 Audio Broadcast

This function allows you to broadcast to the camera, or user may use several channels to establish a broadcast group.

From main menu->Setting->System->Voice, user may go to the following interface. See Figure 3-188.



Figure 3-188

Click Add button, user may add see the following interface. See Figure 3-189.

Please input a group name and select one or more channel(s).

Click Save button to complete the setup.

**Tips**



In Figure 3-188., click  to change broadcast setup, click  to delete broadcast setup.



Figure 3-189

After the setup, user may go to the preview interface, click  of the navigation bar; user may see the following interface. See Figure 3-190.

Check the box to select a group name and then click , user may realize audio broadcast function.

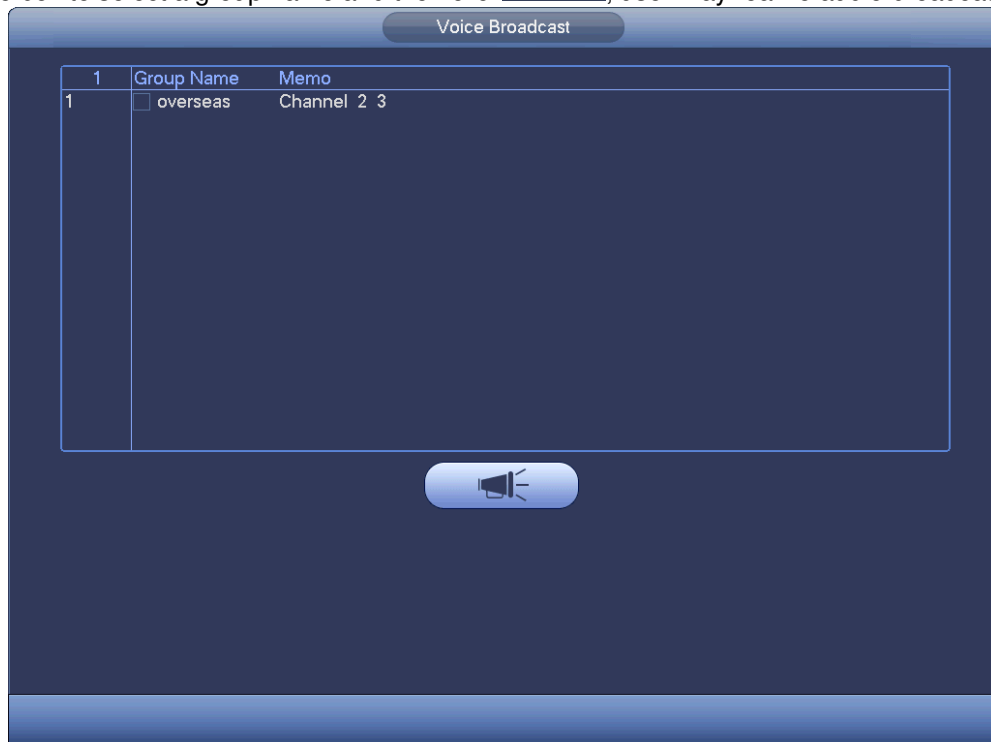

Figure 3-190

## 3.20 Device Maintenance and Manager

### 3.20.1 System Info

#### 3.20.1.1 Version

From main menu->Info->System->Version, user may go to version interface.

Here is for you to view some version information. See Figure 3-191. **Please note the following figure for reference only.**

- Model
- Channel
- Alarm in
- Alarm out
- System version
- Build Date
- Web
- SN
- ONVIF version



Figure 3-191

#### 3.20.1.2 BPS

From main menu->Info->System->BPS, here is for you to view current video bit rate (kb/s) and resolution. See Figure 3-192.

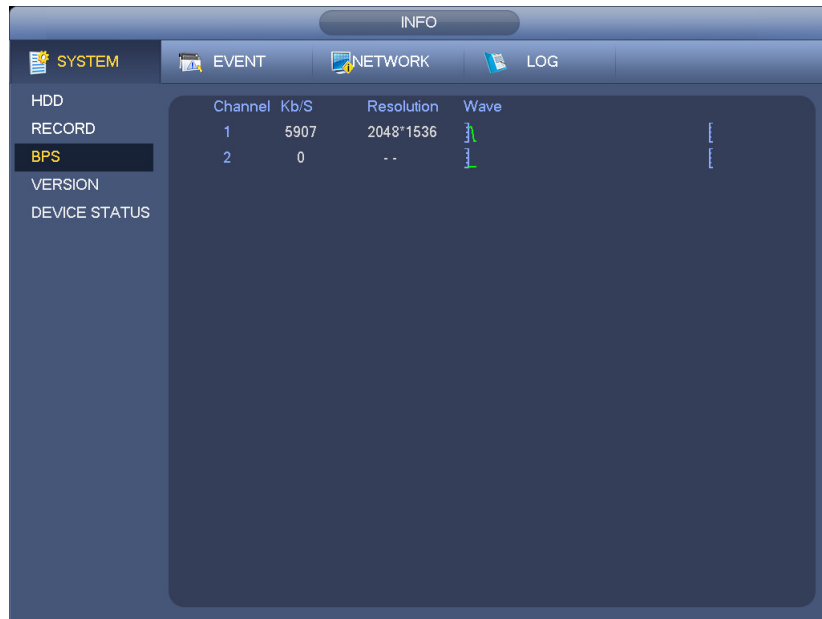

Figure 3-192

### 3.20.1.3 Device Status

From main menu->Info->System->Device status, here is for you to view device current status. See Figure 3-194. The red highlighted fan means current fan is malfunction.



Figure 3-193

### 3.20.1.4 Online User

From main menu->Info->System->Online user, here is for you manage online users connected to your NVR. See Figure 3-194.

User may click button  to disconnect or block one user if you have proper system right.

System detects there is any newly added or deleted user in each five seconds and refresh the list



automatically.

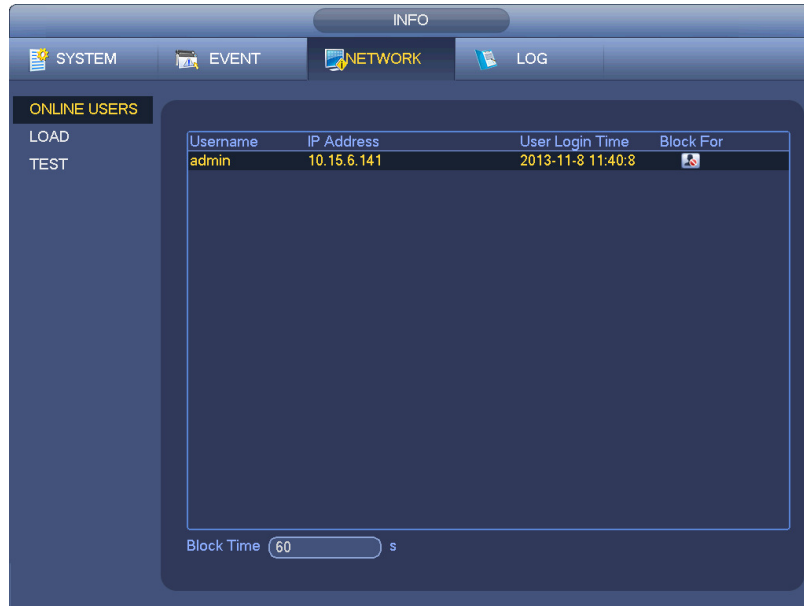

Figure 3-194

### 3.20.1.5 Remote Device Information

#### 3.20.1.5.1 Alarm Status

From main menu->Info->Event->alarm status, here user may view the channel status of the remote device, connection log and etc. See Figure 3-195.



Figure 3-195

#### 3.20.1.5.2 Analytics

It is to display channel video diagnosis results. User may view histogram and a list to view the occurred times in the specified period.

From main menu->Info->Event->Analytics, user may go to the following interface.

Input start time, end time, select a channel and then click Search button. User may see the following interface. See Figure 3-196.

**Tips**

Click the name at the bottom of the histogram or select type from the dropdown list; user may filter the displayed type.



Figure 3-196

3.20.1.5.3 People Counting

It is to search and view the people counting results of each channel. System can export people counting report. The export file extension name is .bmp.

From main menu->Info->Event->People Counting, user may go to the following interface. See Figure 3-197.

Channel: Please select a channel from the dropdown list.

- Type: Please select report type from the dropdown list. It includes daily report/monthly report/annual report. User may click to select histogram or polygon chart.
- Start time/end time: Input start time and end time of the people counting.
- Enter: Check to search enter amount.
- Exit: Check the box to search exit amount.
- Display No.: Check the box, system can display enter and exit people amount in the report.



Figure 3-197

#### 3.20.1.5.4 Heat Map

It is to search and view the heat map of each channel.

From main menu->Info->Event->Heat Map, user may go to the following interface. See Figure 3-198.

Select a channel, input start time and end time. Please note the report search period shall be within one month.

Click Search button, user may view the heat map report.







Figure 3-198

### 3.20.1.6 Remote

#### 3.20.1.6.1 Device Status

From main menu->Setting->Remote->Status, here user may view the IPC status of the corresponding channel such as motion detect, video loss, tampering, alarm and etc. See Figure 3-199.

- IPC status: : Front-end does not support. : Front-end supports. : There is alarm event from current front-end.
- Connection status: : Connection succeeded. : Connection failed.
- Refresh: Click it to get latest front-end channel status.

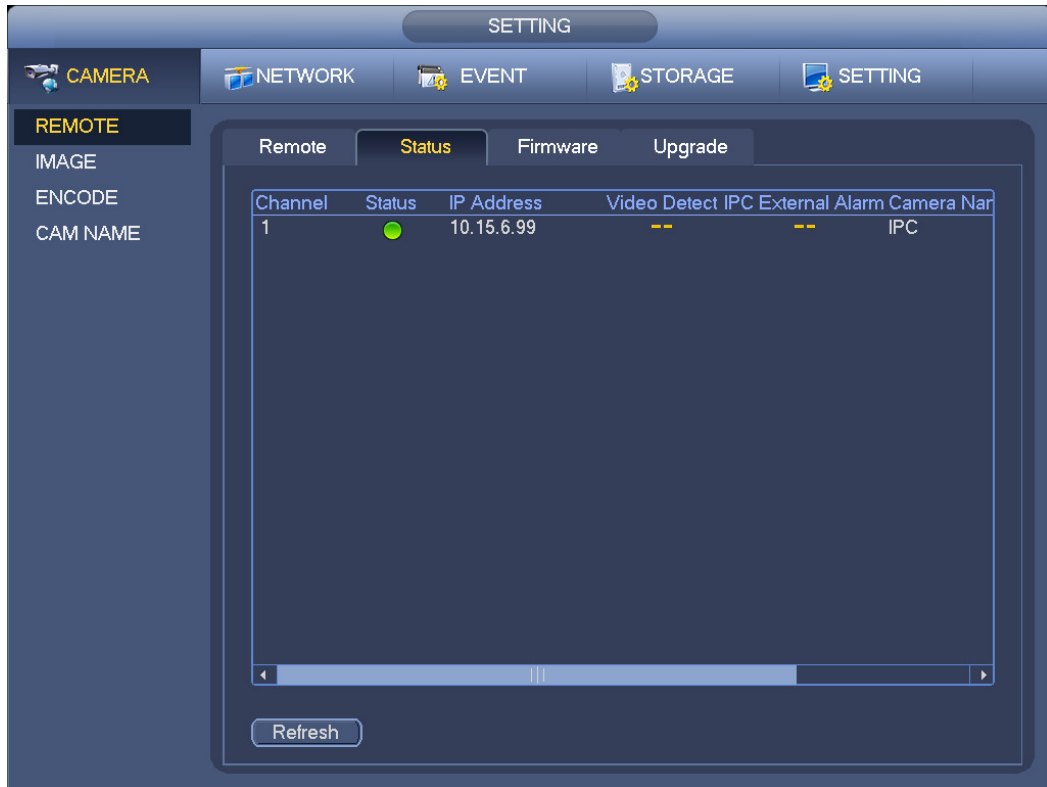

Figure 3-199

### 3.20.1.6.2 Firmware

From main menu->Setting->Remote->Firmware, it is to view channel, IP address, manufacturer, type, system version, SN, video input, audio input, external alarm and etc. See Figure 3-200.



Figure 3-200

### 3.20.2 Log

From Main menu->Info->Log, user may go to the following interface. See Figure 3-201.

- Start time/end time: Pleased select start time and end time, then click search button. User may view the log files in a list. System max displays 100 logs in one page. It can save 500,000 logs on the HDD, and 16384 logs on the system. System max supports 500,000+16384 logs if there is a HDD. System max supports 16384 logs if there is no HDD. Please use page up/down button on the interface or the front panel to view more.

#### Tips

Double click a log item to view its detailed information. See Figure 3-202.

Click PgUp/PgDn to view more logs.

The screenshot shows a web-based interface for viewing system logs. At the top, there are navigation tabs for SYSTEM, EVENT, NETWORK, and LOG. The LOG tab is selected. Below the tabs, there are search filters: Start Time (2014-06-20 00:00:00), End Time (2014-06-21 00:00:00), and Type (All). A Search button is located to the right of the Type dropdown. The main area contains a table of log entries. The table has columns for Record Time, Event, Play, and Details. The entries show user login and logout events for the IP address 10.15.5.219. At the bottom of the interface, there are pagination controls: PgUp, PgDn, 1/33(Current/Total Page), Go To, 1 Page(s), Backup, and Clear.

	Record Time	Event	Play	Details
87	2014-06-20 16:30:55	User logged in.<10.15.5.219>	--	
88	2014-06-20 16:30:55	User logged in.<10.15.5.219>	--	
89	2014-06-20 16:30:52	User logged out.<10.15.5.219>	--	
90	2014-06-20 16:30:52	User logged out.<10.15.5.219>	--	
91	2014-06-20 16:30:52	User logged in.<10.15.5.219>	--	
92	2014-06-20 16:30:52	User logged in.<10.15.5.219>	--	
93	2014-06-20 16:30:49	User logged out.<10.15.5.219>	--	
94	2014-06-20 16:30:49	User logged out.<10.15.5.219>	--	
95	2014-06-20 16:30:49	User logged in.<10.15.5.219>	--	
96	2014-06-20 16:30:49	User logged in.<10.15.5.219>	--	
97	2014-06-20 16:30:46	User logged out.<10.15.5.219>	--	
98	2014-06-20 16:30:46	User logged out.<10.15.5.219>	--	
99	2014-06-20 16:30:46	User logged in.<10.15.5.219>	--	
100	2014-06-20 16:30:46	User logged in.<10.15.5.219>	--	

Figure 3-201



Figure 3-202

### 3.20.3 Account

From main menu->Setting->System->Account, here is for you to implement account management. See Figure 3-203. Here user may:

- Add new user
- Modify user
- Add group
- Modify group
- Modify password.

For account management please note:

- For the user account name and the user group, the string max length is 6-byte. The backspace in front of or at the back of the string is invalid. There can be backspace in the middle. The string includes the valid character, letter, number, underline, subtraction sign, and dot.
- The default user amount is 64 and the default group amount is 20. System account adopts two-level management: group and user. No limit to group or user amount.
- For group or user management, there are two levels: admin and user.
- The user name and group name can consist of eight bytes. One name can only be used once. There are four default users: admin/888888/666666 and hidden user "default". Except user 6666, other users have administrator right.
- Hidden user "default" is for system interior use only and can not be deleted. When there is no login user, hidden user "default" automatically login. User may set some rights such as monitor for this user so that user may view some channel view without login.
- One user should belong to one group. User right can not exceed group right.
- About reusable function: this function allows multiple users use the same account to login.

After all the setups please click save button, system goes back to the previous menu.



Figure 3-203

### 3.20.3.1.1 Add User

Click modify user button in Figure 3-203 , the interface is shown as in Figure 3-204.

Please input the user name, password, select the group it belongs to from the dropdown list.

Then user may check the corresponding rights for current user.

For convenient user management, usually we recommend the general user right is lower than the admin account.

- **Username:** admin. **Password:** admin. (administrator, local and network)
- **Username:** 888888. **Password:** 888888. (administrator, local only)
- **Username:** default. **Password:** default (hidden user). Hidden user “default” is for system interior use only and can not be deleted. When there is no login user, hidden user “default” automatically login. User may set some rights such as monitor for this user so that user may view some channels without login.



Figure 3-204

When you create a new user, user may input the corresponding MAC address of current user. If you leave this item in blank, any MAC address user can share this user account to login. Please note system needs to check the validity of MAC. Only the 12-digit 0-f format address can pass the validity verification. System only saves small character even you input capitalized one. User may see the corresponding prompt if there is any illegal input.

Click the Set button after the period, user may set valid period to use current account. See Figure 3-205.



Figure 3-205

Click Set button, user may set six periods in one day. See Figure 3-206.  
 Check the box after the period, user may enable current setup.



Figure 3-206

### 3.20.3.1.2 Modify user

Click , user may go to the following interface to change user information. See Figure 3-207.

For admin, 888888, and default (hidden user), user may not change period setup.



Figure 3-207

#### 3.20.3.1.3 Change Password

In Figure 3-207, check the Modify password box, user may change password. Please input old password, and then input new password twice to confirm.

The password can contain 32-byte and the space at the beginning or at the end of the password are null. It can contain in the middle of the password. For the user of account right, it can change the password of other users.

#### 3.20.3.1.4 Add/Modify Group

In Figure 3-203, click Group button, user may see the following interface. See Figure 3-208.



Figure 3-208

Click add group button in Figure 3-208 , the interface is shown as below. See Figure 3-209. Here user may input group name and then input some memo information if necessary. There are total 98 rights such as control panel, shut down, real-time monitor, playback, record, record file backup, PTZ, user account, system information view, alarm input/output setup, system setup, log view, clear log, upgrade system, control device and etc.



Figure 3-209

#### 3.20.3.1.5 Security Question

**Note**

This function is for administrator only.

The security question is shown as below. See Figure 3-210.

Here user may change security questions. User may select from the dropdown list or input customized questions. Click Set button, user may save current setup. User may correctly answer the security questions to reset password of admin account.

**Tips**

Input proper answer and then click Delete button, user may reset security password.

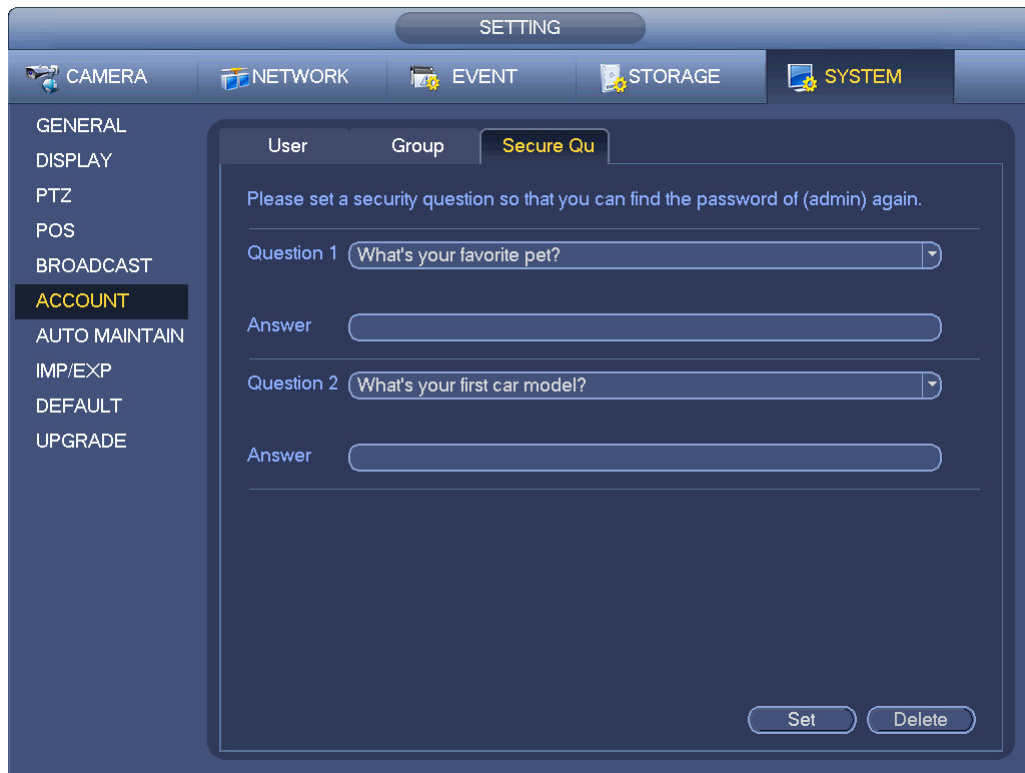

Figure 3-210

### 3.20.4 Update

From Mani menu->Setting->Info->Update, user may go to the following interface. See Figure 3-211.

- a) Insert USB device that contain the upgrade file.
- b) Click Start button and then select the .bin file.
- c) User may see the corresponding dialogue box after the update process is complete.



Figure 3-211

### 3.20.5 Default

User may restore factory default setup to fix some problems when the device is running slowly. Configuration error occurred.

From Main menu->Setting->System->Default, user may go to the default interface. See Figure 3-212.

Click default icon, system pops up a dialogue box. User may highlight  to restore factory default setup.

- All
- Camera
- Network
- Event
- Storage
- System

Please highlight icon  to select the corresponding function.

Click factory reset button, user may restore factory default setup.

After all the setups please click OK button, system goes back to the previous menu.

#### **Warning!**

After you use default function, some your customized setup may lose forever! Please think twice before you begin the operation!



Figure 3-212

### 3.20.6 Auto Maintain

From Main menu->Setting->System->Auto maintain, here user may set auto-reboot time and auto-delete old files setup. User may set to delete the files for the specified days. See Figure 3-213.

User may select proper setup from dropdown list.

After all the setups please click save button, system goes back to the previous menu.



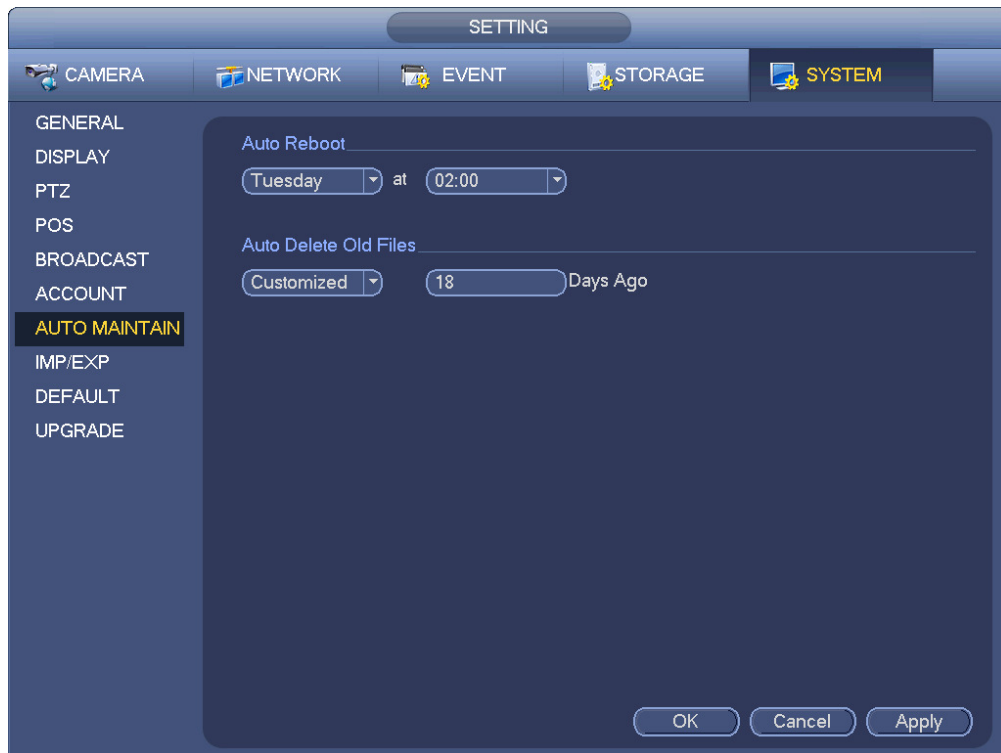

Figure 3-213

### 3.20.7 Logout /Shutdown/Restart

From Main menu->Operation->Shutdown, user may see an interface shown as in Figure 3-214.

- Shutdown: System shuts down and turns off power.
- Logout: Log out menu. You need to input password when you login the next time.
- Restart: Reboot device.

If you shut down the device, there is a process bar for your reference, system waits for 3 seconds and then shut down (User may not cancel).

Please note, sometimes you need to input the proper password to shut down the device.

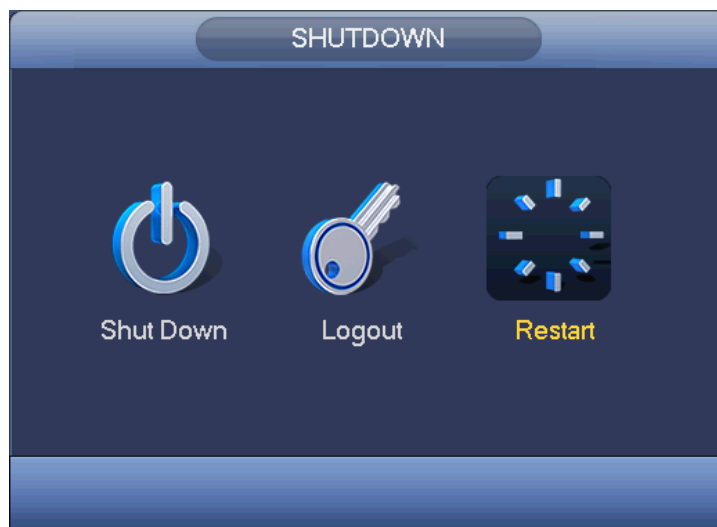

Figure 3-214

## 4 Web Operation

### 4.1 General Introduction

The device web provides channel monitor menu tree, search, alarm setup, system setup, PTZ control and monitor window and etc.

#### 4.1.1 Preparation

Before log in, please make sure:

- PC and NVR connection is OK.
- You have set PC IP address, NVR IP address, subnet mask and gateway. (Please set the IP address of the same section for the PC and NVR. Please input corresponding gateway and subnet mask if there are routers.) This series product max supports 4 network adapters. The default setup is eth1:192.168.1.108, eth2: 192.168.1.106, eth3:192.168.1.105 and eth4:192.168.1.104.
- Use order ping `***.***.***.***`(NVR IP address) to check connection is OK or not.

#### 4.1.2 Log in

Open the IE and then input the NVR IP address in the address column.

For example, if your NVR IP address is 192.168.1.108, then please input `http:// 192.168.1.108` in IE address column. See Figure 4-1.

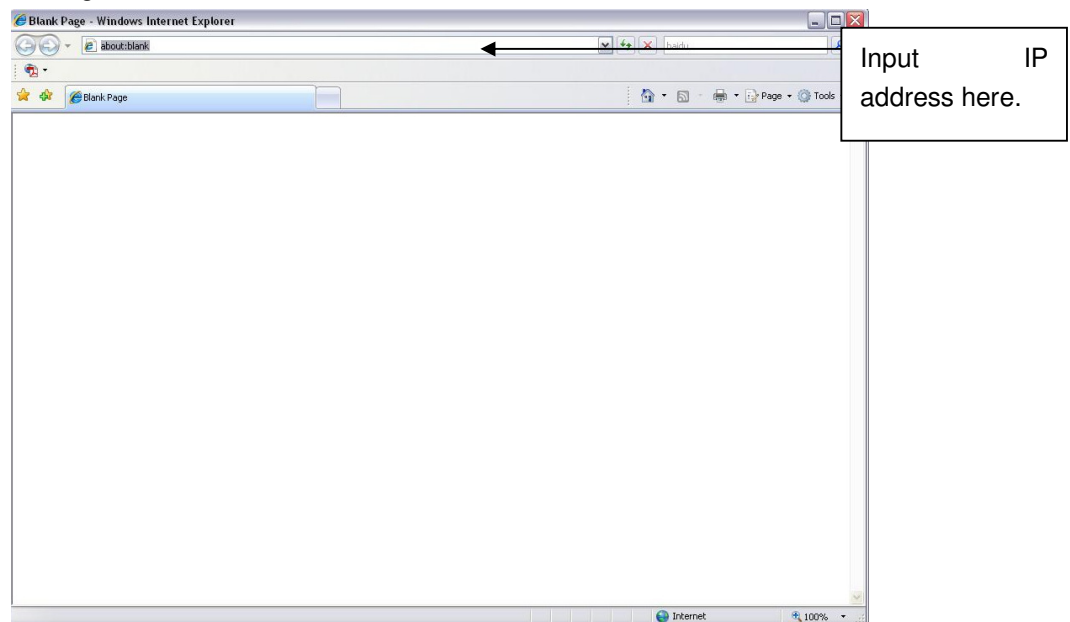

Figure 4-1

System pops up warning information to ask you whether install webrec.cab control or not. Please click yes button.

If user can't download the ActiveX file, please modify your settings as follows. See Figure 4-2.

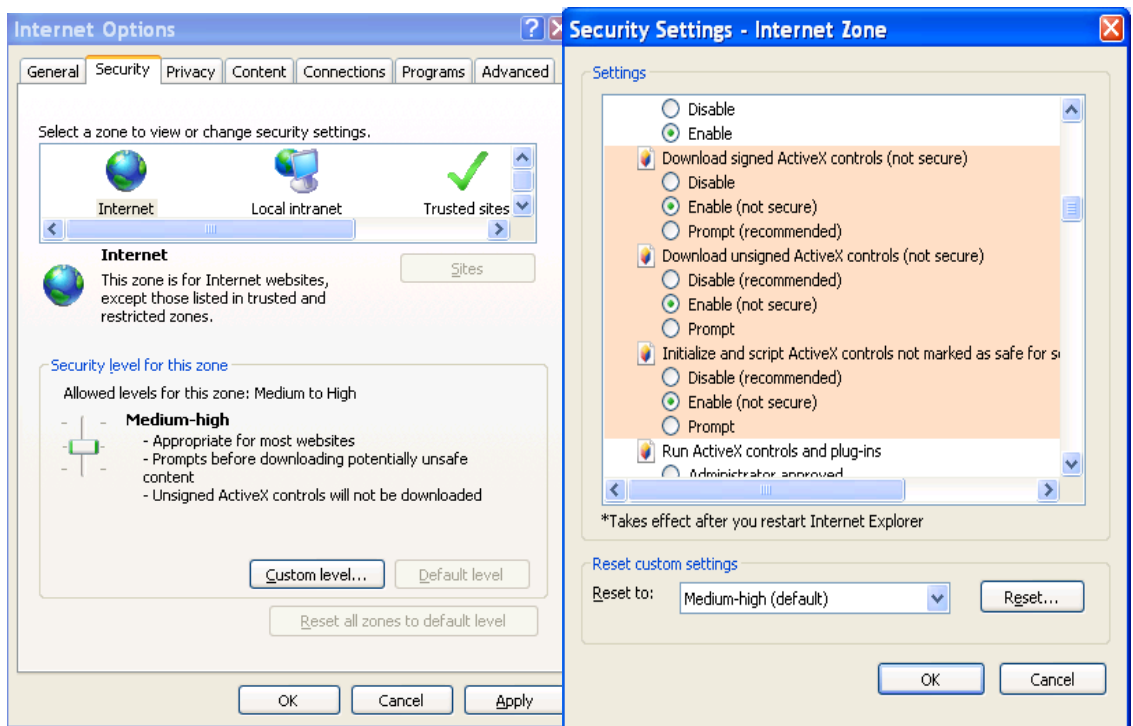

Figure 4-2

After installation, the interface is shown as below. See Figure 4-3.

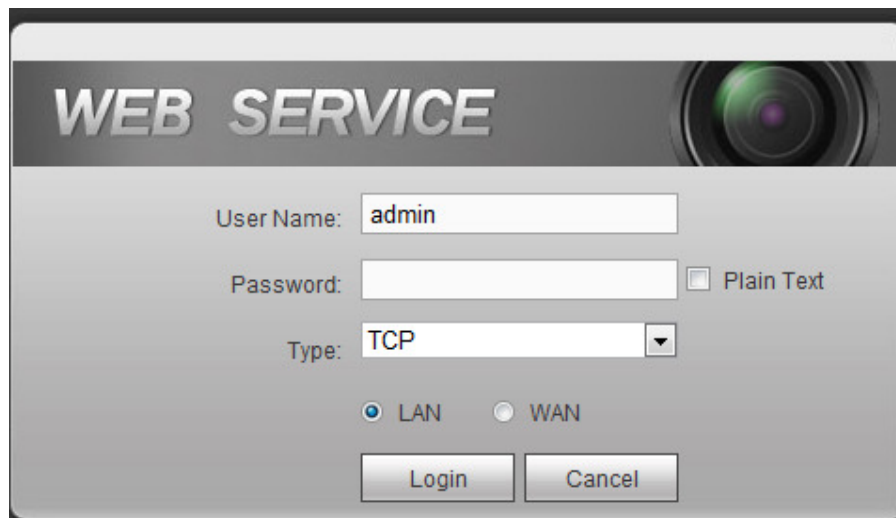

Figure 4-3

Please input your user name and password.

Default factory name is **admin** and password is **admin**.

System pops up the following dialogue box for you to change default administrator password. See Figure 4-4.



The image shows a dialog box titled "ADMIN SECURITY". It contains three input fields: "User Name" with the text "admin", "New Password" which is empty, and "Confirm Password" which is also empty. Below the "New Password" field are three radio buttons labeled "Low", "Middle", and "High", with "Low" selected. At the bottom of the dialog are two buttons: "Save" and "Cancel". Below the input fields, there are three lines of asterisked text: "\* For your device safety, please change administrator default password.", "\* The password max has 6-digit containing letters, numbers and other special characters.", and "\* Usually the password shall not be the same as the user name."

Figure 4-4

**For your own safety, please change the default password after you first login.**

Click Cancel button, system pops up the following dialogue box to confirm the exit. See Figure 4-5.

Check the box here, system will not pop up the change password interface the next time.

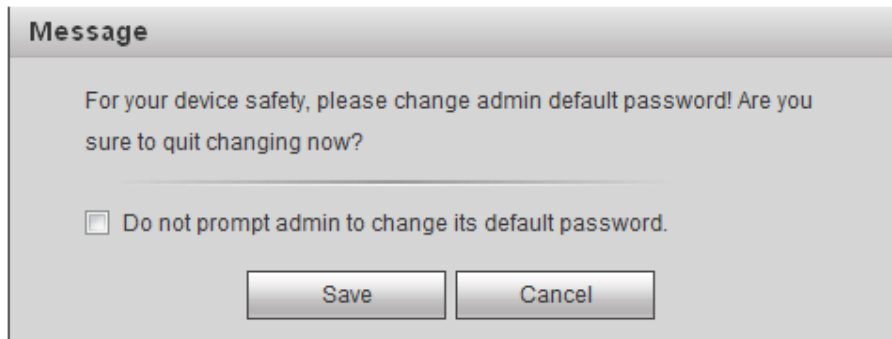

The image shows a dialog box titled "Message". It contains a text message: "For your device safety, please change admin default password! Are you sure to quit changing now?". Below the message is a checkbox with the text "Do not prompt admin to change its default password." At the bottom of the dialog are two buttons: "Save" and "Cancel".

Figure 4-5

## 4.2 LAN Mode

For the LAN mode, after you logged in, user may see the main window. See Figure 4-6.

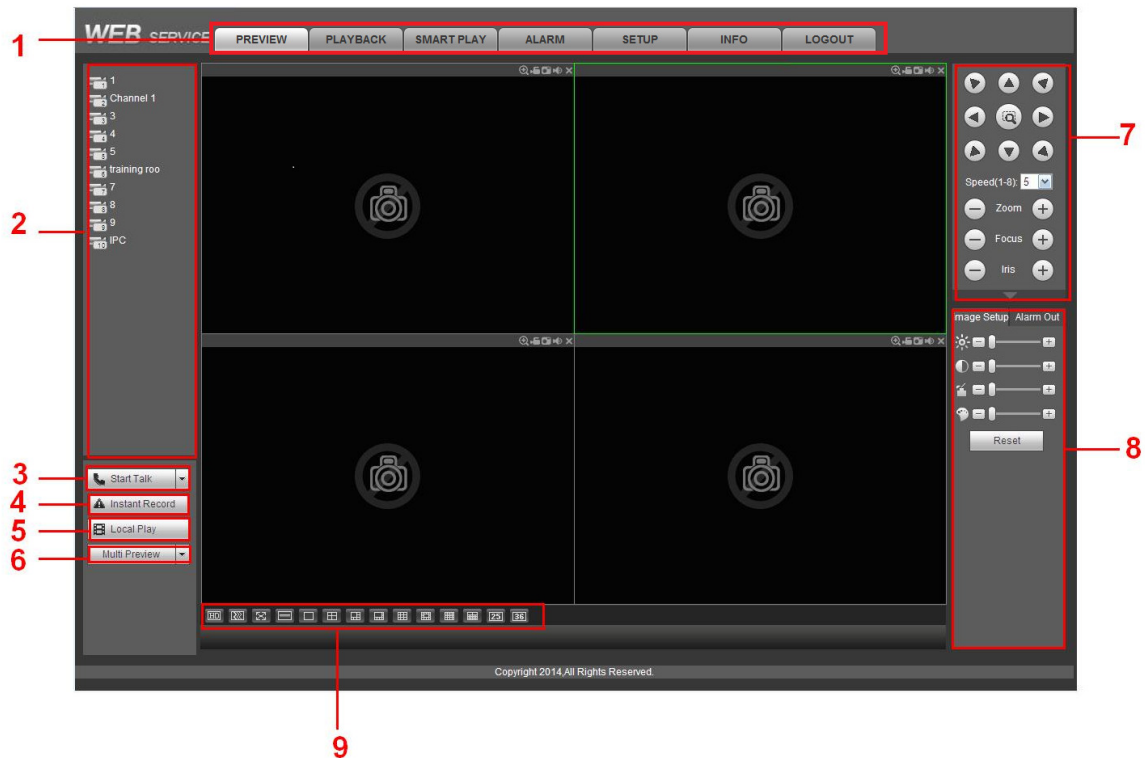

Figure 4-6

This main window can be divided into the following sections.

- Section 1: There are seven function buttons: Preview (chapter 4.3), setup (chapter 4.8), info (Chapter 4.9), playback (chapter 4.10), smart play (chapter: 4.11), alarm (chapter 0), and logout (chapter 4.13).
- Section 2: There are monitor channels successfully connected to the NVR. Please refer to Figure 4-7 for main stream and extra stream switch information.

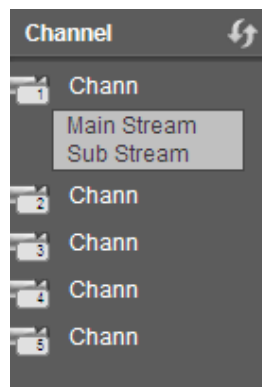

Figure 4-7

- Section 3: Start Talk button.

User may click this button to enable audio talk. Click 【▼】 to select bidirectional talk mode. There are four options: DEFAULT, G711a, G711u and PCM. See Figure 4-8.

After you enable the bidirectional talk, the Start talk button becomes End Talk button and it becomes yellow. Please note, if audio input port from the device to the client-end is using the first channel audio input port. During the bidirectional talk process, system will not encode the audio data from the 1-channel.

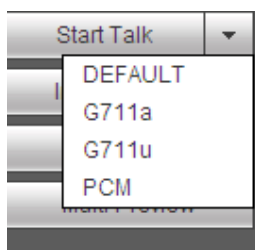

Figure 4-8

- Section 4: Instant record button. Click it, the button becomes yellow and system begins manual record. See Figure 4-9. Click it again, system restores previous record mode.

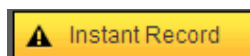

Figure 4-9

- Section 5: Local play button.

The Web can playback the saved (Extension name is dav) files in the PC-end.

Click local play button, system pops up the following interface for you to select local play file. See Figure 4-10.



Figure 4-10

- Section 6: Zero-channel encoding. Please refer to chapter 4.6 for detailed information.
- Section 7: PTZ operation panel. Please refer to chapter 4.4 for detailed information.
- Section 8: Image setup and alarm setup. Please refer to chapter 4.5 for detailed information.
- Section 9: From the left to the right ,user may see video quality/fluency/ full screen/1-window/4-window/6-window/8-window/9-window/13-window/16-window/20-window/25-window/36-window.. User may set video fluency and real-time feature priority.

### 4.3 Real-Time Monitor

In section 2, left click the channel name you want to view, user may see the corresponding video in current window.

On the top left corner, user may view device IP(172.11.10.11), channel number(1), network monitor bit stream(2202Kbps) and stream type(M=main stream, S=sub stream). See Figure 4-11.

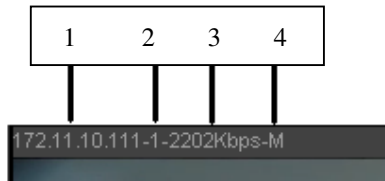

Figure 4-11

On the top right corner, there are six function buttons. See Figure 4-12.



Figure 4-12

- 1: Fisheye: Click it to change fisheye installation mode and display mode.
- 2: Digital zoom: Click this button and then left drag the mouse in the zone to zoom in. right click mouse system restores original status.
- 3: Local record. When you click local record button, the system begins recording and this button becomes highlighted. User may go to system folder RecordDownload to view the recorded file.
- 4: Snapshot picture. User may snapshot important video. All images are memorized in system client folder PictureDownload (default).
- 5: Audio :Turn on or off audio.(It has no relationship with system audio setup )
- 6: Close video.

## 4.4 PTZ

Before PTZ operation, please make sure you have properly set PTZ protocol.

There are eight direction keys. In the middle of the eight direction keys, there is a 3D intelligent positioning key.

Click 3D intelligent positioning key, system goes back to the single screen mode. Drag the mouse in the screen to adjust section size. It can realize PTZ automatically.

Please refer to the following sheet for PTZ setup information.

Parameter	Function
Scan	<ul style="list-style-type: none"> <li>● Select Scan from the dropdown list.</li> <li>● Click Set button, user may set scan left and right limit.</li> <li>● Use direction buttons to move the camera to you desired location and then click left limit button. Then move the camera again and then click right limit button to set a right limit.</li> </ul>
Preset	<ul style="list-style-type: none"> <li>● Select Preset from the dropdown list.</li> <li>● Turn the camera to the corresponding position and Input the preset value. Click Add button to add a preset.</li> </ul>

Parameter	Function
Tour	<ul style="list-style-type: none"> <li>● Select Tour from the dropdown list.</li> <li>● Input preset value in the column. Click Add preset button, you have added one preset in the tour.</li> <li>● Repeat the above procedures user may add more presets in one tour.</li> <li>● Or user may click delete preset button to remove one preset from the tour.</li> </ul>
Pattern	<ul style="list-style-type: none"> <li>● Select Pattern from the dropdown list.</li> <li>● User may input pattern value and then click Start button to begin PTZ movement such as zoom, focus, iris, direction and etc. Then user may click Add button to set one pattern.</li> </ul>
Aux	<ul style="list-style-type: none"> <li>● Please input the corresponding aux value here.</li> <li>● User may select one option and then click AUX on or AUX off button.</li> </ul>
Light and wiper	User may turn on or turn off the light/wiper.

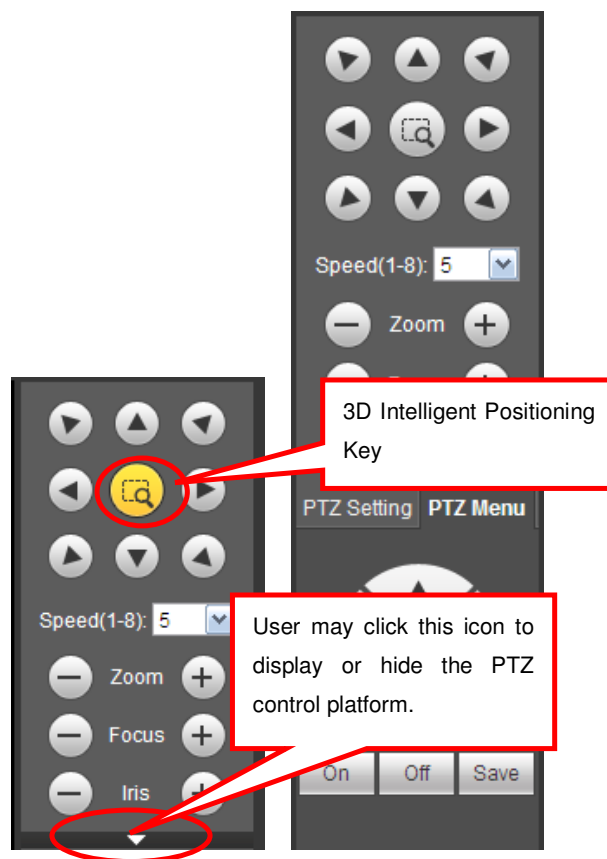

Figure 4-13



## 4.5 Image/Alarm-out

Select one monitor channel video and then click Image button in section 9, the interface is shown as Figure 4-14.

### 4.5.1 Image

Here user may adjust its brightness, contrast, hue and saturation. (Current channel border becomes green).

Or user may click Reset button to restore system default setup.

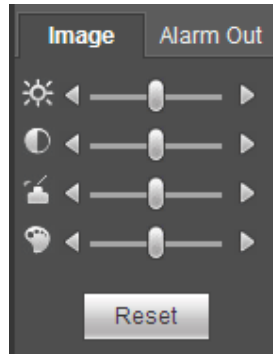

Figure 4-14

### 4.5.2 Alarm Output

Here user may enable or disable the alarm signal of the corresponding port. See Figure 4-15.



Figure 4-15

## 4.6 Zero-channel Encode

Select a window and then click zero-channel encode button, the interface is shown as below. See Figure 4-16.

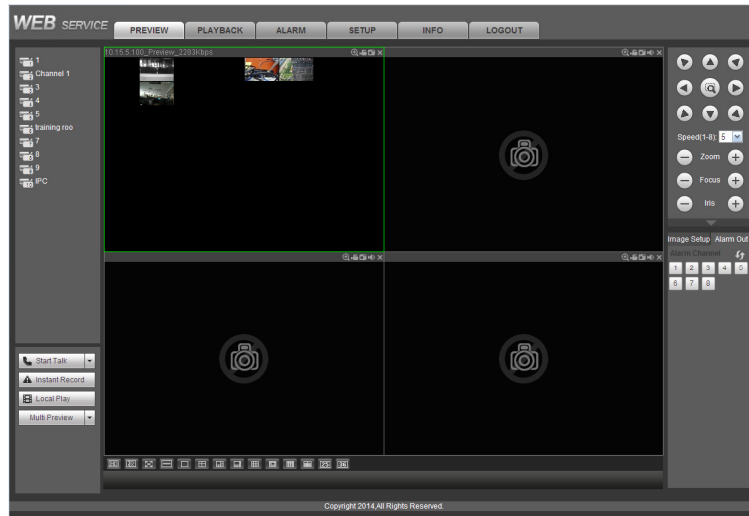

Figure 4-16

## 4.7 WAN Login

In WAN mode, after you logged in, the interface is shown as below. See Figure 4-17.

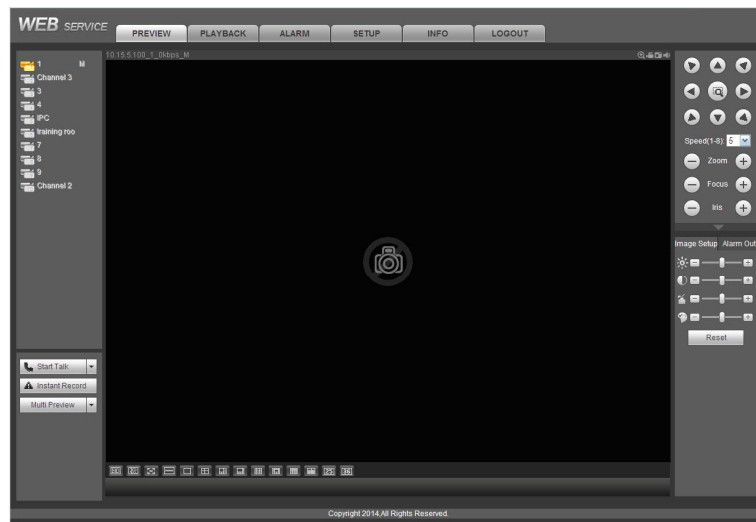

Figure 4-17

Please refer to the following contents for LAN and WAN login difference.

- 1) In the WAN mode, system opens the main stream of the first channel to monitor by default. The open/close button on the left pane is null.
- 2) User may select different channels and different monitor modes at the bottom of the interface. See Figure 4-18.

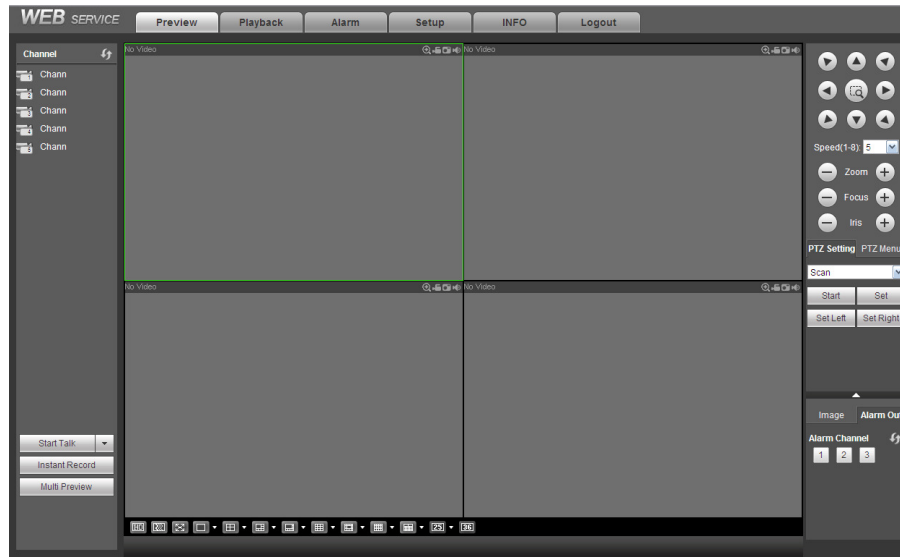

Figure 4-18

**Important**

**The window display mode and the channel number are by default. For example, for the 16-channel, the max window split mode is 16.**

3) Multiple-channel monitor, system adopts extra stream to monitor by default. Double click one channel, system switches to single channel and system uses main stream to monitor. User may view there are two icons at the left top corner of the channel number for you reference. M stands for main stream. S stands for sub stream (extra stream).

4) If you login via the WAN mode, system does not support alarm activation to open the video function in the Alarm setup interface.

**Important**

- For multiple-channel monitor mode, system adopts extra stream to monitor by default. User may not modify manually. All channels are trying to synchronize. Please note the synchronization effect still depends on your network environments.
- For bandwidth consideration, system can not support monitor and playback at the same time. System auto closes monitor or playback interface when you are searching setup in the configuration interface. It is to enhance search speed.

**4.8 Setup**

**4.8.1 Camera**

4.8.1.1 Remote Device

4.8.1.1.1 Remote Device

From main window->Setup->Camera->Remote device->Remote device, user may see remote device interface is shown as below. See Figure 4-19.

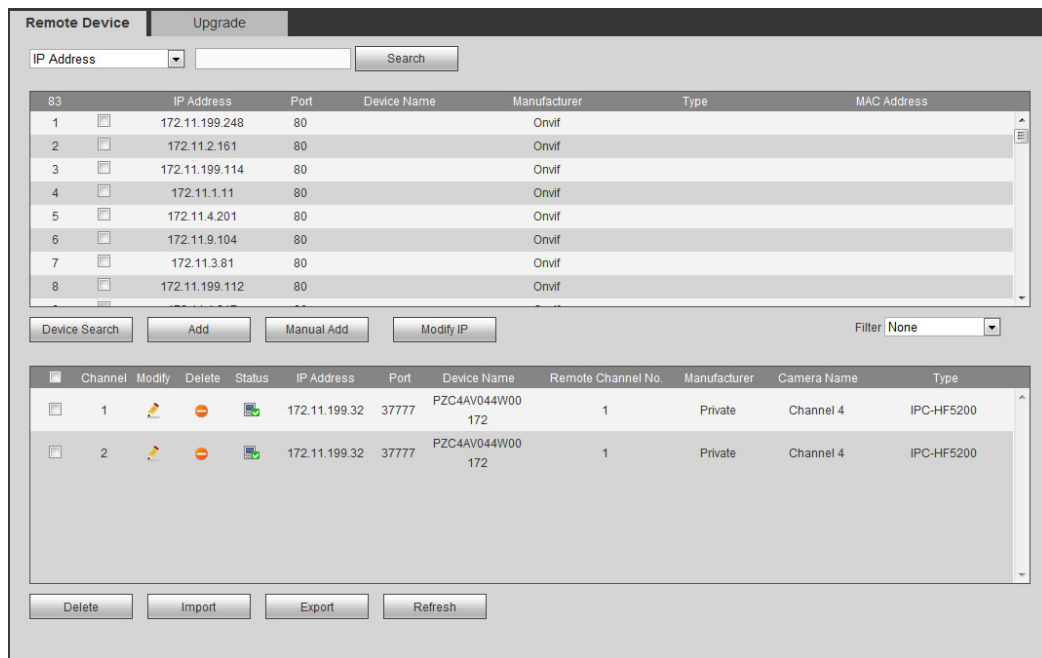

Figure 4-19

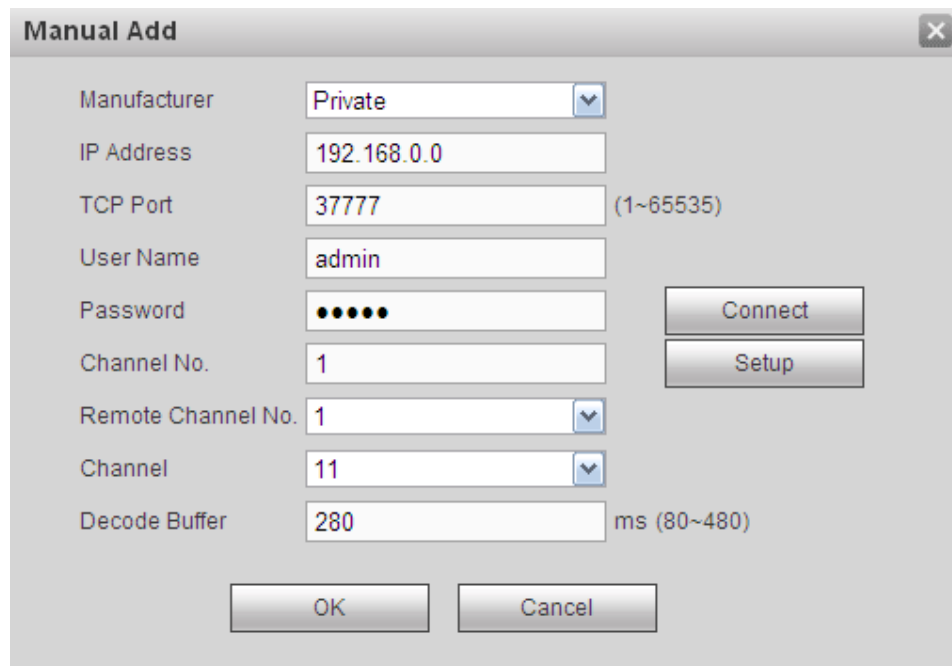





Figure 4-20

Please refer to the following sheet for log parameter information.

Parameter	Function
Device search	Click Device search button, user may view the searched device information on the list. It includes device IP address, port, device name, manufacturer and type.

Add	Select a device in the list and then click Add button, system can connect the device automatically and add it to the Added device list. Or user may double click one item in the list to add a device. <b>Tips</b> User may select several addresses to add at the same time.
Modify	Click  or any device in the Added device list, user may change the corresponding channel setup.
Delete	Click  , user may delete the remote connection of the corresponding channel.
Connection status	 : Connection succeeded.  : Connection failed.
Delete	Select a device in the Added device list and then click Delete button, system can disconnect the device and remove it from the Added device list.
Manual Add	Click it, the interface is shown as in Figure 4-20. Here user may add network camera manually. User may select a channel from the dropdown list (Here only shows disconnection channel.). <b>Note:</b> <ul style="list-style-type: none"> <li>● System supports manufactures such as Panasonic, Sony, Dynacolor, Samsung, AXIS, Arecont, Dante and Onvif standard protocol.</li> <li>● If you do not input IP address here. System uses default IP 192.168.0.0 and system does not connect to this IP.</li> <li>● Can not add two devices at the same time. Click OK button here, system only connect to the corresponding device of current channel.</li> </ul>

### Change IP

On the searched devices list, check one or more device(s) at the same time. Click Modify IP button, user may see the following interface. See Figure 4-21

Please refer to the following sheet for log parameter information.

Parameter	Function
DHCP	Check the box here, system can auto allocate the IP address. The IP address, subnet mask, default gateway are reference only.
Static	Check the box here, user may set IP address, subnet mask, default gateway manually.
IP address/subnet mask/default gateway	User may input corresponding information here.
User name/password	The account you login the remote device. Please input here to password verification to change the remote device password.

Parameter	Function
Incremental value	When you want to change several IP addresses, once you input the IP address of the first device, the IP address of the next device will increase accordingly. For example, when the incremental value is 1, if the IP address of the first device is 172.10.3.128, the IP address of the second device will auto be set as 172.10.3.129.

**Note**

For the static IP address, system will alert you if there is any IP conflict. If you are changing several IP addresses at the same time, system auto skip the conflicted IP and auto allocate again according to the incremental value you set.

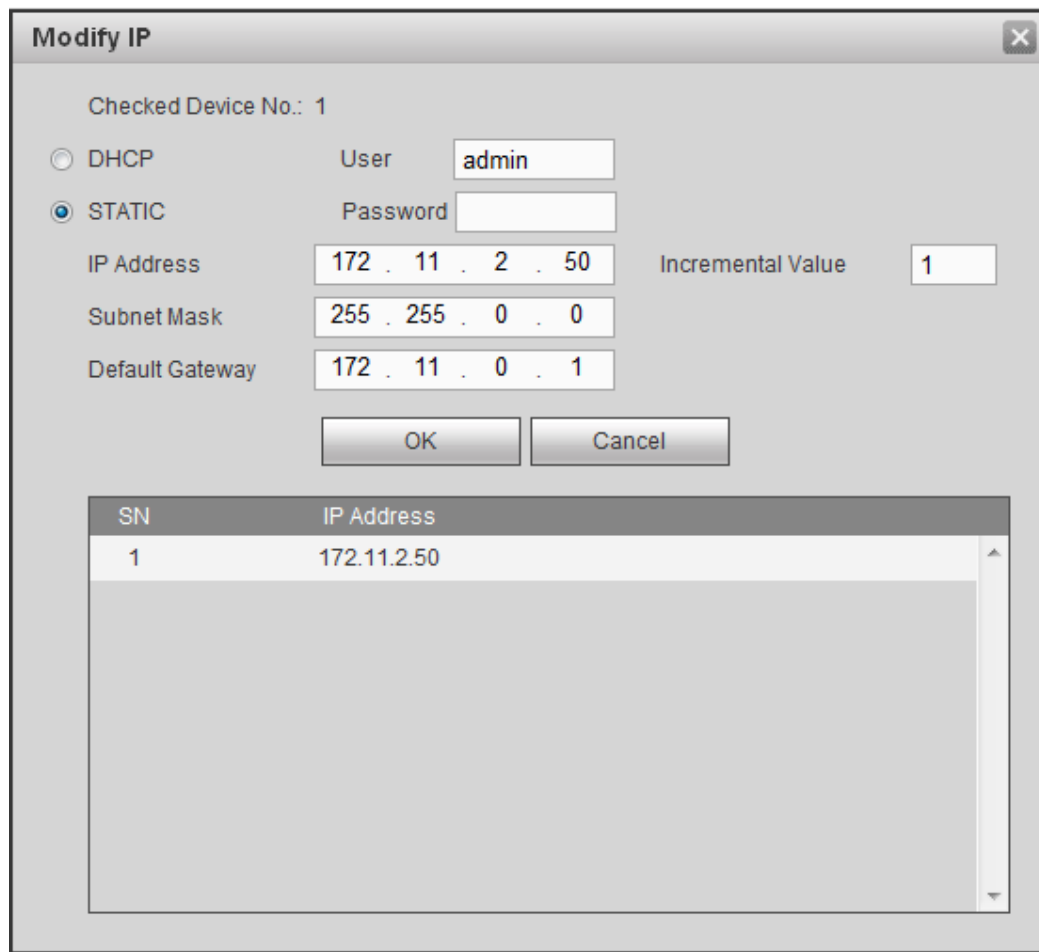

Figure 4-21

**Export IP**

User may export the list of the added devices to your local PC. Click Export button and then select the saved path. Click OK. User may see “Backup completed ” prompt.

**Note**

The export file extension name is .CVS. The file contains IP address, port, remote channel No.

manufacturer, user name, password and etc.

### Import IP

User may import the added device list to add the device conveniently. Click Import button, and then select the import file.

#### Note

If the imported IP is already in the added device list, system pops up dialogue box for you to confirm overwrite or not.

- Click OK button, the new IP setup can overwrite the new one.
- Click Cancel button, system adds the new IP setup.



#### Important

- User may edit the exported file. Please make sure the file format is the same. Otherwise user may not import the file again!
- System does not support customized protocol import/export.
- The import/export function is for the devices of the same language.

#### 4.8.1.1.2 Upgrade

#### Important

**This function is for online network camera only.**

From main window->Setup->Camera->Remote device->Upgrade, user may see an interface is shown as below. See Figure 4-22.

Check the network camera you want to upgrade and then click Browse button to select upgrade file. Click Start upgrade button to begin the process.

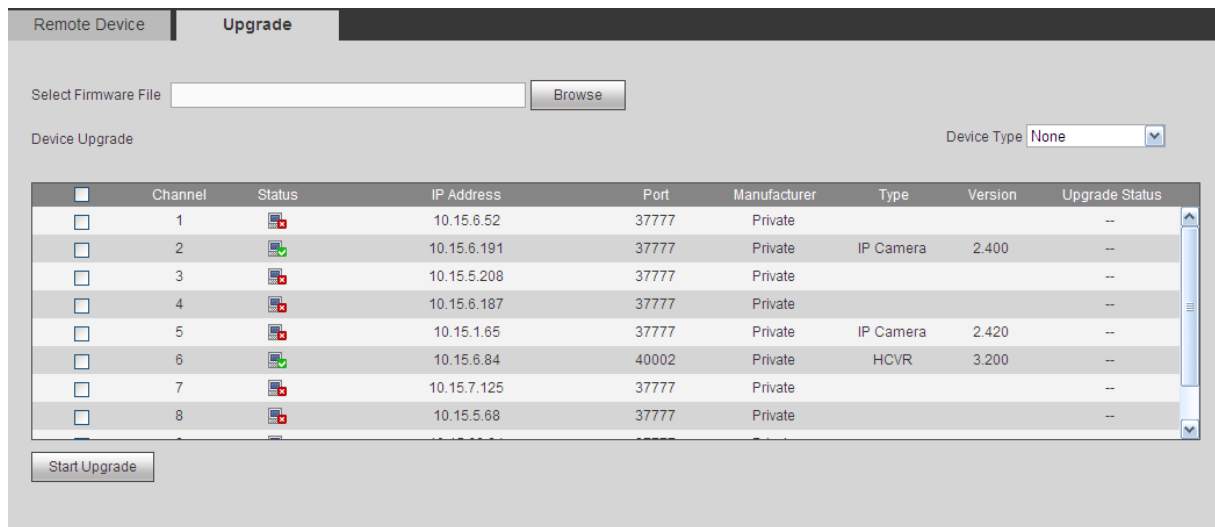

Figure 4-22

#### Tips

User may use filter to select several network cameras at the same time.

#### 4.8.1.2 Image

From main window->Setup->Camera->Image, user may see an interface shown as in Figure 4-23.

Here user may view device property information. The setups become valid immediately after you set.

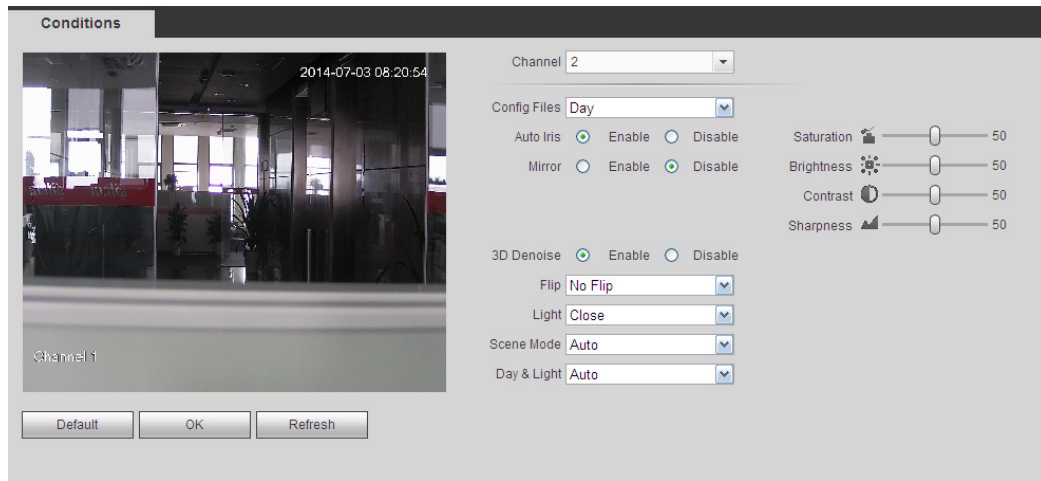

Figure 4-23

Please refer to the following sheet for detailed information.

Parameter	Function
Channel	Please select a channel from the dropdown list.
Config file	The options includes: day/night/general/switch by period. Once the mode is switch by period, user may set sunset and sunrise time.
3D NR	It is to process multiple-frame (At least two frames). System uses the information between these two frames to realize noise reduction function.
Hue	It is to adjust monitor video brightness and darkness level. The default value is 50. The bigger the value is, the large the contrast between the bright and dark section is and vice versa.
Brightness	It is to adjust monitor window brightness. The default value is 50. The larger the number is , the bright the video is. When you input the value here, the bright section and the dark section of the video will be adjusted accordingly. User may use this function when the whole video is too dark or too bright. Please note the video may become hazy if the value is too high. The value ranges from 0 to 100.The recommended value ranges from 40 to 60.
Contrast	It is to adjust monitor window contrast. The value ranges from 0 to 100. The default value is 50. The larger the number is, the higher the contrast is. User may use this function when the whole video bright is OK but the contrast is not proper. Please note the video may become hazy if the value is too low. If this value is too high, the dark section may lack brightness while the bright section may over



		exposure .The recommended value ranges from 40 to 60.
Saturation		It is to adjust monitor window saturation. The value ranges from 0 to 100. The default value is 50.  The larger the number is, the strong the color is. This value has no effect on the general brightness of the whole video. The video color may become too strong if the value is too high. For the grey part of the video, the distortion may occur if the white balance is not accurate. Please note the video may not be attractive if the value is too low. The recommended value ranges from 40 to 60.
Gain		The gain adjust is to set the gain value. The smaller the value is, the low the noise is. But the brightness is also too low in the dark environments. It can enhance the video brightness if the value is high. But the video noise may become too clear.
White level		It is to enhance video effect.
Color mode		It includes several modes such as standard, color. User may select corresponding color mode here, user may see hue, brightness, and contrast and etc will adjust accordingly.
Auto Iris		It is to enable/disable auto iris function.
Flip		It is to switch video up and bottom limit. This function is disabled by default.
Mirror		It is to switch video left and right limit. This function is disabled by default.
BLC Mode	BLC	The device auto exposures according to the environments situation so that the darkest area of the video is cleared
	WDR	For the WDR scene, this function can lower the high bright section and enhance the brightness of the low bright section. So that user may view these two sections clearly at the same time.  The value ranges from 1 to 100. When you switch the camera from no-WDR mode to the WDR mode, system may lose several seconds record video.
	HLC	After you enabled HLC function, the device can lower the brightness of the brightest section according to the HLC control level. It can reduce the area of the halo and lower the brightness of the whole video.
	Off	It is to disable the BLC function. Please note this function is disabled by default.
Profile		It is to set the white balance mode. It has effect on the general hue of the video. This function is on by default.  User may select the different scene mode such as auto, sunny, cloudy, home, office, night, disable and etc to adjust the video to the best quality.  <ul style="list-style-type: none"> <li>● Auto: The auto white balance is on. System can auto compensate the color temperature to make sure the vide color is proper.</li> <li>● Sunny: The threshold of the white balance is in the sunny mode.</li> </ul>

	<ul style="list-style-type: none"> <li>● Night: The threshold of the white balance is in the night mode.</li> <li>● Customized: User may set the gain of the red/blue channel. The value reneges from 0 to 100.</li> </ul>
Day/Night	<p>It is to set device color and the B/W mode switch. The default setup is auto.</p> <ul style="list-style-type: none"> <li>● Color: Device outputs the color video.</li> <li>● Auto: Device auto select to output the color or the B/W video according to the device feature (The general bright of the video or there is IR light or not.)</li> <li>● B/W: The device outputs the black and white video.</li> <li>● Sensor: It is to set when there is peripheral connected IR light.</li> </ul>

#### 4.8.1.3 Encode

##### 4.8.1.3.1 Encode

From main window->Setup->Camera->Encode->Encode, the encode interface is shown as below. See Figure 4-24.

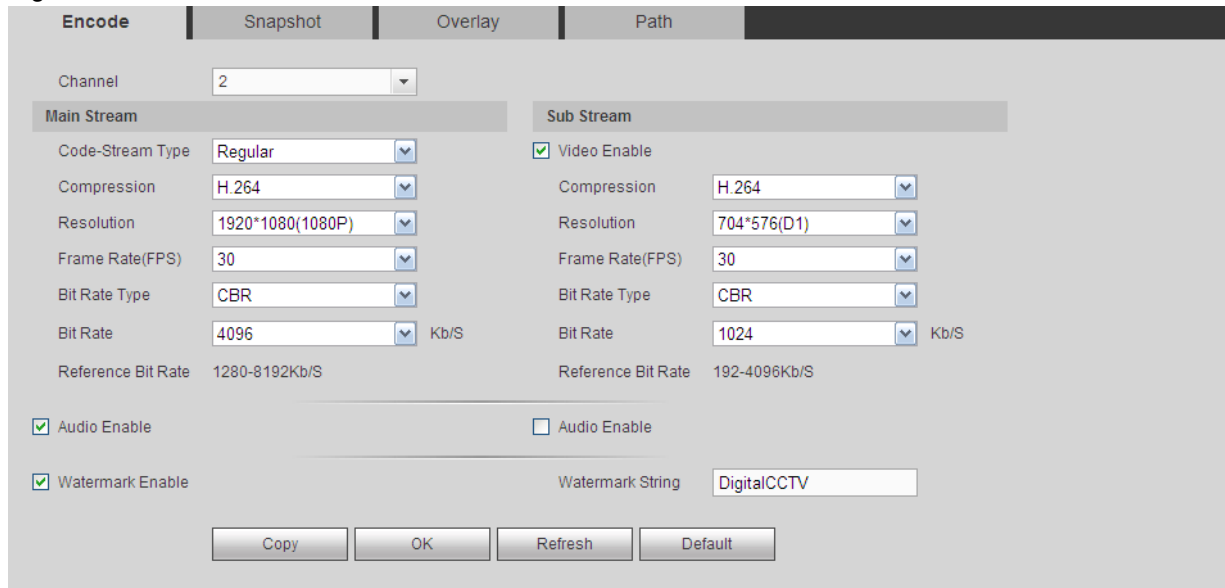

Figure 4-24

Please refer to the following sheet for detailed information.

Parameter	Function
Channel	Please select a channel from the dropdown list.
Video enable	Check the box here to enable extra stream video. This item is enabled by default.
Code stream type	<p>It includes main stream, motion stream and alarm stream. User may select different encode frame rates form different recorded events.</p> <p>System supports active control frame function (ACF). It allows you to record in different frame rates.</p> <p>For example, user may use high frame rate to record important events, record scheduled event in lower frame rate and it allows you to set different frame rates for motion detection record and</p>

	alarm record.
Compression	The main bit stream supports H.264. The extra stream supports H.264, MJPG.
Resolution	The resolution here refers to the capability of the network camera.
Frame Rate	PAL: 1~25f/s; NTSC: 1~30f/s.
Bit Rate	<ul style="list-style-type: none"> <li>● Main stream: User may set bit rate here to change video quality. The large the bit rate is, the better the quality is. Please refer to recommend bit rate for the detailed information.</li> <li>● Extra stream: In CBR, the bit rate here is the max value. In dynamic video, system needs to low frame rate or video quality to guarantee the value. The value is null in VBR mode.</li> </ul>
Reference bit rate	Recommended bit rate value according to the resolution and frame rate you have set.
I Frame	Here user may set the P frame amount between two I frames. The value ranges from 1 to 150. Default value is 50. Recommended value is frame rate *2.
Watermark enable	This function allows you to verify the video is tampered or not. Here user may select watermark bit stream, watermark mode and watermark character. Default character is DigitalCCTV. The max length is 85-digit. The character can only include number, character and underline.

#### 4.8.1.3.2 Snapshot

From main window->Setup->Camera->Encode->Snapshot, the snapshot interface is shown as in Figure 4-25.

Figure 4-25

Please refer to the following sheet for detailed information.

Parameter	Function
Mode	There are two modes: Regular (schedule) and timing (Trigger).

	<ul style="list-style-type: none"> <li>● Regular snapshot is valid during the specified period you set.</li> <li>● Trigger snapshot only is valid when motion detect alarm, tampering alarm or local activation alarm occurs.</li> </ul>
Image size	It is the same with the resolution of the main stream.
Quality	It is to set the image quality. There are six levels.
Interval	It is to set snapshot frequency. The value ranges from 1s to 7s. Or user may set customized value. The max setup is 3600s/picture.

#### 4.8.1.3.3 Video Overlay

From main window->Setup->Camera->Encode->Overlay, the video overlay interface is shown as in Figure 4-26.

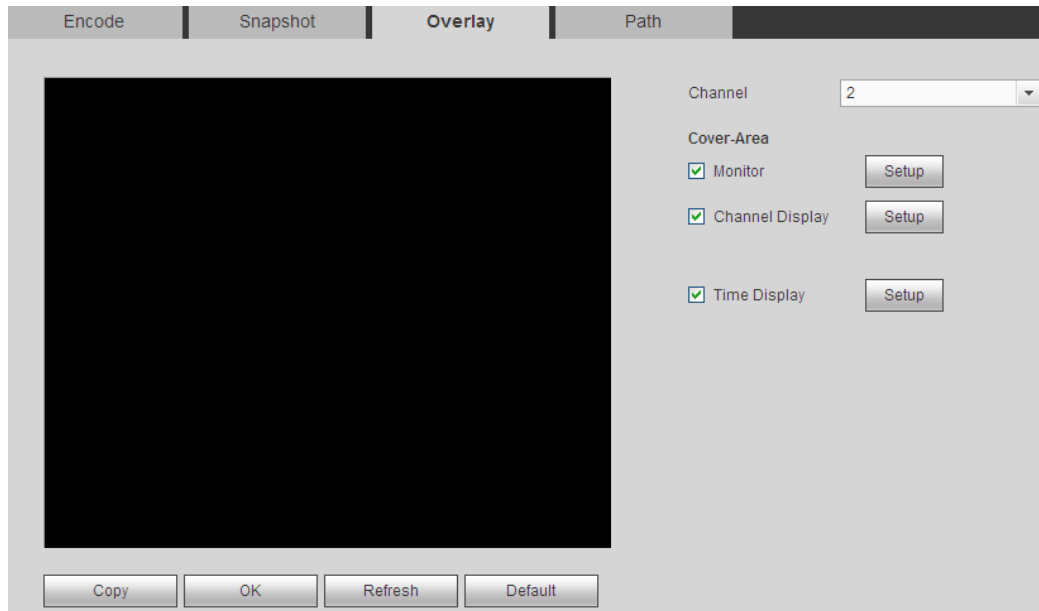



Figure 4-26

Please refer to the following sheet for detailed information.

Parameter	Function
Cover-area	Check Preview or Monitor first. Click Setup button, user may privacy mask the specified video in the preview or monitor video. System max supports 4 privacy mask zones.
Time Title	User may enable this function so that system overlays time information in video window. User may use the mouse to drag the time title position. User may view time title on the live video of the WEB or the playback video.
Channel Title	User may enable this function so that system overlays channel information in video window. User may use the mouse to drag the channel title position. User may view channel title on the live video of the WEB or the playback video.

#### 4.8.1.3.4 Path

From main window->Setup->Camera->Encode->Path, the storage path interface is shown as in Figure 4-27.

Here user may set snap image saved path (  in the preview interface) and the record storage path (  in the preview interface). The default setup is C:\PictureDownload and C:\RecordDownload. Please click the Save button to save current setup.

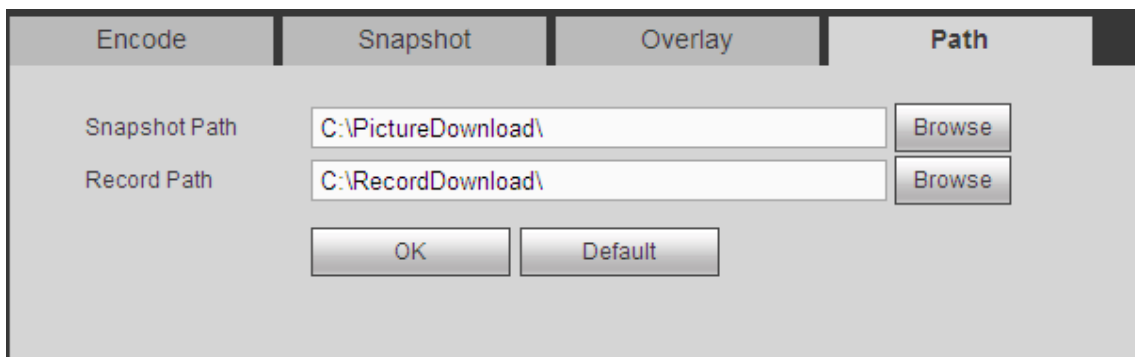

Figure 4-27

#### 4.8.1.4 Camera Name

From main window->Setup->Camera->Camera name, here user may set channel name. See Figure 4-28.

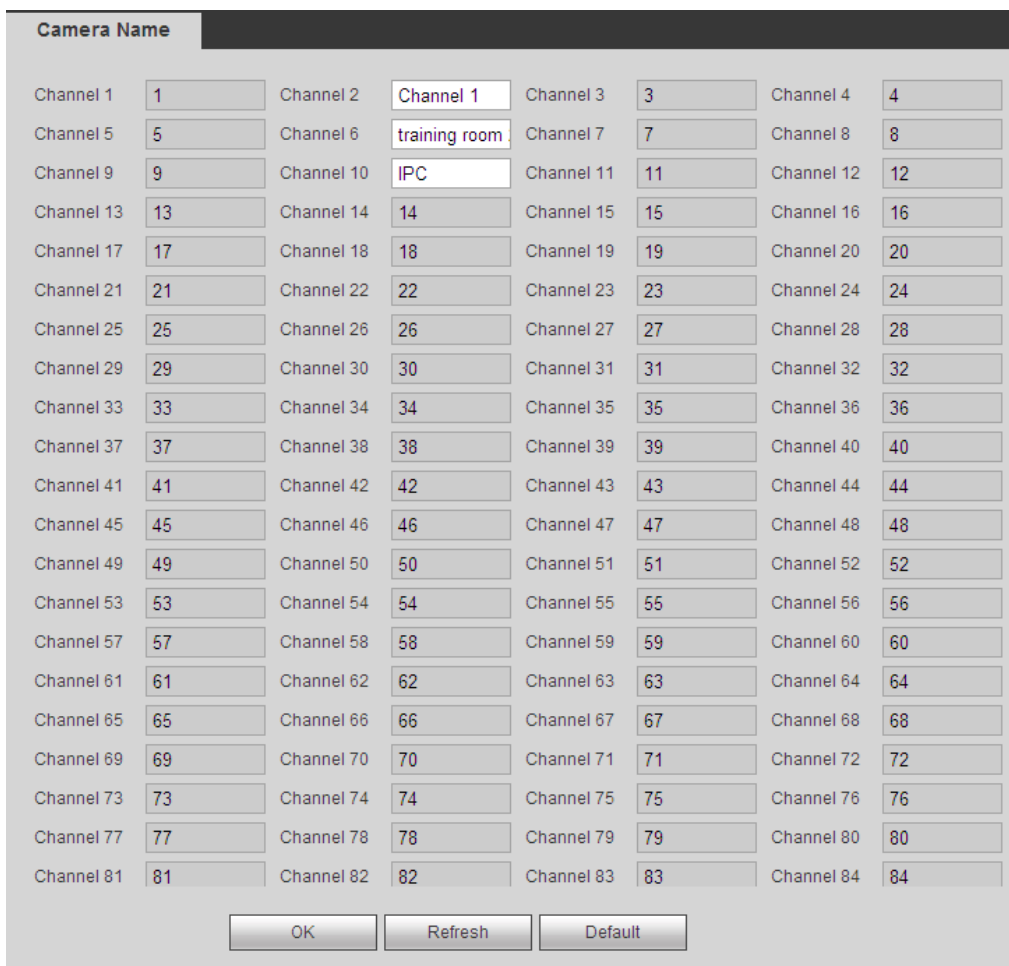

Figure 4-28

## 4.8.2 Network

### 4.8.2.1 TCP/IP

From main window->Setup->Network->TCP/IP, the TCP/IP interface is shown as in Figure 4-29.

Figure 4-29

Parameter	Function
IP Version	It is to select IP version. IPV4 or IPV6. User may access the IP address of these two versions.
Default card	Select Ethernet card name if you network mode is fault tolerance.
Preferred DNS	DNS IP address.
Alternate DNS	Alternate DNS IP address.
<b>For the IP address of IPv6 version, default gateway, preferred DNS and alternate DNS, the input value shall be 128-digit. It shall not be left in blank.</b>	
LAN load	System can process the downloaded data first if you enable this function. The download speed is 1.5X or 2.0X of the normal speed.

Click Edit button , user may go to the following interface. See Figure 4-30.

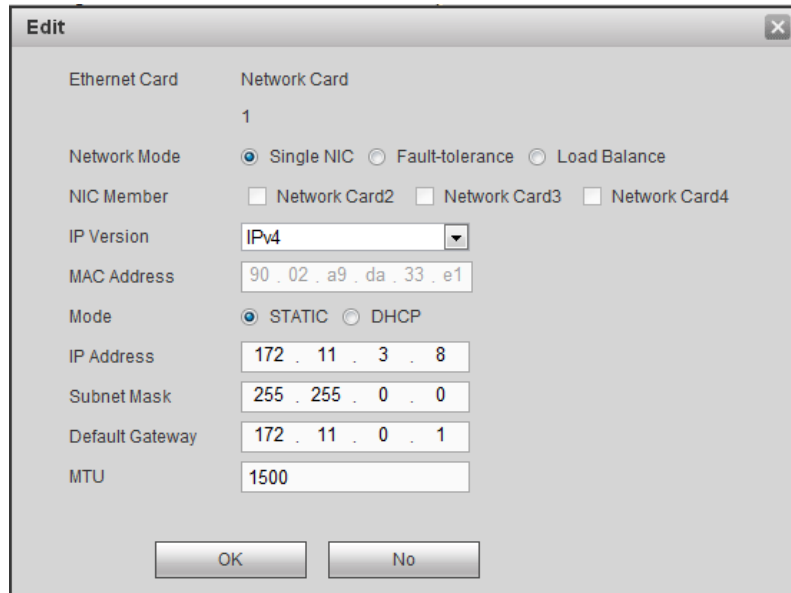

Figure 4-30

Please refer to the following sheet for detailed information.

Parameter	Function
Network mode	<p>It includes: single NIC, fault tolerance, load balance.</p> <ul style="list-style-type: none"> <li>● Single NIC: eth1/eth2/ eth3/eth4 operate separately. User may use the services such as HTTP, RTP service via eth1/eth2/ eth3/eth4. Usually you need to set one default card (default setup is eth1) to request the auto network service from the device-end such as DHCP, email, FTP and etc. In multiple-address mode, system network status is shown as offline once one card is offline.</li> <li>● Fault-tolerance: In this mode, device uses bond0 to communicate with the external devices. User may focus on one host IP address. At the same time, you need to set one master card. Usually there is only one running card (master card).System can enable alternate card when the master card is malfunction. The system is shown as offline once all cards are offline. Please note all cards shall be in the same LAN.</li> <li>● Load balance: In this mode, device uses bond0 to communicate with the external device. The all cards are working now and bearing the network load. Their network load are general the same. The system is shown as offline once all cards are offline. Please note all cards shall be in the same LAN.</li> </ul>
NIC member	<p>User may check the box here to select the bind cards.</p> <ul style="list-style-type: none"> <li>● This mode is for fault-tolerance or load balance mode only.</li> <li>● The network cards number shall be equal to or more than 2.</li> <li>● The different types of cards such as fiber card or the Ethernet card can not binding together.</li> </ul>

IP address	Here user may use up/down button (▲▼) or input the corresponding number to input IP address. Then user may set the corresponding subnet mask the default gateway.
Mac Address	It is to display host Mac address.
IP Version	It is to select IP version. IPV4 or IPV6. User may access the IP address of these two versions.
Default gateway	Here user may input the default gateway. Please note system needs to check the validity of all IPv6 addresses. The IP address and the default gateway shall be in the same IP section. That is to say, the specified length of the subnet prefix shall have the same string.
DHCP	It is to auto search IP. When enable DHCP function, user may not modify IP/Subnet mask /Gateway. These values are from DHCP function. If you have not enabled DHCP function, IP/Subnet mask/Gateway display as zero. You need to disable DHCP function to view current IP information. Besides, when PPPoE is operating, user may not modify IP/Subnet mask /Gateway.
MTU	<p>It is to set MTU value of the network adapter. The value ranges from 1280-7200 bytes. The default setup is 1500 bytes. Please note MTU modification may result in network adapter reboot and network becomes off. That is to say, MTU modification can affect current network service. System may pop up dialog box for you to confirm setup when you want to change MTU setup. Click OK button to confirm current reboot, or user may click Cancel button to terminate current modification. Before the modification, user may check the MTU of the gateway; the MTU of the NVR shall be the same as or is lower than the MTU of the gateway. In this way, user may reduce packets and enhance network transmission efficiency. Right now, the value here is for read-only.</p> <p>The following MTU value is for reference only.</p> <ul style="list-style-type: none"> <li>● 1500: Ethernet information packet max value and it is also the default value. It is the typical setup when there is no PPPoE or VPN. It is the default setup of some router, switch or the network adapter.</li> <li>● 1492: Recommend value for PPPoE.</li> <li>● 1468: Recommend value for DHCP.</li> </ul>

#### 4.8.2.2 Connection

From main window->Setup->Network->Connection, the connection interface is shown as in Figure 4-31.



**CONNECTION**

Max Connection  (0~128)

TCP Port  (1025~65535)

UDP Port  (1025~65535)

HTTP Port  (1~65535)

HTTPS Port  (1~65535)

RTSP Port  (1~65535)

RTSP Format rtsp://<User Name>:<Password>@<IP Address>:<Port>/cam/realmonitor?channel=1&subtype=0  
channel: Channel, 1-128; subtype: Code-Stream Type, Main Stream 0, Sub Stream 1.

Figure 4-31

Please refer to the following sheet for detailed information.

Parameter	Function
Max connection	It is the max Web connection for the same device. The value ranges from 1 to 120. The default setup is 120.
TCP port	The default value is 37777. User may input the actual port number if necessary.
UDP port	The default value is 37778. User may input the actual port number if necessary.
HTTP port	The default value is 80. User may input the actual port number if necessary.
HTTPS port	The default value is 443. User may input the actual port number if necessary.
RTSP port	The default value is 554.

#### 4.8.2.3 PPPoE

From main window->Setup->Network->PPPoE, the PPPoE interface is shown as in Figure 4-32.

Input the PPPoE user name and password you get from the IPS (internet service provider) and enable PPPoE function. Please save current setup and then reboot the device to get the setup activated.

Device connects to the internet via PPPoE after reboot. User may get the IP address in the WAN from the IP address column.

**Please note, you need to use previous IP address in the LAN to login the device. Please go to the IP address item to via the device current device information. User may access the client-end via this new address.**

Figure 4-32

#### 4.8.2.4 DDNS

From main window->Setup->Network->DDNS, the DDNS interface is shown as in Figure 4-33.

The DDNS is to set to connect the various servers so that user may access the system via the server. Please go to the corresponding service website to apply a domain name and then access the system via the domain. It works even your IP address has changed.

Please select DDNS from the dropdown list (Multiple choices). Before you use this function, please make sure your purchased device support current function.

Figure 4-33

Please refer to the following sheet for detailed information.

Parameter	Function
Server Type	User may select DDNS protocol from the dropdown list and then enable DDNS function.
Server IP	DDNS server IP address
Server Port	DDNS server port.
Domain Name	Your self-defined domain name.

Parameter	Function
User	The user name you input to log in the server.
Password	The password you input to log in the server.
Update period	Device sends out alive signal to the server regularly. User may set interval value between the device and DDNS server here.

## Quick DDNS and Client-end Introduction

### 1) Background Introduction

Device IP is not fixed if you use ADSL to login the network. The DDNS function allows you to access the NVR via the registered domain name. Besides the general DDNS, the quick DDNS works with the device from the manufacturer so that it can add the extension function.

### 2) Function Introduction

The quick DDNS client has the same function as other DDNS client end. It realizes the bonding of the domain name and the IP address. Right now, current DDNS server is for our own devices only. You need to refresh the bonding relationship of the domain and the IP regularly. There is no user name, password or the ID registration on the server. At the same time, each device has a default domain name (Generated by MAC address) for your option. User may also use customized valid domain name (has not registered.).

### 3) Operation

Before you use Quick DDNS, you need to enable this service and set proper server address, port value and domain name.

- Server address: [www.quickddns.com](http://www.quickddns.com)
- Port number: 80
- Domain name: There are two modes: Default domain name and customized domain name.

Except default domain name registration, user may also use customized domain name (User may input your self-defined domain name.) After successful registration, user may use domain name to login installed of the device IP.

- User name: It is optional. User may input your commonly used email address.

### Important

- Do not register frequently. The interval between two registrations shall be more than 60 seconds. Too many registration requests may result in server attack.
- System may take back the domain name that is idle for one year. User may get a notification email before the cancel operation if your email address setup is OK.

#### 4.8.2.5 IP filter

From main window->Setup->Network->IP filter, the IP filter interface is shown as in Figure 4-34.

After you enabled trusted sites function, only the IP listed below can access current NVR.

If you enable blocked sites function, the following listed IP addresses can not access current NVR.

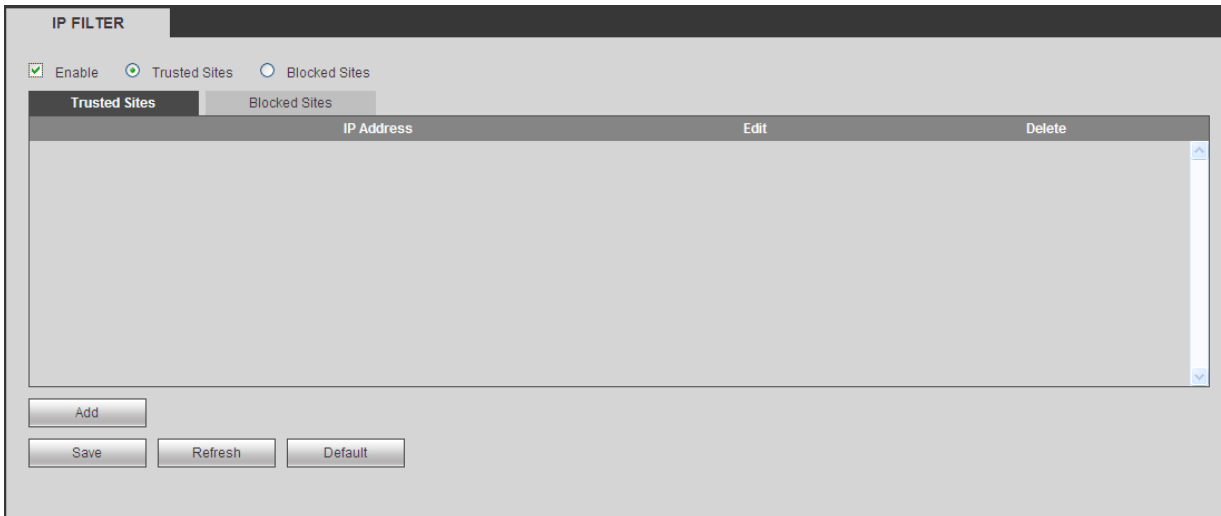

Figure 4-34

#### 4.8.2.6 Email

From main window->Setup->Network->Email, the email interface is shown as in Figure 4-35.

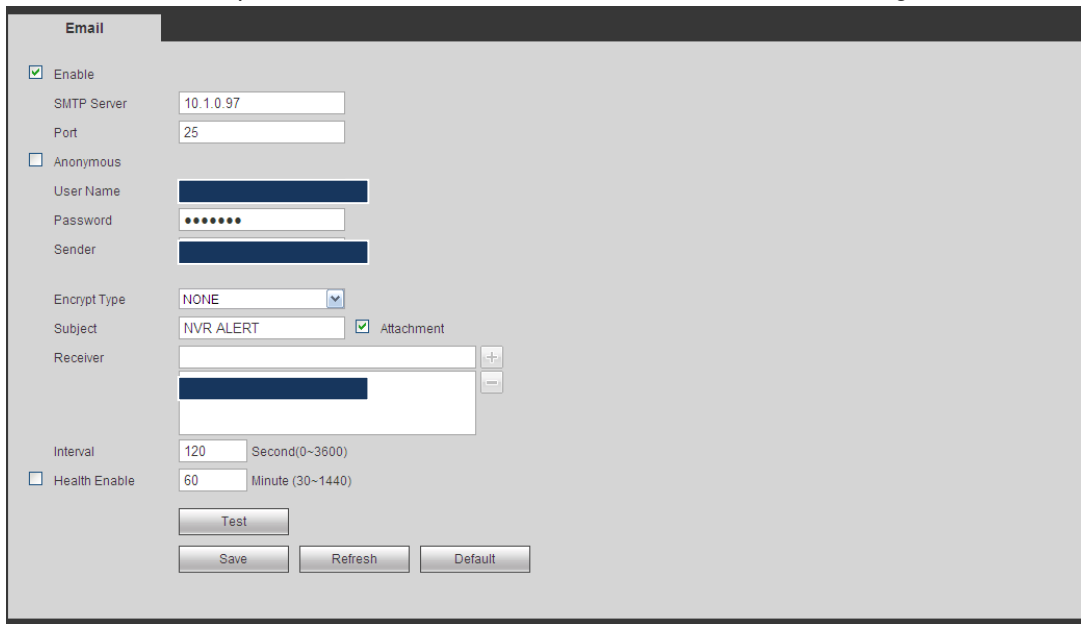

Figure 4-35

Please refer to the following sheet for detailed information.

Parameter	Function
Enable	Please check the box here to enable email function.
SMTP Server	Input server address and then enable this function.
Port	Default value is 25. User may modify it if necessary.
Anonymity	For the server supports the anonymity function. User may auto login anonymously. You do not need to input the user name, password and the sender information.

Parameter	Function
User Name	The user name of the sender email account.
Password	The password of sender email account.
Sender	Sender email address.
Authentication (Encryption mode)	User may select SSL or none.
Subject	Input email subject here.
Attachment	System can send out the email of the snapshot picture once you check the box here.
Receiver	Input receiver email address here. Max three addresses. It supports SSL, TLS email box.
Interval	The send interval ranges from 0 to 3600 seconds. 0 means there is no interval. Please note system will not send out the email immediately when the alarm occurs. When the alarm, motion detection or the abnormality event activates the email, system sends out the email according to the interval you specified here. This function is very useful when there are too many emails activated by the abnormality events, which may result in heavy load for the email server.
Health mail enable	Please check the box here to enable this function.
Update period (interval)	This function allows the system to send out the test email to check the connection is OK or not. Please check the box to enable this function and then set the corresponding interval. System can send out the email regularly as you set here.
Email test	The system will automatically sent out an email once to test the connection is OK or not .Before the email test, please save the email setup information.

#### 4.8.2.7 FTP

From main window->Setup->Network->FTP, the FTP interface is shown as in Figure 4-36.

It is to set FTP IP, port and etc for remote storage.

Figure 4-36

#### 4.8.2.8 UPnP

From main window->Setup->Network->UPnP, here user may also add, modify or remove UPnP item. See Figure 4-37.

It allows you to establish the mapping relationship between the LAN and the public network.

- In the Windows OS, From Start->Control Panel->Add or remove programs. Click the “Add/Remove Windows Components” and then select the “Network Services” from the Windows Components Wizard.
- Click the Details button and then check the “Internet Gateway Device Discovery and Control client” and “UPnP User Interface”. Please click OK to begin installation.
- Enable UPnP from the Web. If your UPnP is enabled in the Windows OS, the NVR can auto detect it via the “My Network Places”

**UPNP**

PAT  Enable  Disable

Status Disable

LAN IP

WAN IP

Port Mapping List							
No.	<input checked="" type="checkbox"/>	Service Name	Protocol	Internal Port	External Port	Modify	Delete
1	<input checked="" type="checkbox"/>	HTTP	TCP	80	80		
2	<input checked="" type="checkbox"/>	TCP	TCP	37777	37777		
3	<input checked="" type="checkbox"/>	UDP	UDP	37778	37778		
4	<input checked="" type="checkbox"/>	RTSP	UDP	554	554		
5	<input checked="" type="checkbox"/>	RTSP	TCP	554	554		
6	<input checked="" type="checkbox"/>	SNMP	UDP	161	161		
7	<input checked="" type="checkbox"/>	HTTPS	TCP	443	443		

Figure 4-37

#### 4.8.2.9 SNMP

From main window->Setup->Network->SNMP, the SNMP interface is shown as in Figure 4-38.

The SNMP allows the communication between the network management work station software and the proxy of the managed device. It is reserved for the 3<sup>rd</sup> party to develop.

**SNMP V1/V2**

Enable

SNMP Port  (0~65535)

Read Community

Write Community

Trap Address

Trap Port  (0~65535)

Version  V1  V2

Figure 4-38

Please refer to the following sheet for detailed information.

Parameter	Function
SNMP Port	The listening port of the proxy program of the device. It is a UDP port not a TCP port. The value ranges from 1 to 65535. The default value is 161

Parameter	Function
Read Community	It is a string. It is a command between the manage process and the proxy process. It defined the authentication, access control and the management relationship between one proxy and one group of the managers. Please make sure the device and the proxy are the same. The read community will read all the objects the SNMP supported in the specified name. The default setup is public.
Write Community	It is a string. It is a command between the manage process and the proxy process. It defined the authentication, access control and the management relationship between one proxy and one group of the managers. Please make sure the device and the proxy are the same. The read community will read/write/access all the objects the SNMP supported in the specified name. The default setup is write.
Trap address	The destination address of the Trap information from the proxy program of the device.
Trap port	The destination port of the Trap information from the proxy program of the device. It is for the gateway device and the client-end PC in the LAN to exchange the information. It is a non-protocol connection port. It has no effect on the network applications. It is a UDP port not TCP port. The value ranges from 1 to 165535. The default value is 162.
SNMP version	<ul style="list-style-type: none"> <li>● Check V1, system only processes the information of V1.</li> <li>● Check V2, system only processes the information of V2.</li> </ul>

#### 4.8.2.10 Multicast

From main window->Setup->Network->Multicast, the multicast interface is shown as in Figure 4-39.

Multicast is a transmission mode of data packet. When there is multiple-host to receive the same data packet, multiple-cast is the best option to reduce the broad width and the CPU load. The source host can just send out one data to transit. This function also depends on the relationship of the group member and group of the outer.

Figure 4-39

#### 4.8.2.11 Register

From main window->Setup->Network->Register, the auto register interface is shown as below. See Figure 4-40.

This function allows the device to auto register to the proxy you specified. In this way, user may use the client-end to access the NVR and etc via the proxy. Here the proxy has a switch function. In the network



service, device supports the server address of IPv4 or domain.

Please follow the steps listed below to use this function.

Please set proxy server address, port, and sub-device name at the device-end. Please enable the auto register function, the device can auto register to the proxy server.

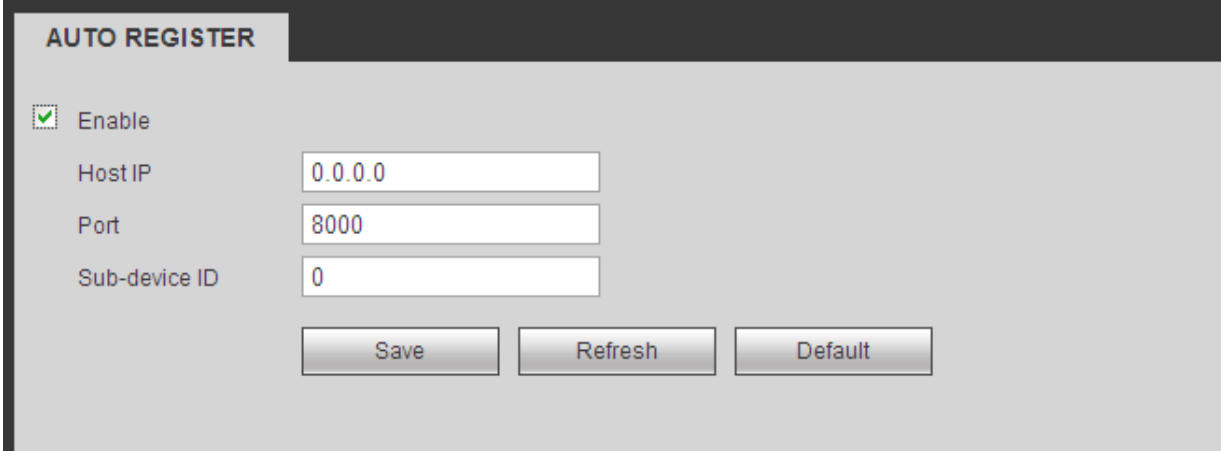

**AUTO REGISTER**

Enable

Host IP: 0.0.0.0

Port: 8000

Sub-device ID: 0

Save Refresh Default

Figure 4-40

#### 4.8.2.12 Alarm Centre

From main window->Setup->Network->Alarm centre, the alarm center interface is shown as below. See Figure 4-41.

This interface is reserved for you to develop. System can upload alarm signal to the alarm center when local alarm occurs.

Before you use alarm center, please set server IP, port and etc. When an alarm occurs, system can send out data as the protocol defined, so the client-end can get the data.

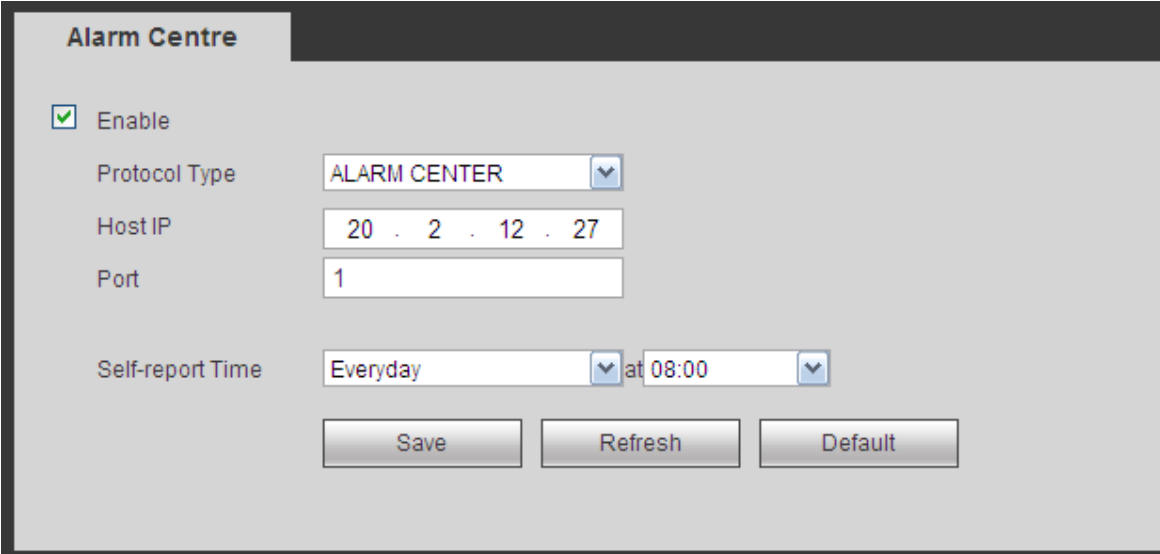

**Alarm Centre**

Enable

Protocol Type: ALARM CENTER

Host IP: 20 . 2 . 12 . 27

Port: 1

Self-report Time: Everyday at 08:00

Save Refresh Default

Figure 4-41

#### 4.8.2.13 HTTPS

From main window->Setup->Network->HTTPS, user may see an interface shown as in Figure 4-42. In this interface, user may set to make sure the PC can successfully login via the HTTPS. It is to guarantee

communication data security. The reliable and stable technology can secure the user information security and device safety.

**Note**

- You need to implement server certificate again if you have changed device IP.
- You need to download root certificate if it is your first time to use HTTPS on current PC.

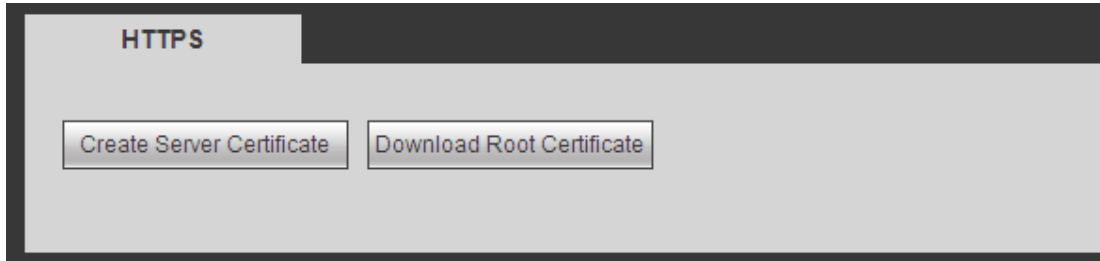
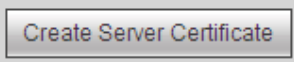

Figure 4-42

4.8.2.13.1 Create Server Certificate

If it is your first time to use this function, please follow the steps listed below.

In Figure 4-42, click  button, input country name, state name and etc. Click Create button. See Figure 4-43.

**Note**

Please make sure the IP or domain information is the same as your device IP or domain name.

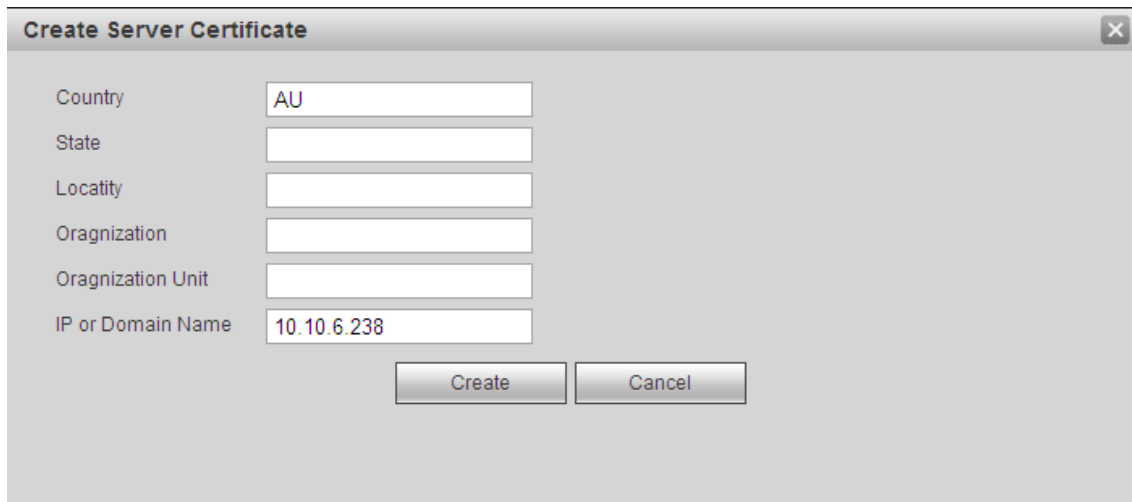

Figure 4-43

User may see the corresponding prompt. See Figure 4-44. Now the server certificate is successfully created.



Figure 4-44

4.8.2.13.2 Download root certificate

In Figure 4-42, click **Download Root Certificate** button, system pops up a dialogue box. See Figure 4-45.



Figure 4-45

Click Open button, user may go to the following interface. See Figure 4-46.

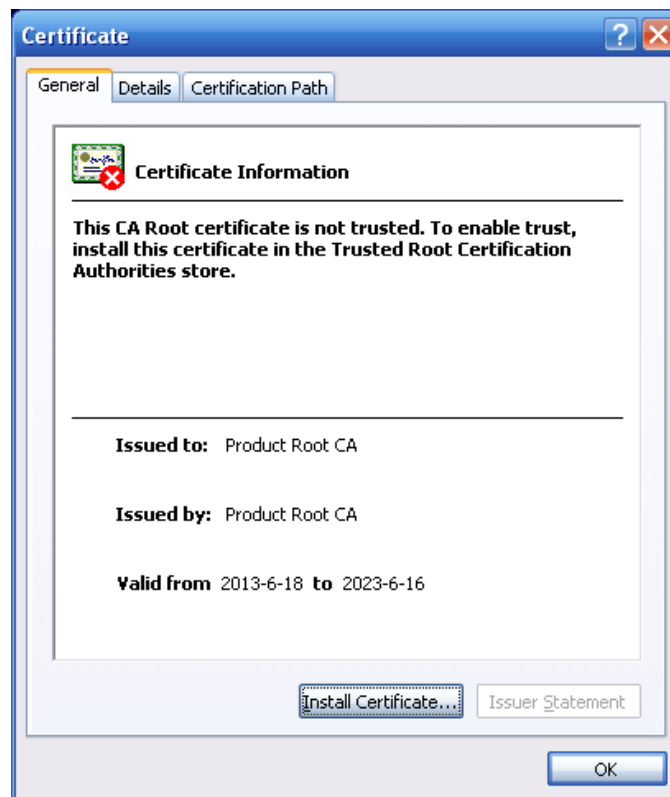

Figure 4-46

Click Install certificate button, user may go to certificate wizard. See Figure 4-47.



Figure 4-47

Click Next button to continue. Now user may select a location for the certificate. See Figure 4-48.

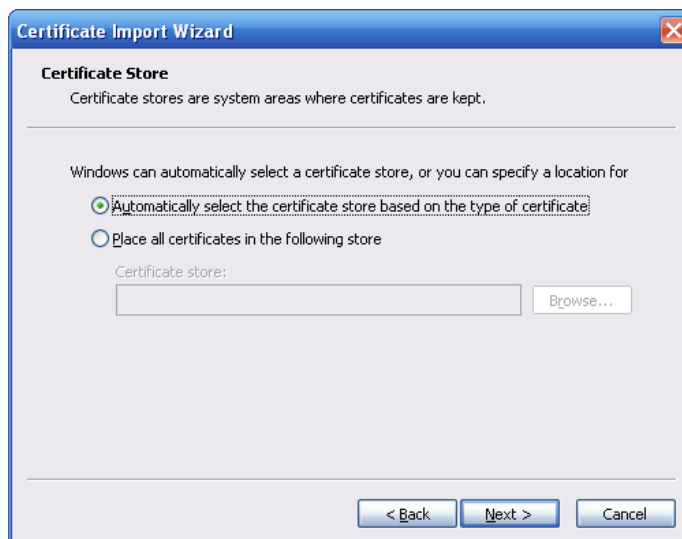

Figure 4-48

Click Next button, user may see the certificate import process is complete. See Figure 4-49.



Figure 4-49

Click Finish button, user may see system pops up a security warning dialogue box. See Figure 4-50.

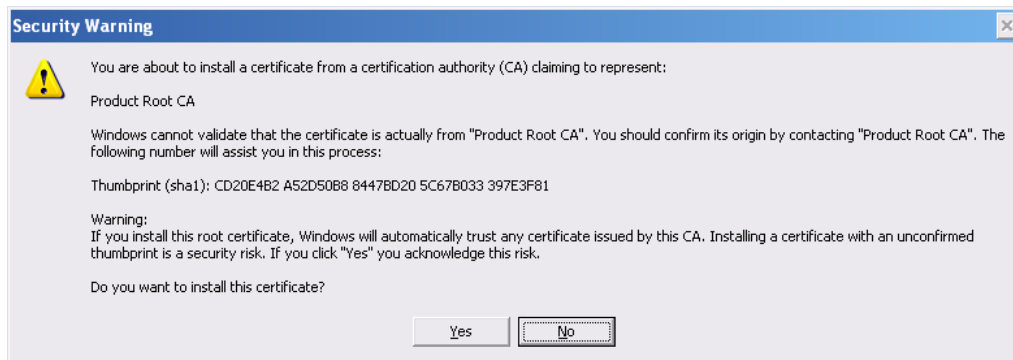

Figure 4-50

Click Yes button, system pops up the following dialogue box, user may see the certificate download is complete. See Figure 4-51.



Figure 4-51

#### 4.8.2.13.3 View and set HTTPS port

From Setup->Network->Connection, user may see the following interface. See Figure 4-52. User may see HTTPS default value is 443.

CONNECTION		
Max Connection	<input type="text" value="20"/>	(0~128)
TCP Port	<input type="text" value="37777"/>	(1025~65535)
UDP Port	<input type="text" value="37778"/>	(1025~65535)
HTTP Port	<input type="text" value="80"/>	(1~65535)
HTTPS Port	<input type="text" value="443"/>	(1~65535)
RTSP Port	<input type="text" value="554"/>	(1~65535)
RTSP Format	rtsp://<User Name>:<Password>@<IP Address>:<Port>/cam/realmonitor?channel=1&subtype=0 channel: Channel, 1-128; subtype: Code-Stream Type, Main Stream 0, Sub Stream 1.	
<input type="button" value="OK"/> <input type="button" value="Refresh"/> <input type="button" value="Default"/>		

Figure 4-52

#### 4.8.2.13.4 Login

Open the browser and then input <https://xx.xx.xx.xx:port>.

xx.xx.xx.xx: is your device IP or domain name.

Port is your HTTPS port. If you are using default HTTPS value 443, you do not need to add port information here. User may input <https://xx.xx.xx.xx> to access.

Now user may see the login interface if your setup is right.

### 4.8.3 Event

#### 4.8.3.1 Video detect

##### 4.8.3.1.1 Motion Detect

After analysis video, system can generate a video loss alarm when the detected moving signal reached the sensitivity you set here.

From main window->Setup->Event->Video detect->Motion detect, the motion detect interface is shown as in Figure 4-53.

**Motion Detect** | Video Loss | Tampering | Scene Change | Video Analytics

Enable      1 ▾

Period     

Anti-dither      0      s(0-600)

Region     

---

Record Channel     

Delay      10      s(10~300)

Alarm Out      1 2 3 4 5 6 7 8

Latch      0      s(0~300)

PTZ Activation     

Tour     

Snapshot     

Show Message       Send Email       Alarm Upload       Buzzer       Log

Figure 4-53

**Setup** [X]

Thursday ▾     

<input checked="" type="checkbox"/>	00 : 00	-	24 : 00
<input type="checkbox"/>	00 : 00	-	24 : 00
<input type="checkbox"/>	00 : 00	-	24 : 00
<input type="checkbox"/>	00 : 00	-	24 : 00
<input type="checkbox"/>	00 : 00	-	24 : 00
<input type="checkbox"/>	00 : 00	-	24 : 00

Figure 4-54

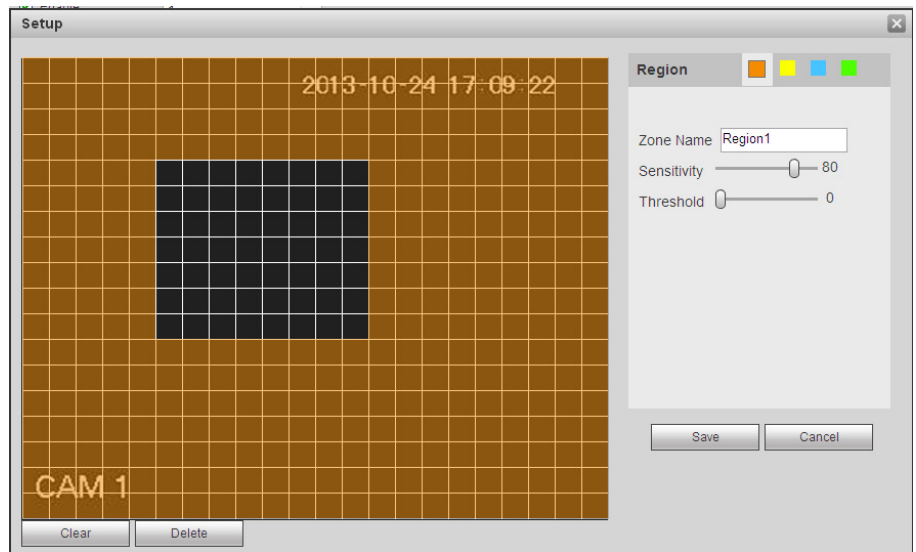

Figure 4-55

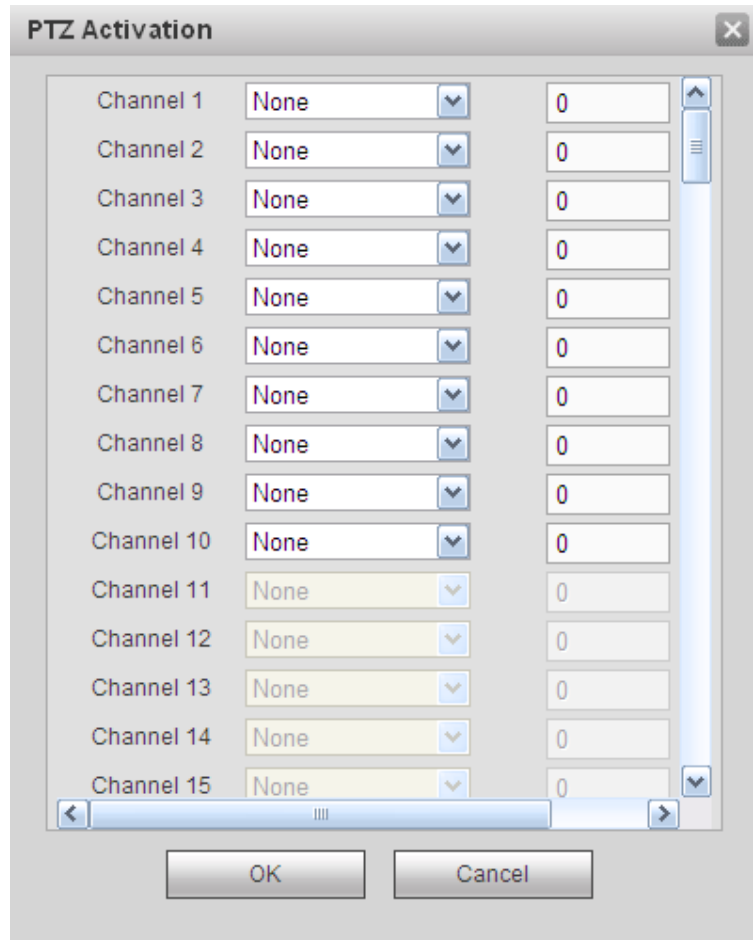

Figure 4-56



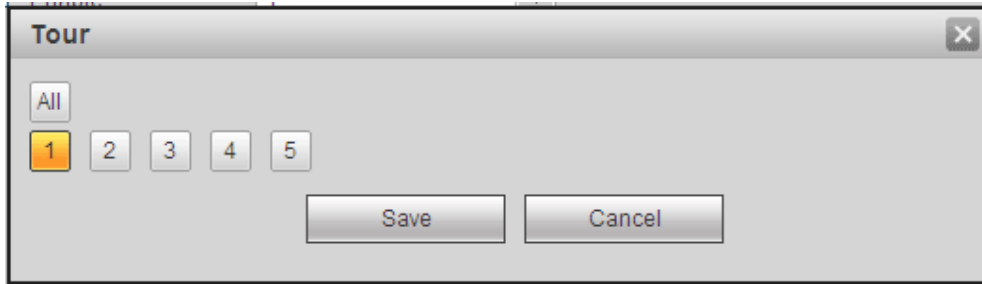

Figure 4-57

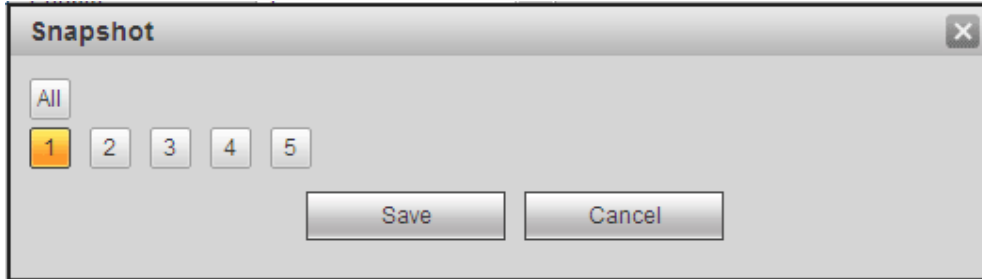

Figure 4-58

Please refer to the following sheet for detailed information.

Parameter	Function
Enable	You need to check the box to enable motion detection function. Please select a channel from the dropdown list.
Period	Motion detection function becomes activated in the specified periods. See Figure 4-54. There are six periods in one day. Please draw a circle to enable corresponding period. Click OK button, system goes back to motion detection interface, please click save button to exit.
Anti-dither	System only memorizes one event during the anti-dither period. The value ranges from 5s to 600s.
Sensitivity	There are six levels. The sixth level has the highest sensitivity.
Region	If you select motion detection type, user may click this button to set motion detection zone. The interface is shown as in Figure 4-55. Here user may set motion detection zone. There are four zones for you to set. Please select a zone first and then left drag the mouse to select a zone. The corresponding color zone displays different detection zone. User may click Fn button to switch between the arm mode and disarm mode. In arm mode, user may click the direction buttons to move the green rectangle to set the motion detection zone. After you completed the setup, please click ENTER button to exit current setup. Do remember click save button to save current setup. If you click ESC button to exit the region setup interface system will not save your zone setup.
Record channel	System auto activates motion detection channel(s) to record once an alarm occurs. Please note you need to set motion detect record

Parameter	Function
	period and go to Storage-> Schedule to set current channel as schedule record.
Record Delay	System can delay the record for specified time after alarm ended. The value ranges from 10s to 300s.
Alarm out	Enable alarm activation function. You need to select alarm output port so that system can activate corresponding alarm device when an alarm occurs.
Latch	System can delay the alarm output for specified time after an alarm ended. The value ranges from 1s to 300s.
Show message	System can pop up a message to alarm you in the local host screen if you enabled this function.
Buzzer	Check the box here to enable this function. The buzzer beeps when an alarm occurs.
Alarm upload	System can upload the alarm signal to the centre (Including alarm centre).
Message	When 3G network connection is OK, system can send out a message when motion detect occurs.
Send Email	If you enabled this function, System can send out an email to alert you when an alarm occurs.
Tour	You need to click setup button to select tour channel. System begins 1-window or multiple-window tour display among the channel(s) you set to record when an alarm occurs. See Figure 4-57.
PTZ Activation	Here user may set PTZ movement when an alarm occurs. Such as go to preset X. See Figure 4-56.
Snapshot	Click setup button to select snapshot channel. See Figure 4-58.

#### 4.8.3.1.2 Video Loss

From main window->Setup->Event->Video detect->Video loss, the video loss interface is shown as in Figure 4-59.

Please note video loss does not support anti-dither, sensitivity, region setup. For rest setups, please refer to chapter 4.8.3.1.1 motion detect for detailed information.

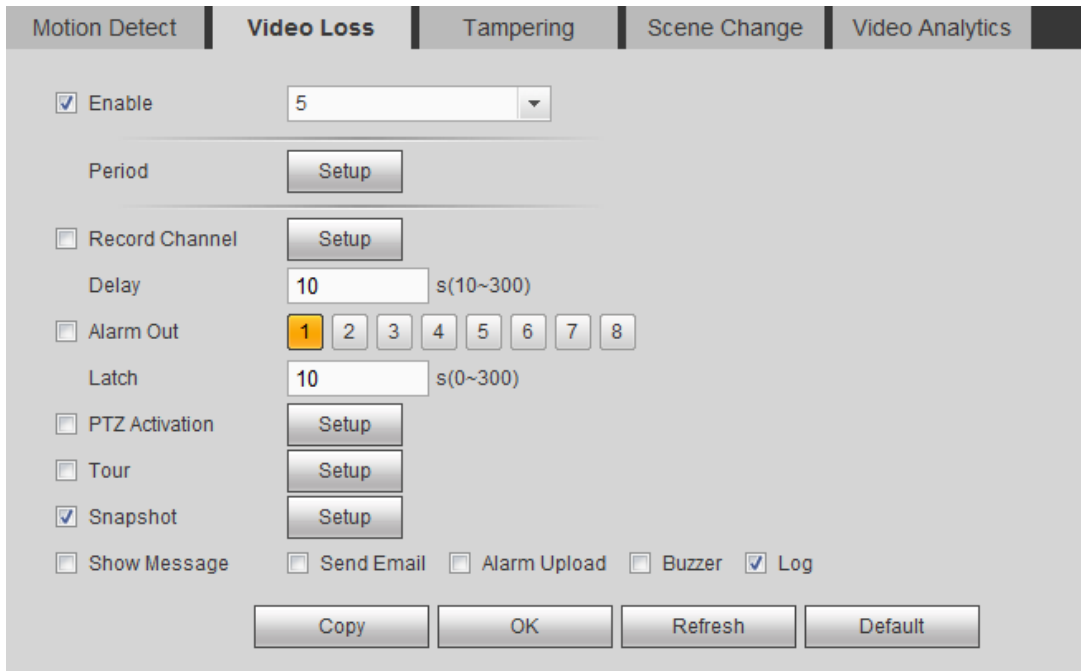

Figure 4-59

#### 4.8.3.1.3 Tampering

From main window->Setup->Event->Video detect->Tampering, the tampering interface is shown as in Figure 4-60.

After analysis video, system can generate a tampering alarm when the detected moving signal reached the sensitivity you set here.

For detailed setups, please refer to chapter 4.8.3.1.1 motion detect for detailed information.

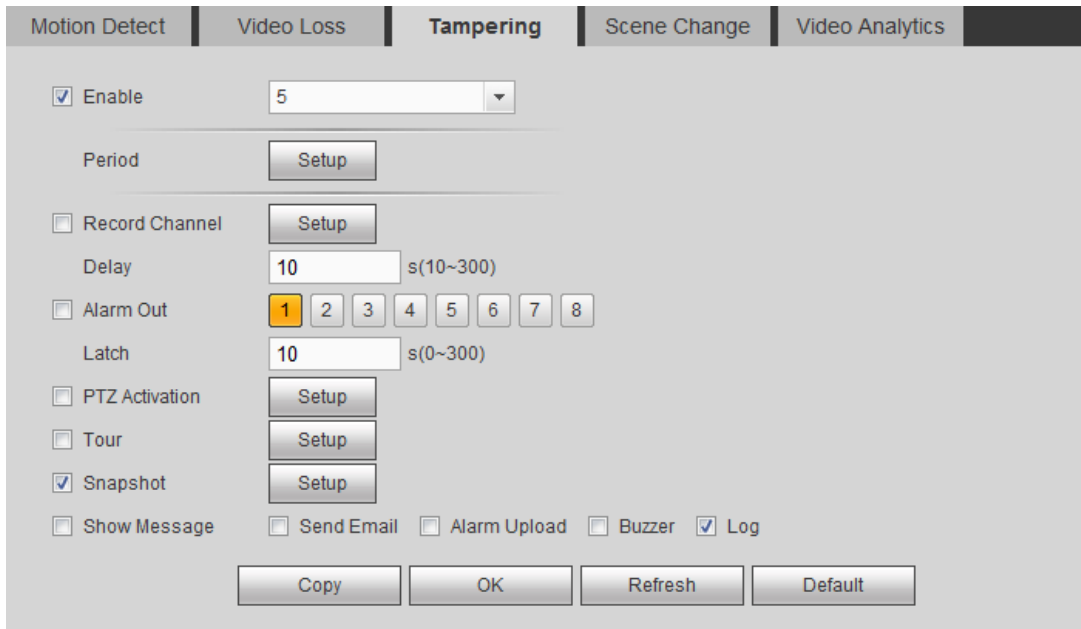

Figure 4-60

#### 4.8.3.1.4 Scene Change

From main window->Setup->Event->Video detect->Scene change, the video diagnosis interface is shown as in Figure 4-61.

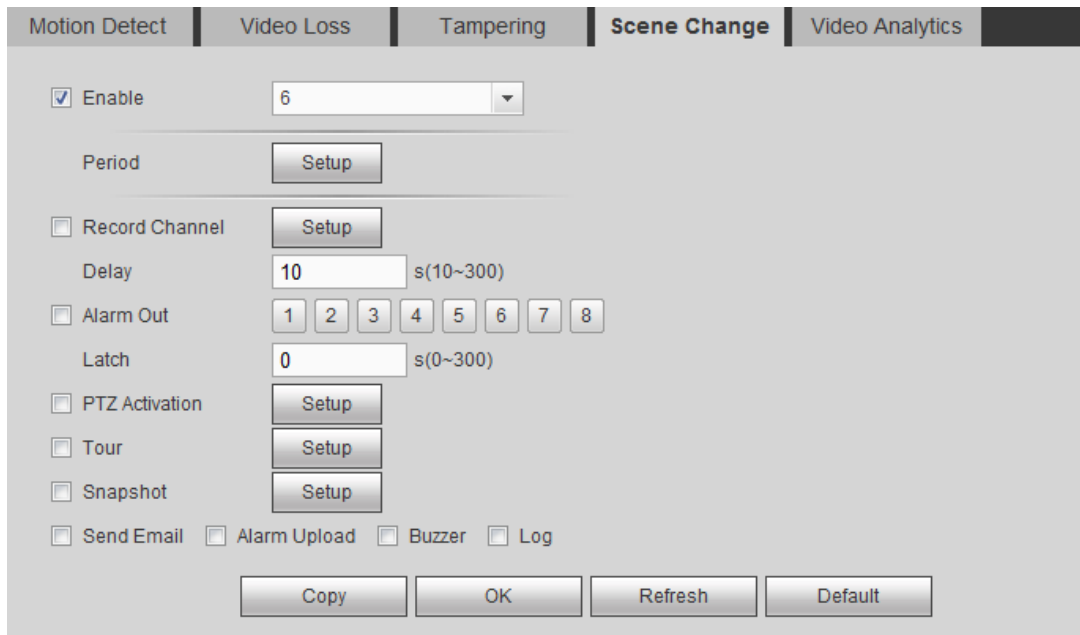

Figure 4-61

For detailed setups, please refer to chapter 4.8.3.1.1 motion detect for detailed information.

#### 4.8.3.1.5 Video analytics

From main window->Setup->Event->Video detect->Video diagnosis, the video diagnosis interface is shown as in Figure 4-62.

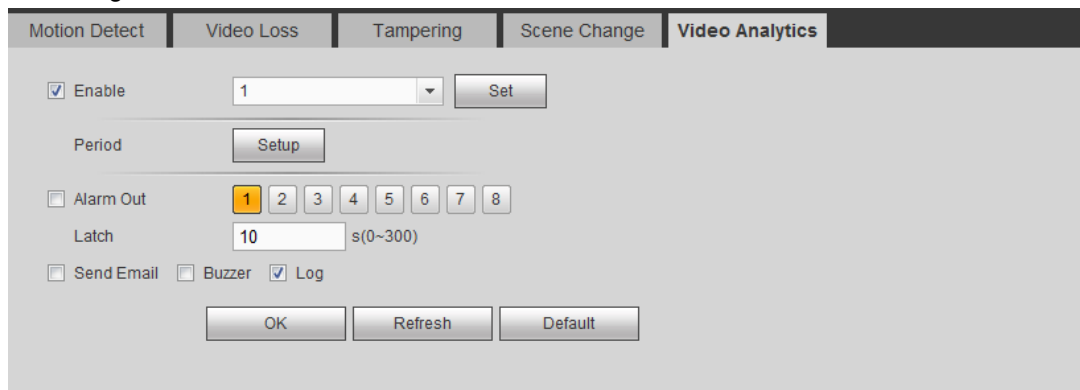

Figure 4-62

Click Set button, the interface is shown as below. See Figure 4-63.

System can generate an alarm once there is stripe, noise, or video is color cast, out of focus or over exposure.

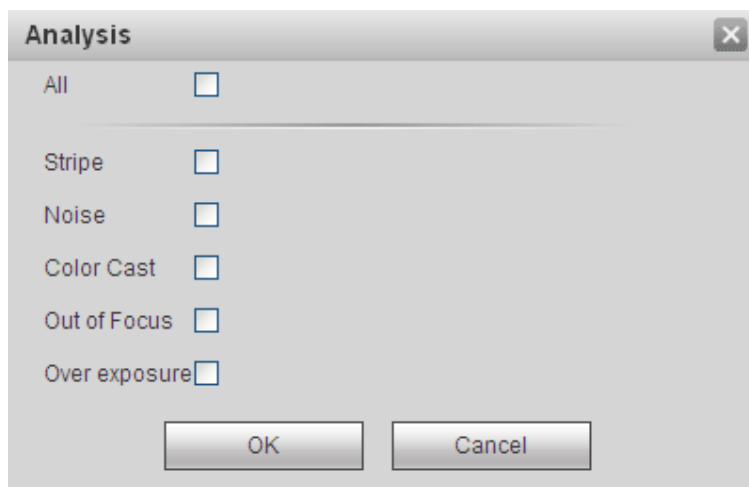

Figure 4-63

For detailed setups, please refer to chapter 4.8.3.1.1 motion detect for detailed information.

#### 4.8.3.2 IVS Plan

From main menu->Setup->Event->IVS plan, user may go to the IVS plan interface. See Figure 4-64.

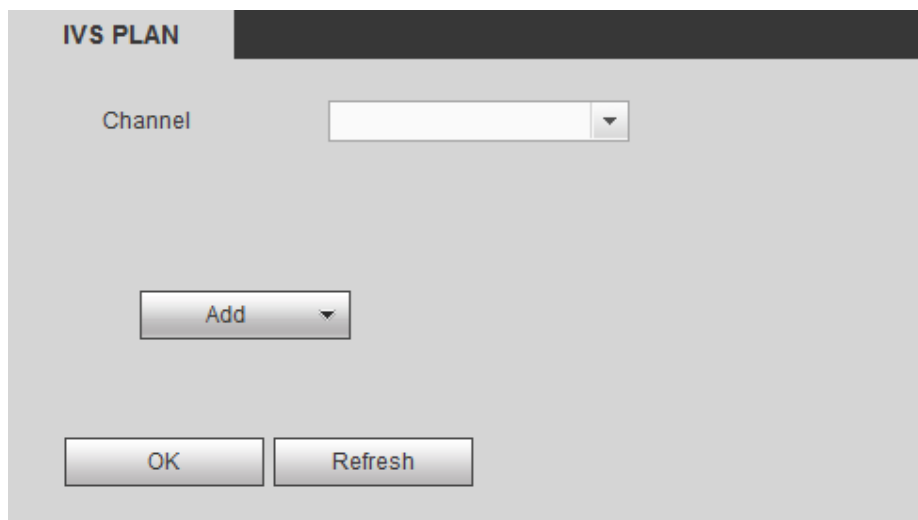

Figure 4-64

Select a channel from the dropdown list. Click Add button, user may see an interface shown as below. See Figure 4-65.

Select a channel from the dropdown list and then set preset. Click Add button and then set the corresponding rule.

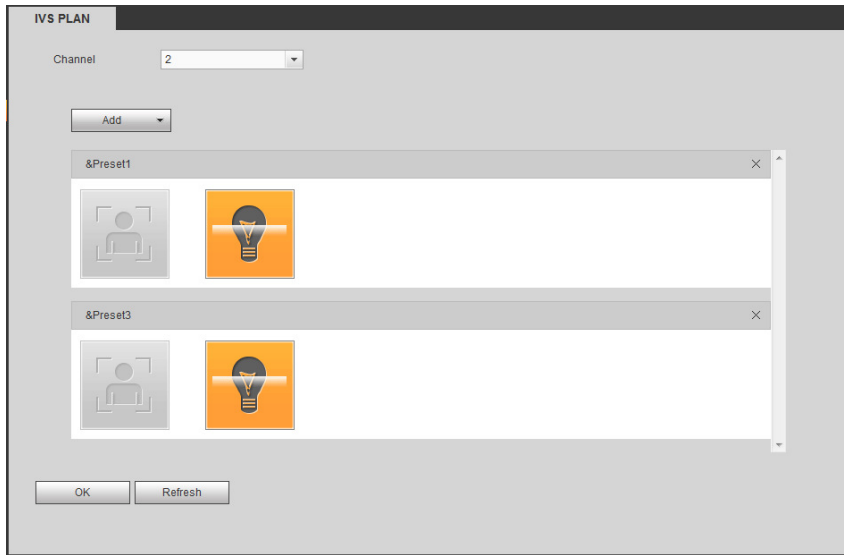

Figure 4-65

Click OK button to complete the setup.

#### 4.8.3.3 Behavior Analytics (Optional)

##### Important

- Please contact your retailer or you service engineer if user may not use the behavior analytics function.
- Right now, the behavior analytics supports 32 rules.

##### 4.8.3.3.1 Behavior Analytics

From main menu->Setup->Event->Behavior analytics->Behavior analytics, user may go to the Behavior analytics interface. See Figure 4-66.

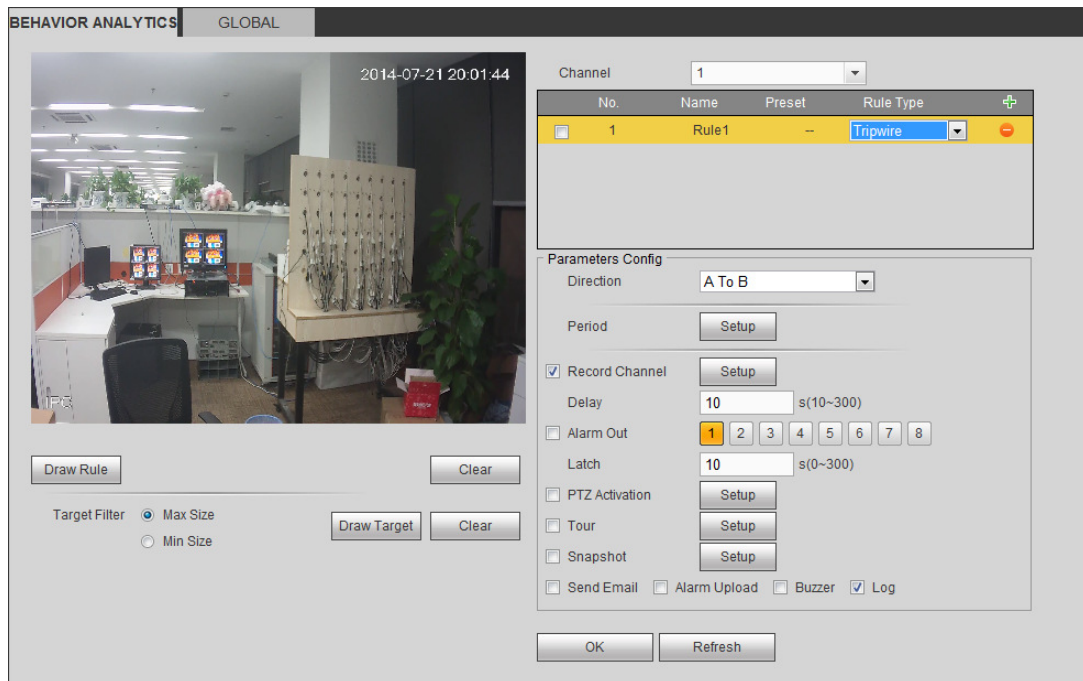



Figure 4-66

Please select a channel from the dropdown list

Click  to add a rule. The default setup is tripwire, user may double click the rule type name to modify.  
See Figure 4-67.

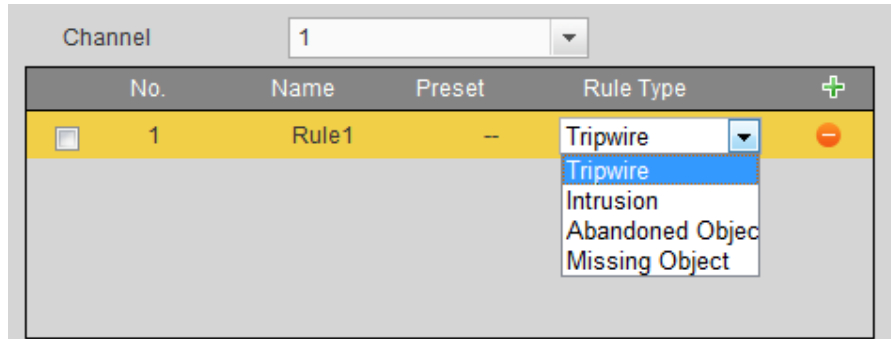



Figure 4-67

Then user may set corresponding parameters.  
Click OK button to complete the setup.

#### 4.8.3.3.1.1 Tripwire

From main menu->Setup->Event-> Behavior analytics->Behavior analytics, click  user may see the following interface. See Figure 4-68.

System generates an alarm once there is any object crossing the tripwire in the specified direction.

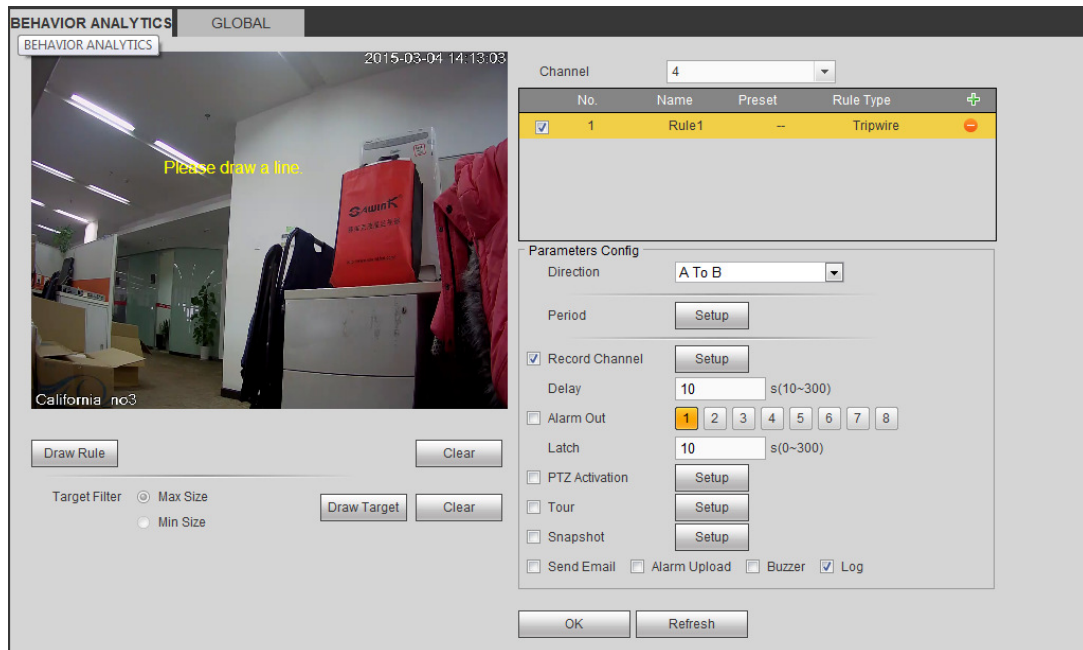

Figure 4-68

Check the Tripwire box to enable tripwire function.

Select SN (Line1/2/3/4) and direction, and then input customized rule name.

- Direction: There are three options: A->B, B->A, both. System can generate an alarm once there is any object crossing in the specified direction.

Now user may draw a rule. Click Draw rule button and then left click mouse to draw a tripwire. The tripwire can be a direct line, curve or polygon. Right click mouse to complete. See Figure 4-69.

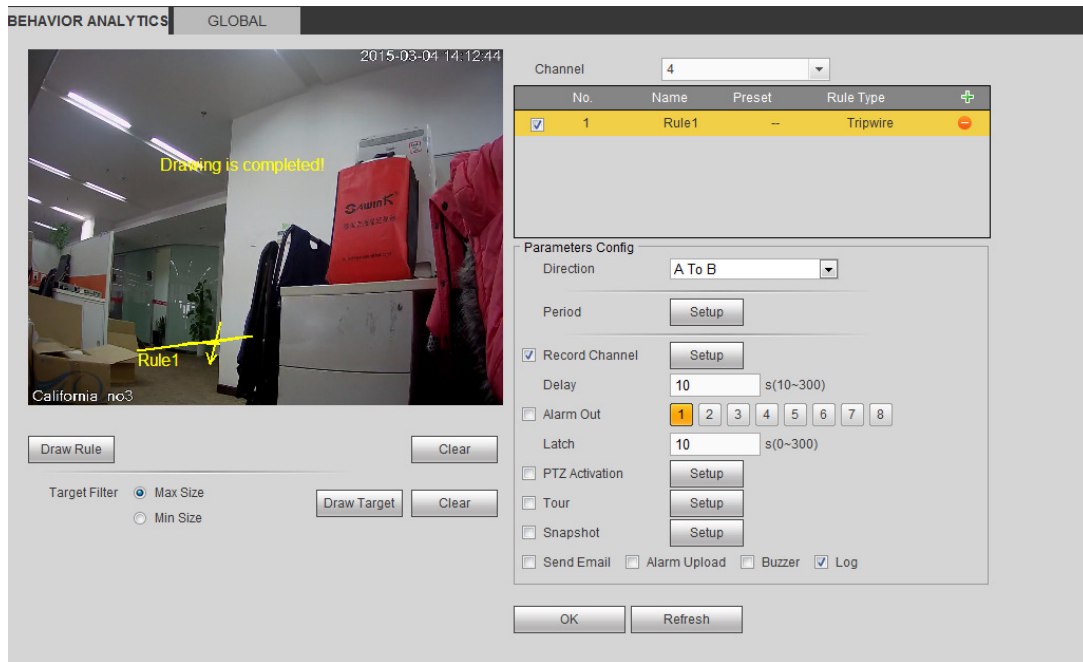

Figure 4-69

Click **Draw Target** to draw filter object. See Figure 4-70.

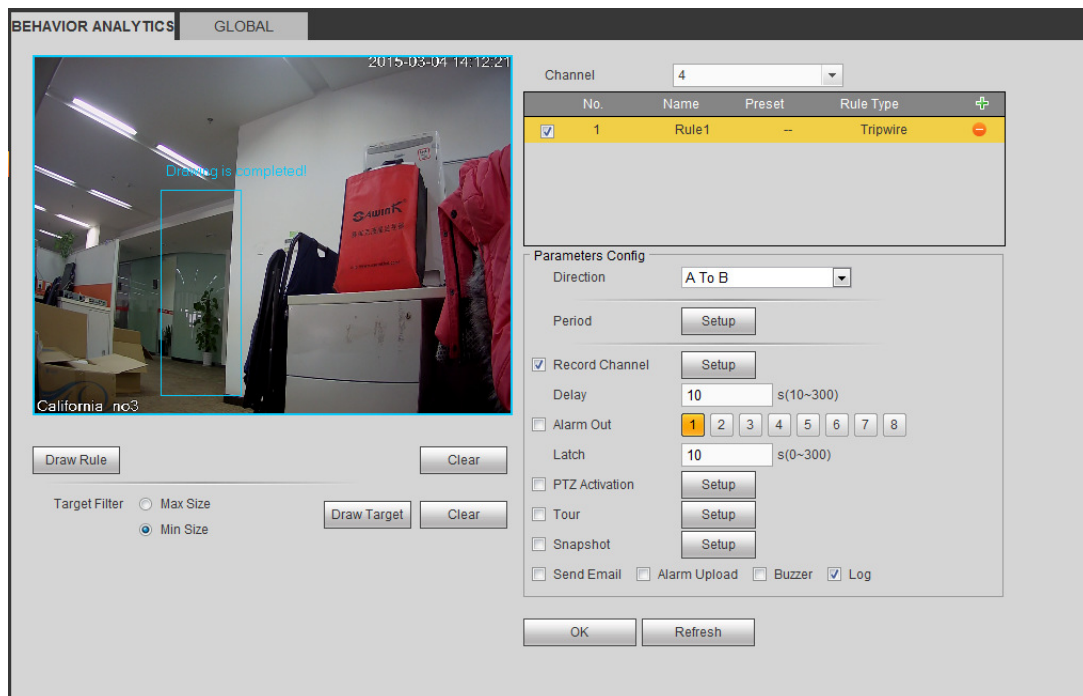

Figure 4-70

Select the blue line and then use mouse to adjust zone size.

**Note**

Each rule can set two sizes (min size/max size). Once the object is smaller than the min size or larger



than the max size, there is no alarm. Please make sure the max size is larger than the min size.  
 Click Ok to complete the rule setup.  
 For detailed setups, please refer to chapter 4.8.3.1.1 motion detect for detailed information.

#### 4.8.3.3.1.2 Intrusion (Cross warning zone)

From main menu->Setup->Event-> Behavior analytics->Behavior analytics, click , and then select rule type as intrusion, user may see the following interface. See Figure 3-116.

**Note:**

- System supports customized area shape and amount.
- Support enter/leave/both detection.
- Can detect the moving object operation in the specified zone, customized trigger amount and staying time.
- Support objects filter function.

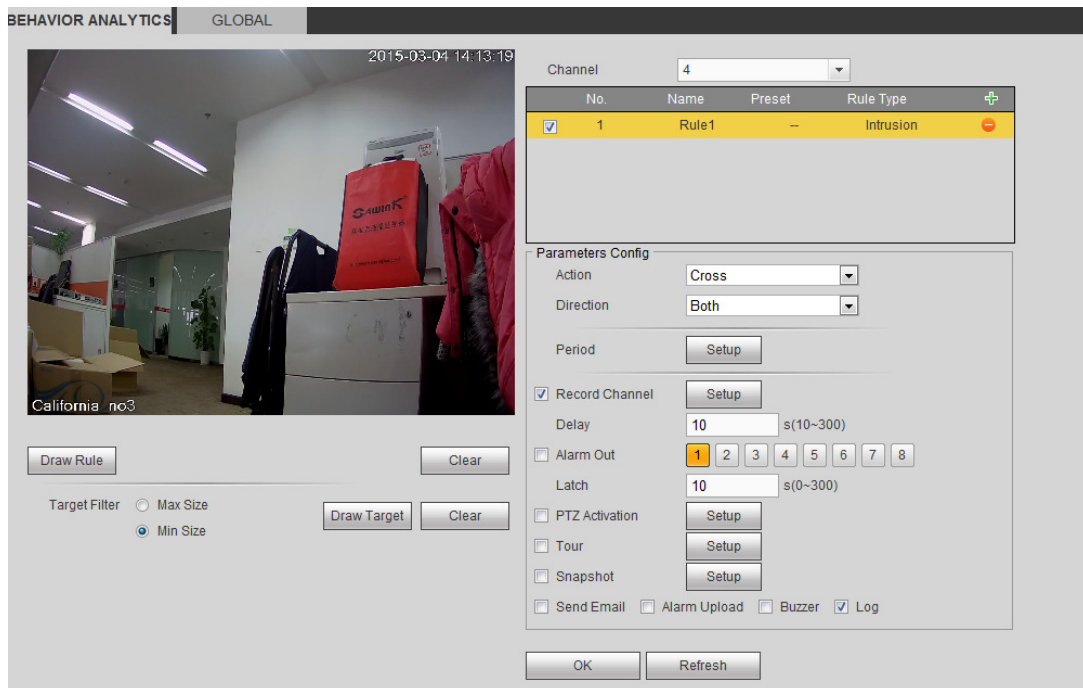

Figure 4-71

Check the Intrusion box to enable intrusion function.

Select SN (Area1/2/3/4) and direction, and then input customized rule name.

- Action: System supports two types: appear/cross.
- Direction: There are three options: A->B, B->A, both. System can generate an alarm once there is any object enter/exit (Or both) the zone.

Now user may draw a rule. Left click mouse to draw a line first and then right click mouse to draw another line until you draw a rectangle, user may right click mouse to exit.

Click Ok to complete the rule setup.

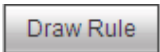
Click  to draw the zone. See Figure 4-72.

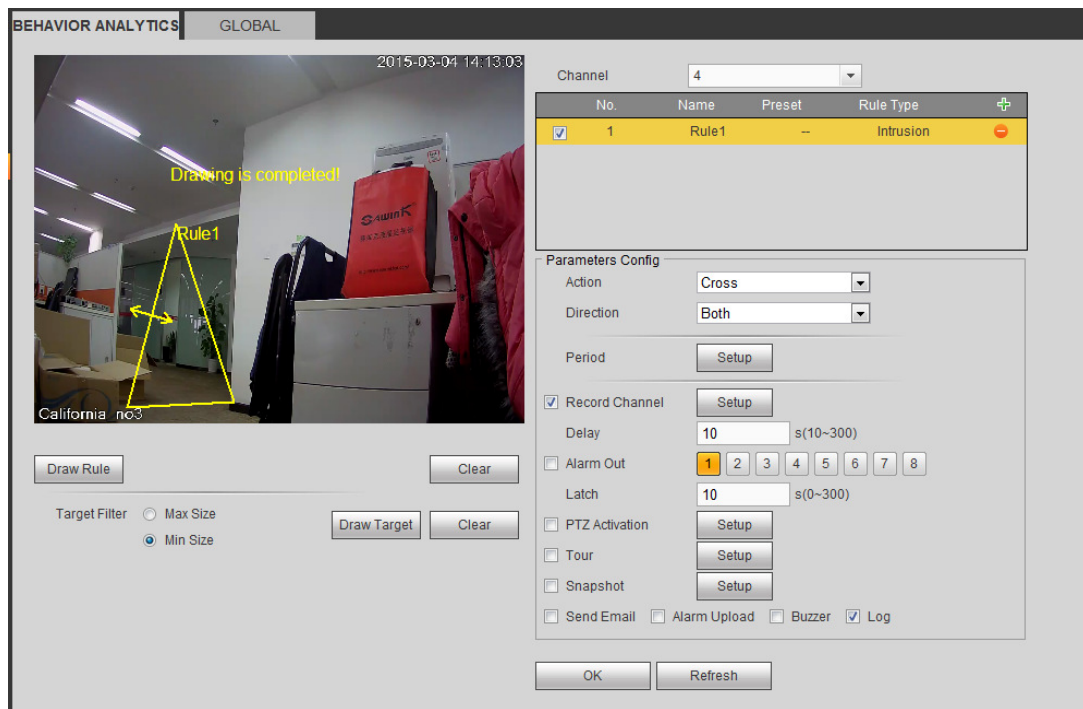



Figure 4-72

For detailed setups, please refer to chapter 4.8.3.1.1 motion detect for detailed information.

#### 4.8.3.3.1.3 Abandoned Object Detect

From main menu->Setup->Event-> Behavior analytics->Behavior analytics, click , and then select rule type as abandoned object detection, user may see the following interface. See Figure 4-73.

- System supports customized area shape and amount.
- Support duration setup.
- Support objects filter function.

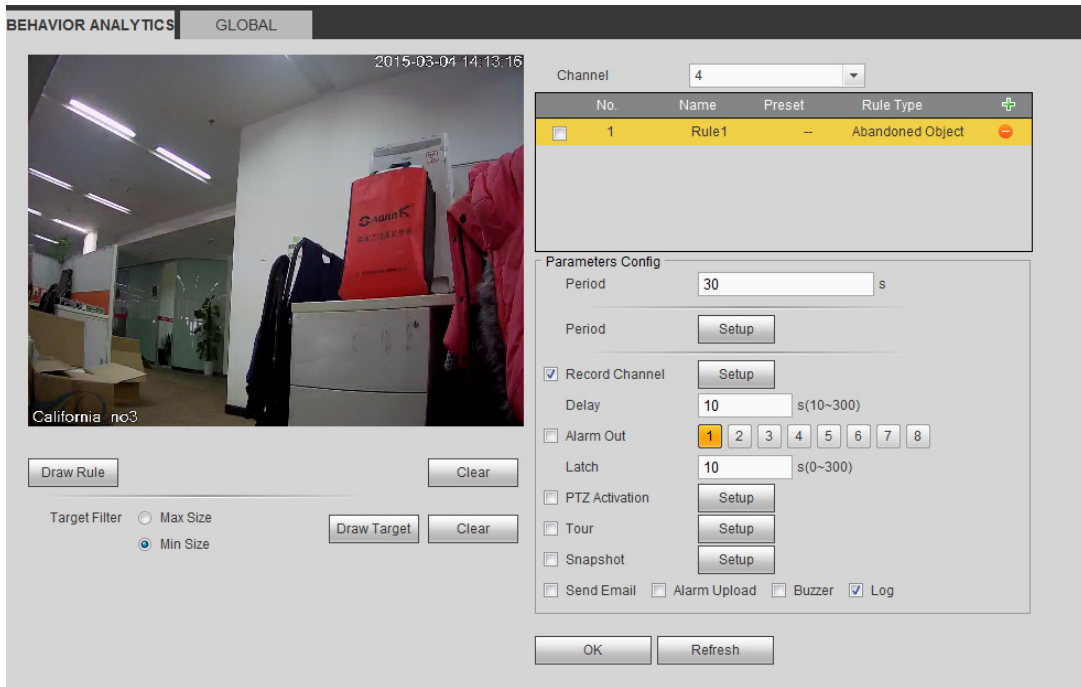

Figure 4-73

Check the Object box to enable object detect function.

- Period: System can generate an alarm once the object is in the zone for the specified period.

Click **Draw Rule** to draw the rule. See Figure 4-74.

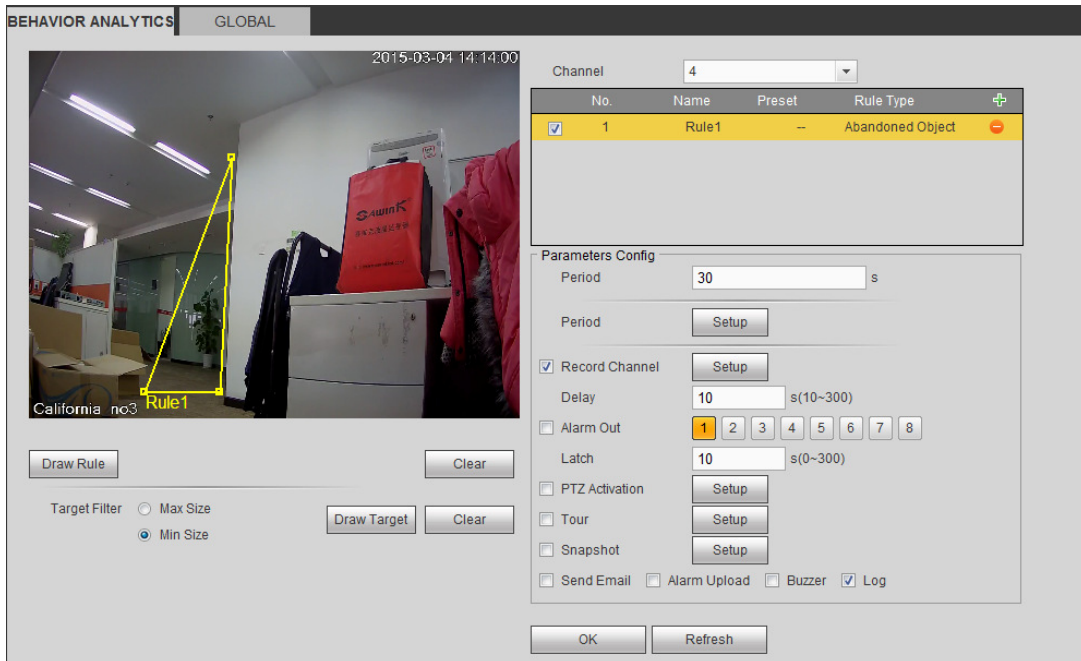



Figure 4-74

Now user may draw a rule. Left click mouse to draw a line, until you draw a rectangle, user may right click mouse.

Click Ok to complete the rule setup.

For detailed setups, please refer to chapter 4.8.3.1.1 motion detect for detailed information.

#### 4.8.3.3.1.4 Missing Object Detect

From main menu->Setup->Event-> Behavior analytics->Behavior analytics, click , and then select rule type as missing object detection, user may see the following interface. See Figure 4-75.

- System supports customized area shape and amount.
- Support period setup.
- Support objects filter function.

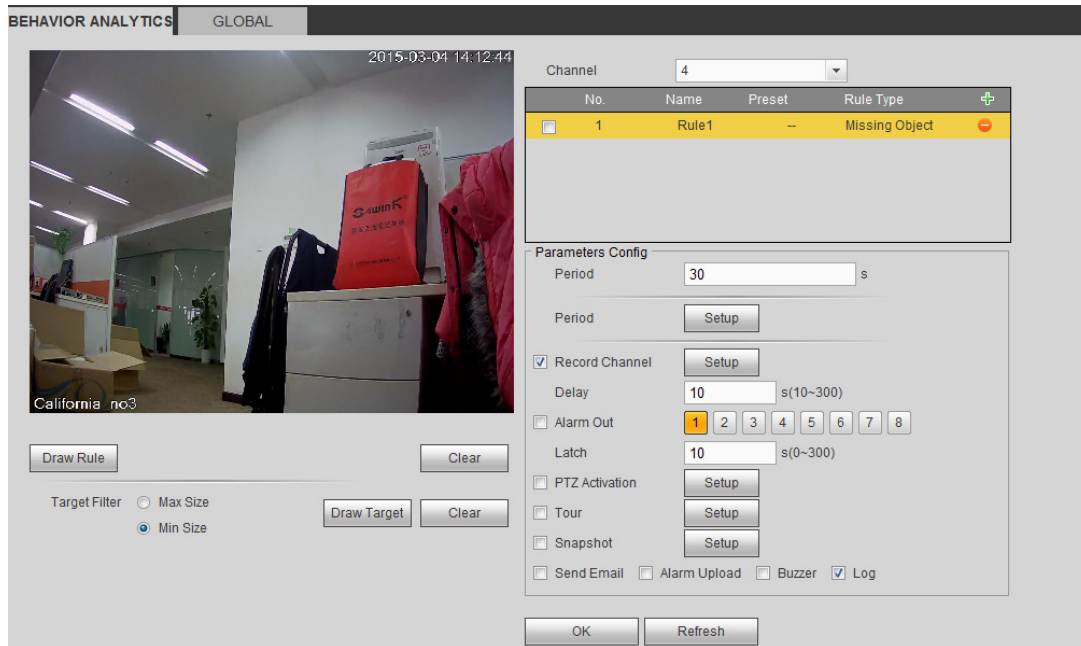
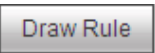

Figure 4-75

Click  to draw the rule. See Figure 4-76.

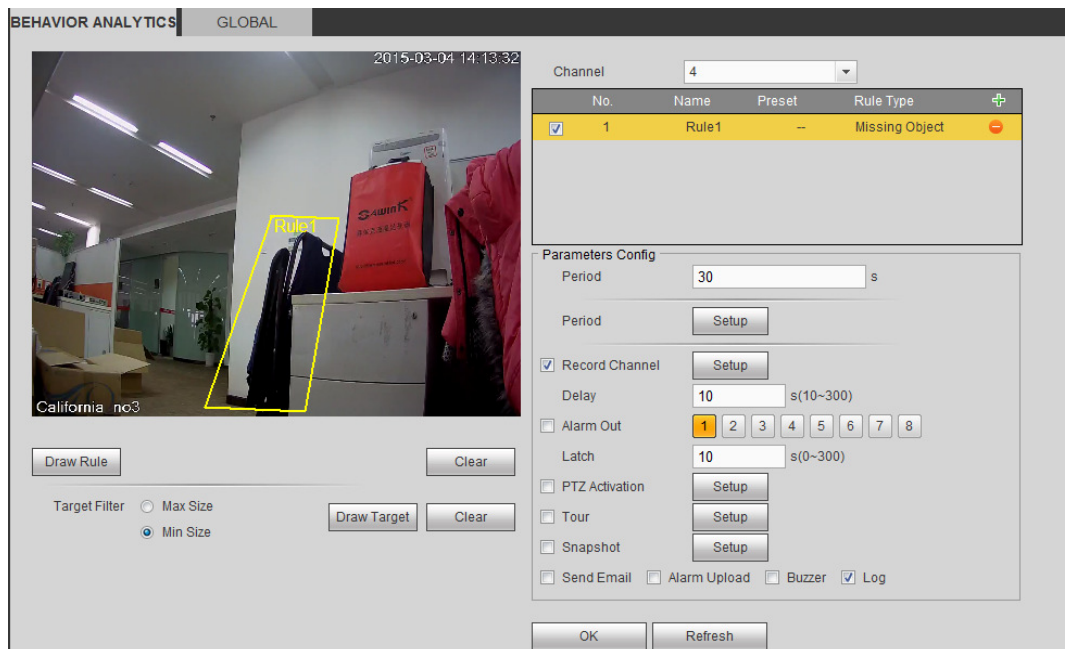



Figure 4-76

Click Ok to complete the rule setup.

For detailed setups, please refer to chapter 4.8.3.1.1 motion detect for detailed information.

#### 4.8.3.3.1.5 Loitering

From main menu->Setup->Event-> Behavior analytics->Behavior analytics, click , and then select rule type as loitering detection, user may see the following interface. See Figure 4-77.

#### Note

- System supports customized area shape and amount.
- Support duration setup.
- Support objects filter function.

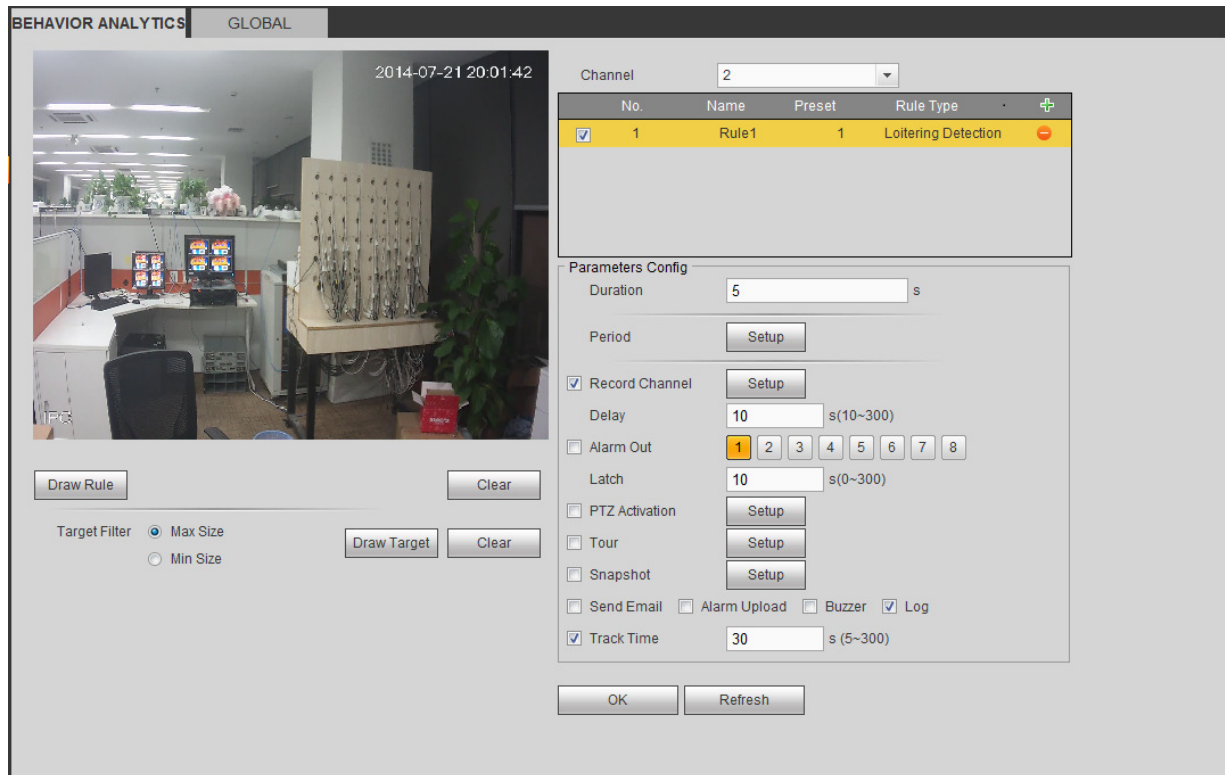

Figure 4-77

- Duration: System can generate an alarm once the object is in the zone for the specified period.

Click  to draw the rule.

Click OK to complete the rule setup.

For detailed setups, please refer to chapter 4.8.3.1.1 motion detect for detailed information.

#### 4.8.3.3.1.6 Crowd gathering detection

From main menu->Setup->Event-> Behavior analytics->Behavior analytics, click , and then select rule type as crowd gathering estimation, user may see the following interface. See Figure 4-78.

- Customized zone and amount setup.
- Duration setup.
- Sensitivity setup.
- Min gathering zone setup.

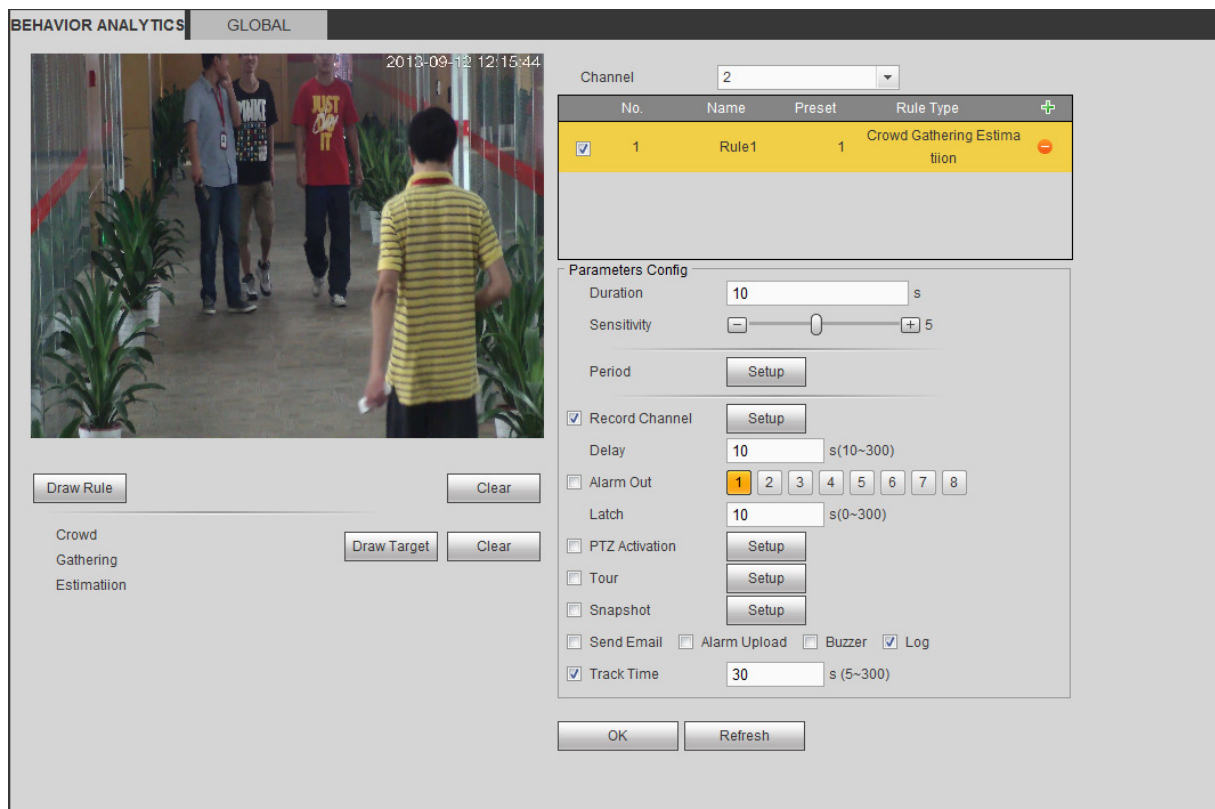

Figure 4-78

- Duration: System can generate an alarm once the object is in the zone for the specified period.
- Sensitivity: It is to set alarm sensitivity. The value ranges from 1 to 10. The default setup is 5.

Click **Draw Rule** to draw the rule.

Click OK to complete the rule setup.

For detailed setups, please refer to chapter 4.8.3.1.1 motion detect for detailed information.

#### 4.8.3.3.1.7 Fast moving

From main menu->Setup->Event-> Behavior analytics->Behavior analytics, click , and then select rule type as fast moving, user may see the following interface. See Figure 4-79.

- Sensitivity: It is to set alarm sensitivity. The value ranges from 1 to 10. The default setup is 5.

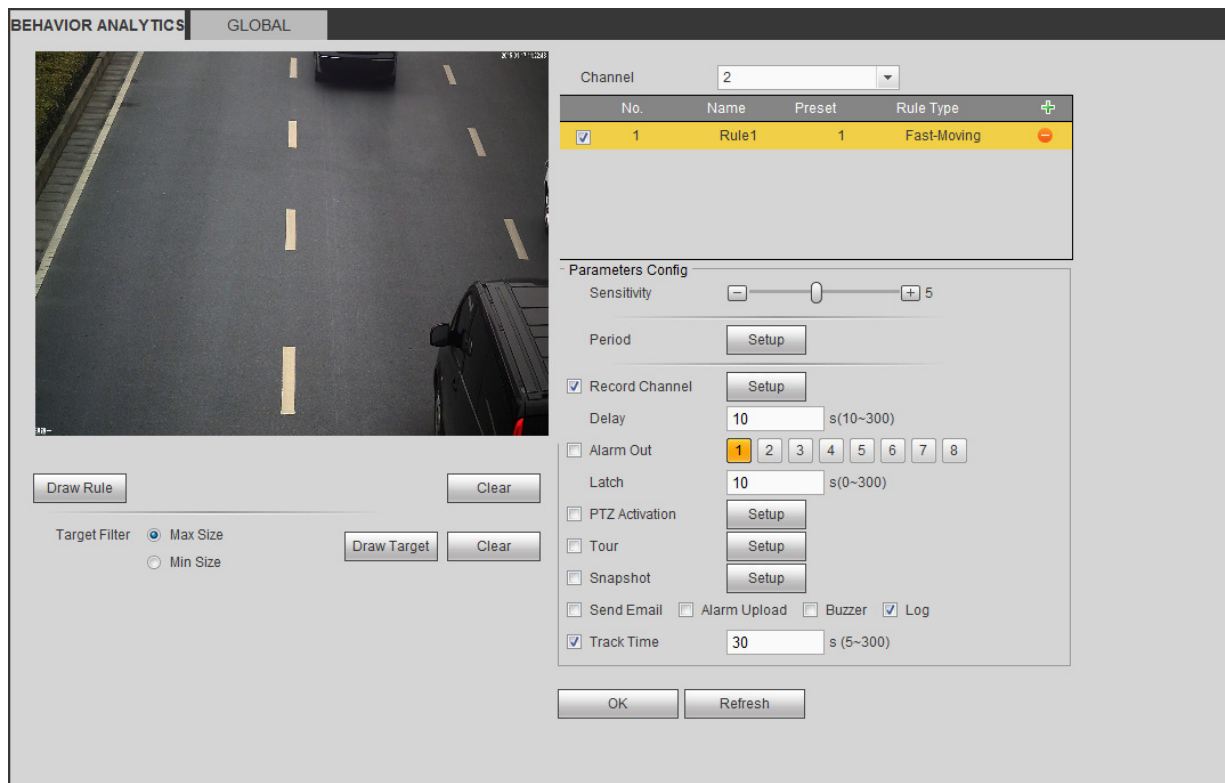

Figure 4-79

Click  to draw the rule.

Click OK to complete the rule setup.

For detailed setups, please refer to chapter 4.8.3.1.1 motion detect for detailed information.

#### 4.8.3.3.2 Global Config

From main menu->Setup->Event->Behavior analytics->Global, user may go to the global configuration interface. See Figure 4-80.

- Channel: Please select a channel from the dropdown list.
- Preset: Select a preset you want to set the rule. Please note, you need to add a preset first, otherwise, user may not see the preset dropdown list. If there is no preset, user may draw a rule in current channel.
- Calibration zone:
  - ✧ Click Add area , user may draw a calibration zone at the left pane of the interface. Select a zone and then click Delete zone button; user may remove the selected zone.
  - ✧ Select gauge type (vertical/level), user may set the corresponding length. User may draw three tilt gauges and one horizontal gauge at the left pane of the interface.
  - Select Width/Height and then click Verify, user may draw a line in the calibration zone, and then user may see its actual length.
  - Update preset: Click it to get the latest preset setup.

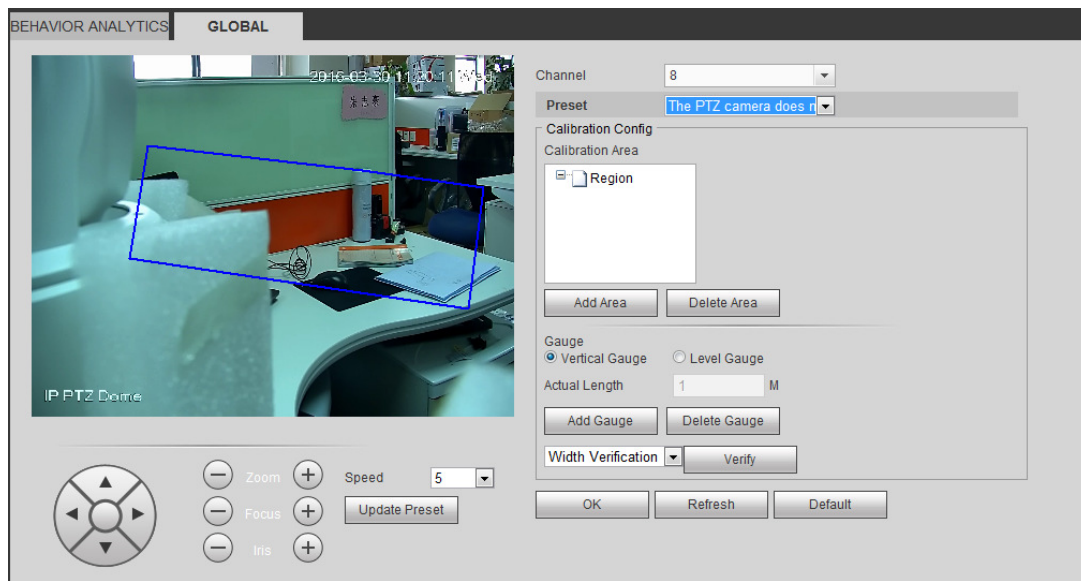

Figure 4-80

#### 4.8.3.4 Face Detect (Optional)

When camera detects human face, system can generate an alarm.

From main menu->Setup->Event->Face detect, the interface is shown as in Figure 4-81.

- Face ROI(Region of Interest): Check the box here, system can enhance the human face display pane.
- Sensitivity: System supports 6 levels. The sixth level has the highest sensitivity.

For detailed setups, please refer to chapter 4.8.3.1.1.

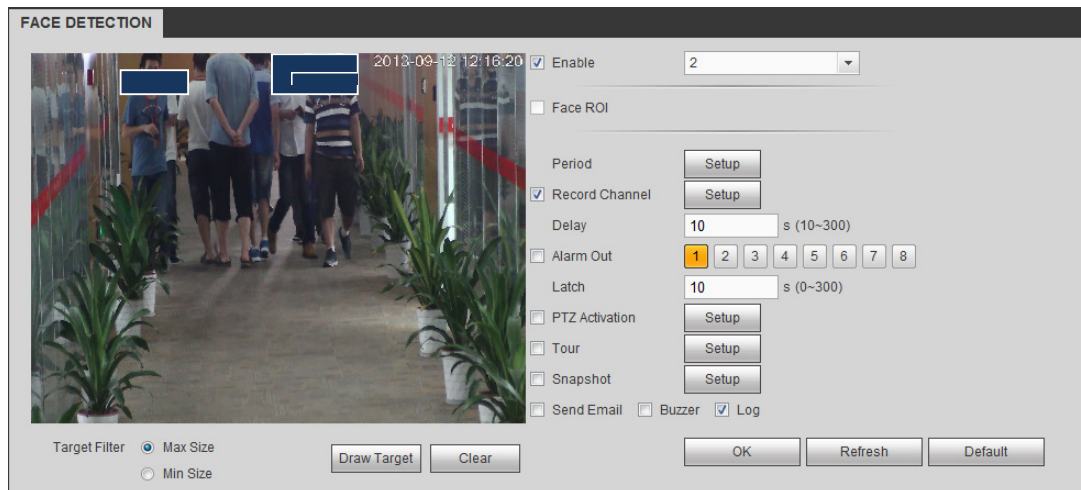

Figure 4-81

#### 4.8.3.5 People Counting

System can calculate the entry/exit people amount in the specified zone. It can generate an alarm when the amount has exceeded the threshold.

From main menu->Setup->Event->People counting, user may see an interface shown as in Figure 4-82.

- Channel: Please select a channel from the dropdown list. Check the box to enable people counting function.



- OSD overlay: Check the box here; user may view the people amount on the surveillance video.
- Direction: It is to set people flow direction. It includes entry/exit.
- Entry No.: It is to set people entry amount. System can generate an alarm once the amount has exceeded the threshold.
- Exit No.: It is to set people entry amount. System can generate an alarm once the amount has exceeded the threshold.
- Stranded No.: It is to set people staying amount in the zone. System can generate an alarm once the amount has exceeded the threshold.

For detailed setups, please refer to chapter 4.8.3.1.1 motion detect for detailed information.

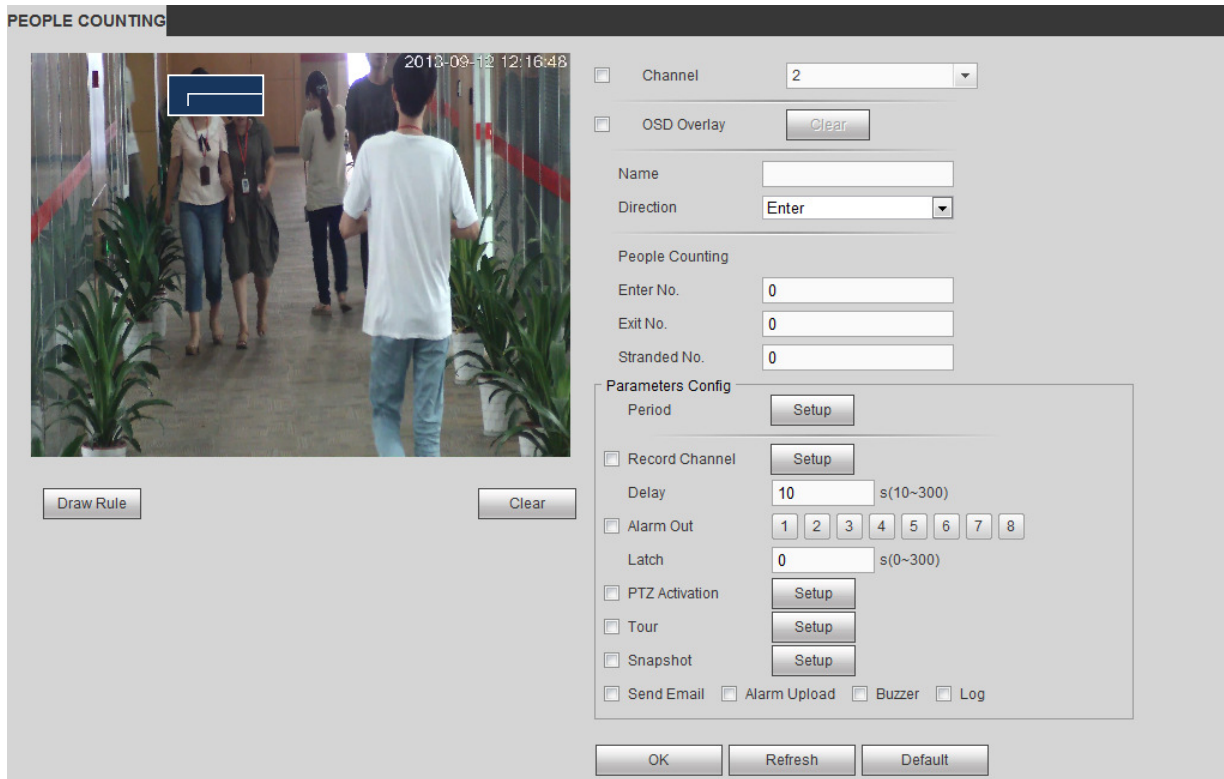

Figure 4-82

#### 4.8.3.6 Heat Map

It is to detect the object activity level in the scene during the specified period.

From main menu->Setup->Event->Heat Map, user may see an interface shown as in Figure 4-83.

For detailed setups, please refer to chapter 4.8.3.1.1 motion detect for detailed information.

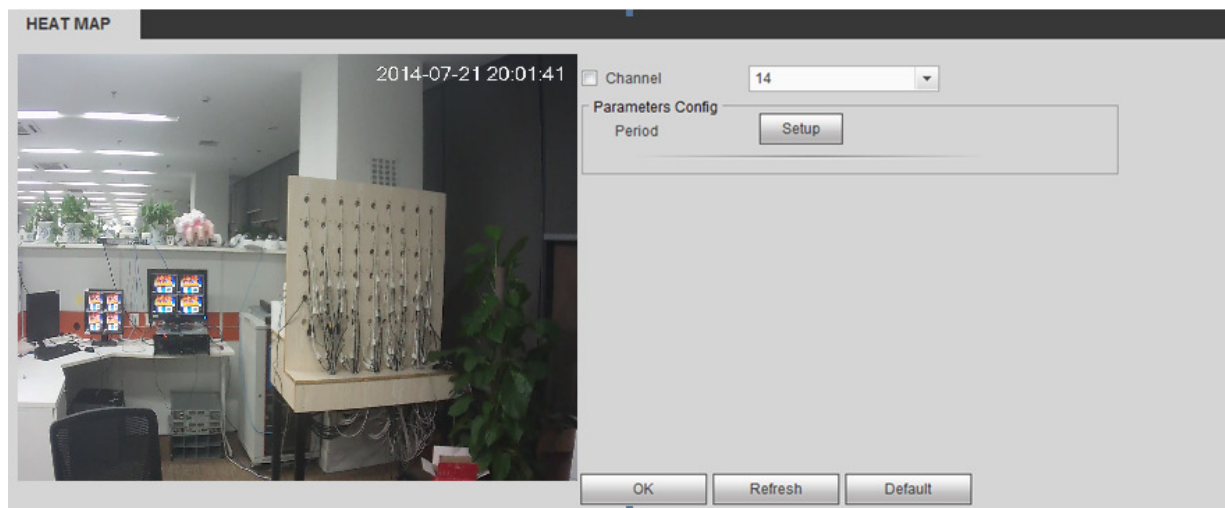

Figure 4-83

#### 4.8.3.7 Audio Detect

System can generate an alarm once it detect the audio input is abnormal or audio volume changes. From main menu->Setup->Event->Audio detect, user may see an interface shown as in Figure 4-84.

- Input abnormal: Check the box here, system can generate an alarm once the audio input is abnormal.
- Intensity change: Check the box here, system can generate an alarm once the audio volume becomes strong.
- Sensitivity: It refers to the audio recognition sensitivity. The higher the value is, the higher the sensitivity is.
- Threshold: It is to set intensity change threshold. The smaller the value is, the higher the sensitivity is.

For detailed setups, please refer to chapter 4.8.3.1.1 motion detect for detailed information.

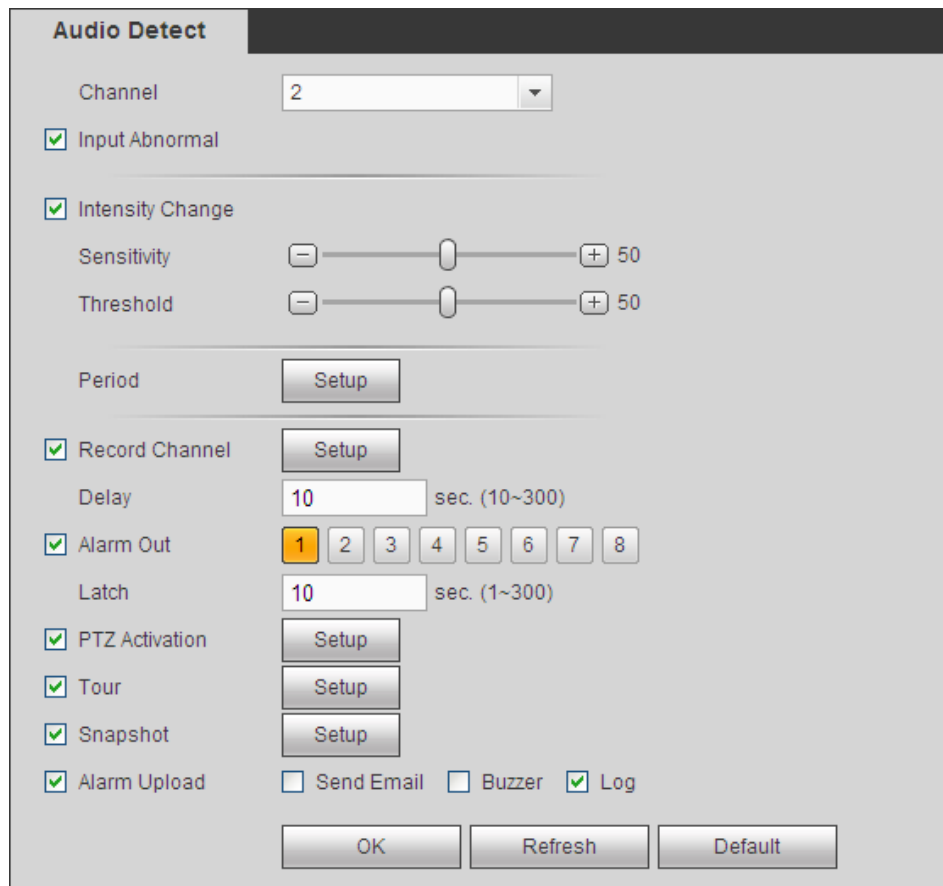

Figure 4-84

#### 4.8.3.8 Smart Track

From main menu->Setup->Event->Smart Track, the interface is shown as in Figure 4-85.

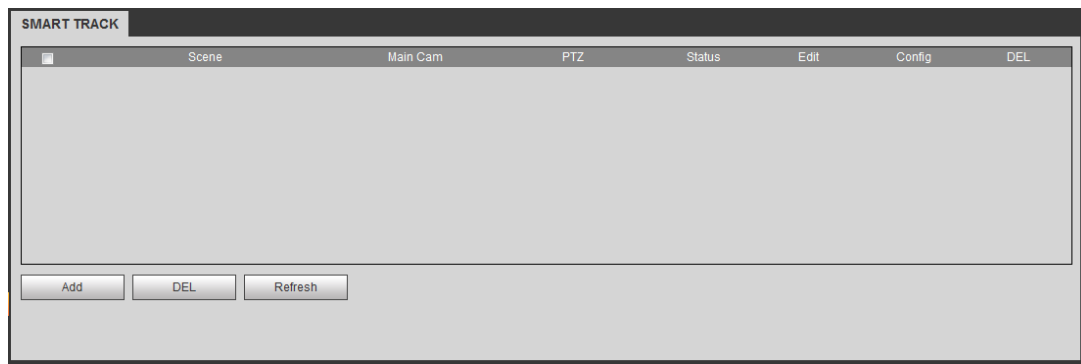

Figure 4-85

Click Add button, the interface is shown as below. See Figure 4-86.

- Type: Here user may select smart track mode. It includes: 1 fish eye+1 PTZ camera/1 fish eye+2 PTZ cameras/1 fish eye+3 PTZ cameras.
- Scene: It is the monitor position. Input customized monitor position name.
- Main channel: Click Select button and then select fish eye from the dialogue box.
- PTZ camera: Click Select button and then select corresponding PTZ camera amount from the

dialogue box.  
Click OK to complete the setup.

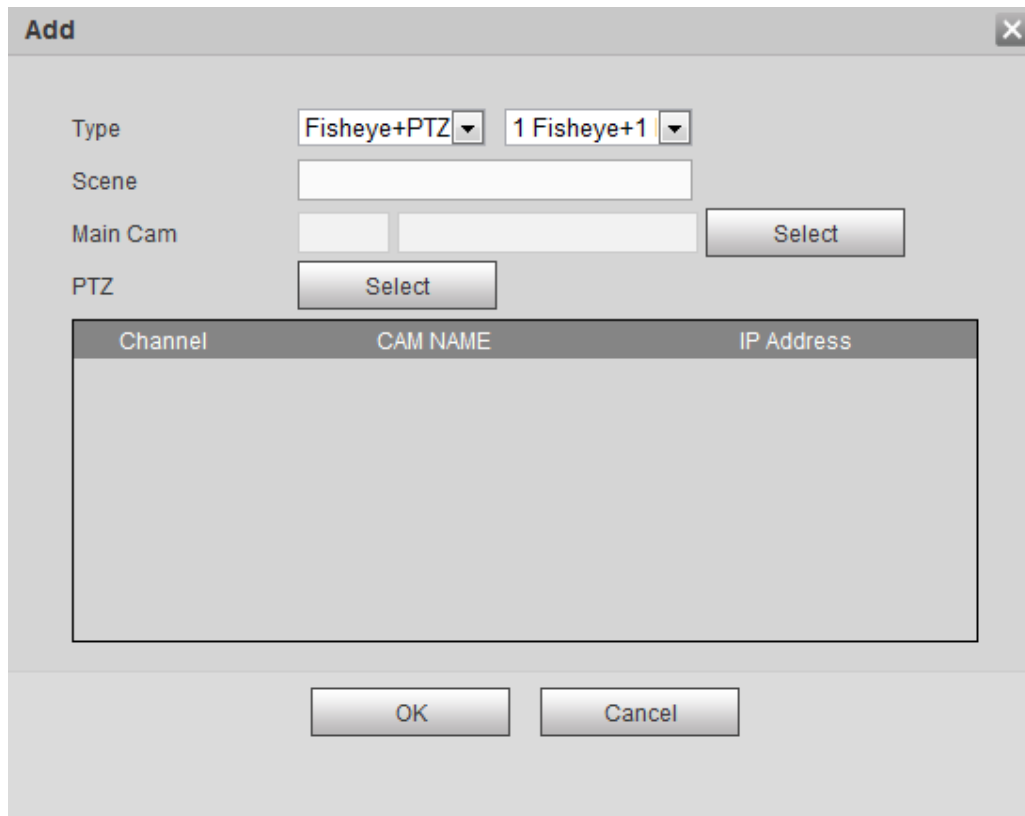

Figure 4-86

After you go back to the smart track interface, it is shown as in Figure 4-87.

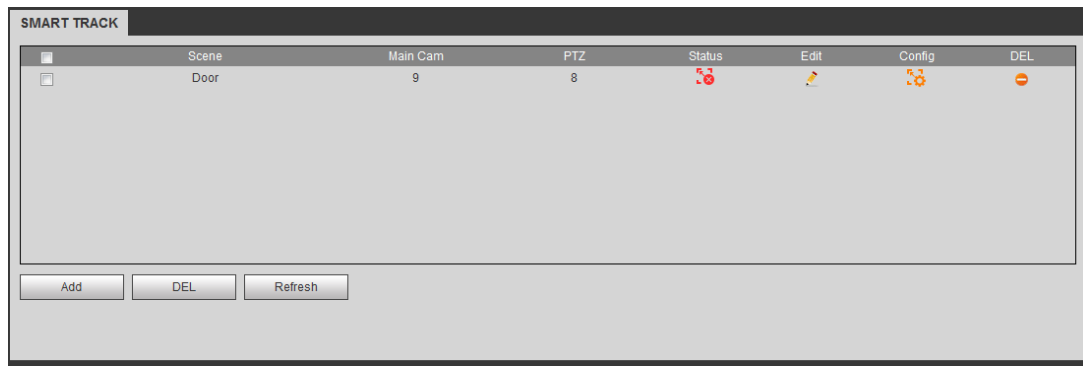



Figure 4-87

In Figure 4-87, click or double click the line, user may go to the following interface.  
See Figure 4-88. Here user may set the fish eye and PTZ camera bonding relationship.





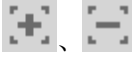



Figure 4-88

On the fish eye displayed zone, left click mouse or move  to confirm the position.

On the PTZ camera displayed zone, use the following buttons to adjust the PTZ camera position. It is to move the center position of the PTZ camera is the same as the  position of the fish eye.

**Note**

The  of the PTZ camera is the center position of the video.

Button	Function
	Zoom
	Focus
	Iris
	Electronic mouse, move it on the interface to control the PTZ direction.
	Fast position button. Click the button, and the select a position in the video. System auto uses the current clicked position as the center to adjust.

Button	Function
	<p>It is to control PTZ movement speed. The higher the value is, the faster the speed is.</p> <p>For example, the step 8 speed is faster than step 1.</p>

Click add button and then click  to save.

Now you complete one group position, user may view at the list. See Figure 4-89.



Main Cam	PTZ	Zoom	OPERATION	DEL
3942,816	1077,-20	128		

Figure 4-89

Repeat the above steps to set at least three group positions.

#### Note

- For one PTZ camera, there must be three calibration groups. System max supports 8 group positions. Please make sure the calibration position is accurate.
- For the first calibration group position, please select the reference objects at the far distance to enhance the trigger accuracy.

Click OK button to complete the calibration setup, user may go back to the smart track interface, the status is shown as .

#### 4.8.3.9 Alarm

Before operation, please make sure you have properly connected alarm devices such as buzzer. The input mode includes local alarm, network alarm, and IPC external alarm and IPC offline alarm.

##### 4.8.3.9.1 Local Alarm

From main menu->Setup->Event->Alarm->Local alarm, the local alarm interface is shown as in Figure 4-90. It refers to alarm from the local device.

**Local Alarm** | **Net Alarm** | **IPC External Alarm** | **IPC Offline Alarm**

Enable    1    Alarm Name

Period

Anti-dither 5 s(0-600)    Type NO

Record Channel         Easy Space

Delay 10 s(10-300)

Alarm Out    1 2

Latch 10 s (0-300)

PTZ Activation   

Tour   

Snapshot         Easy Space

Show Message     Send Email     Alarm Upload     Buzzer     Log

Figure 4-90

**Setup**

Thursday

<input checked="" type="checkbox"/>	00 : 00 -	24 : 00
<input type="checkbox"/>	00 : 00 -	24 : 00
<input type="checkbox"/>	00 : 00 -	24 : 00
<input type="checkbox"/>	00 : 00 -	24 : 00
<input type="checkbox"/>	00 : 00 -	24 : 00
<input type="checkbox"/>	00 : 00 -	24 : 00

Figure 4-91

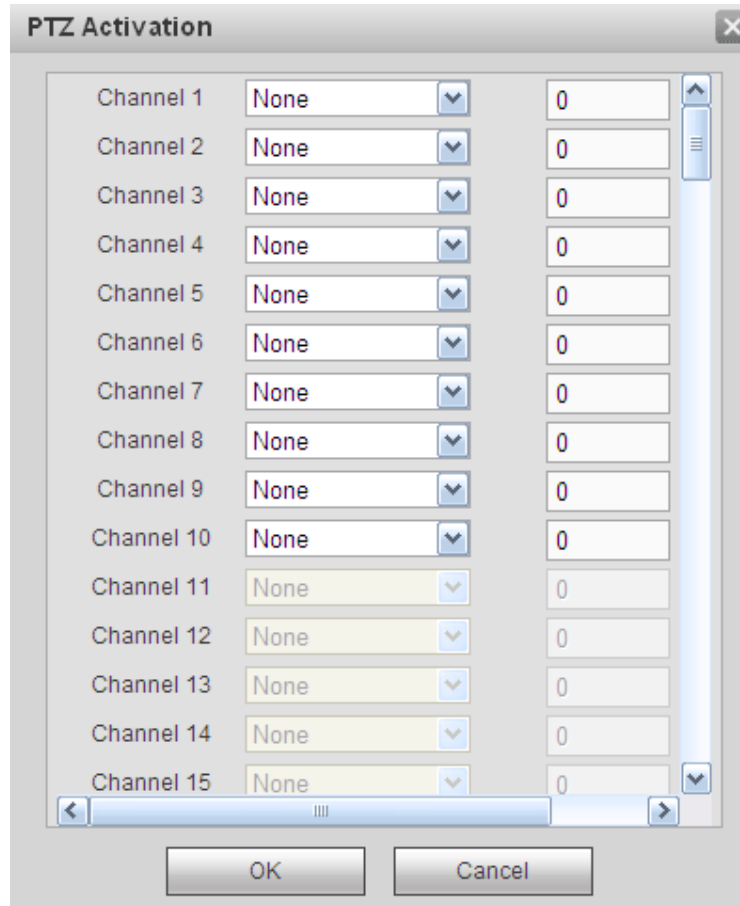

Figure 4-92

Please refer to the following sheet for detailed information.

Parameter	Function
Enable	You need to check the box to enable this function. Please select a channel from the dropdown list.
Period	This function becomes activated in the specified periods. There are six periods in one day. Please draw a circle to enable corresponding period. Select date. If you do not select, current setup applies to today only. User may select all week column to apply to the whole week. Click OK button, system goes back to local alarm interface, please click save button to exit.
Anti-dither	System only memorizes one event during the anti-dither period. The value ranges from 5s to 600s.
Sensor type	There are two options: NO/NC.
Record channel	System auto activates motion detection channel(s) to record once an alarm occurs. Please note you need to set alarm record period and go to Storage-> Schedule to set current channel as schedule record.



Parameter	Function
Record Delay	System can delay the record for specified time after alarm ended. The value ranges from 10s to 300s.
Alarm out	Enable alarm activation function. You need to select alarm output port so that system can activate corresponding alarm device when an alarm occurs.
Latch	System can delay the alarm output for specified time after an alarm ended. The value ranges from 1s to 300s.
Show message	System can pop up a message to alarm you in the local host screen if you enabled this function.
Buzzer	Check the box here to enable this function. The buzzer beeps when an alarm occurs.
Alarm upload	System can upload the alarm signal to the centre (Including alarm centre).
Send Email	If you enabled this function, System can send out an email to alert you when an alarm occurs.
Tour	You need to click setup button to select tour channel. System begins 1-window or multiple-window tour display among the channel(s) you set to record when an alarm occurs. See Figure 4-57.
PTZ Activation	Here user may set PTZ movement when an alarm occurs. Such as go to preset X. See Figure 4-92.
Snapshot	Click setup button to select snapshot channel. See Figure 4-58.

#### 4.8.3.9.2 Net Alarm

From main menu->Setup->Event->Alarm->Net alarm, the network alarm interface is shown as in Figure 4-93.

Network alarm refers to the alarm signal from the network. System does not anti-dither and sensor type setup. For setup information, please refer to chapter 4.8.3.9.1.

Local Alarm	Net Alarm	IPC External Alarm	IPC Offline Alarm
<input checked="" type="checkbox"/> Enable	1	Alarm Name	
Period	Setup		
<input checked="" type="checkbox"/> Record Channel	Setup	<input type="checkbox"/> Easy Space	
Delay	10	s(10-300)	
<input type="checkbox"/> Alarm Out	1 2		
Latch	10	s (0-300)	
<input type="checkbox"/> PTZ Activation	Setup		
<input type="checkbox"/> Tour	Setup		
<input type="checkbox"/> Snapshot	Setup	<input type="checkbox"/> Easy Space	
<input type="checkbox"/> Send Email	<input type="checkbox"/> Buzzer	<input checked="" type="checkbox"/> Log	
<div style="display: flex; justify-content: space-around;"> <span>Copy</span> <span>OK</span> <span>Refresh</span> <span>Default</span> </div>			

Figure 4-93

#### 4.8.3.9.3 IPC external alarm

From main menu->Setup->Event->Alarm->IPC external alarm, the IPC external alarm interface is shown as in Figure 4-94.

Network alarm refers to the alarm signal from the network. System does not support anti-dither and sensor type setup. For setup information, please refer to chapter 4.8.3.9.1.

Local Alarm	Net Alarm	IPC External Alarm	IPC Offline Alarm
<input checked="" type="checkbox"/> Channel	5	Alarm Name	
Period	Setup		
Anti-dither	5	s(0-600)	Type NO
<input checked="" type="checkbox"/> Record Channel	Setup	<input type="checkbox"/> Easy Space	
Delay	10	s(10-300)	
<input type="checkbox"/> Alarm Out	1 2		
Latch	10	s (0-300)	
<input type="checkbox"/> PTZ Activation	Setup		
<input type="checkbox"/> Tour	Setup		
<input checked="" type="checkbox"/> Snapshot	Setup	<input type="checkbox"/> Easy Space	
<input checked="" type="checkbox"/> Show Message	<input type="checkbox"/> Send Email	<input type="checkbox"/> Buzzer	<input checked="" type="checkbox"/> Log
<div style="display: flex; justify-content: space-around;"> <span>Copy</span> <span>OK</span> <span>Refresh</span> <span>Default</span> </div>			

Figure 4-94

#### 4.8.3.9.4 IPC Offline Alarm

From main menu->Setup->Event->Alarm->IPC offline alarm, the IPC offline alarm interface is shown as in Figure 4-95.

System can generate an alarm once the network camera is offline. For setup information, please refer to chapter 4.8.3.9.1.

The screenshot shows the 'IPC Offline Alarm' configuration window. At the top, there are four tabs: 'Local Alarm', 'Net Alarm', 'IPC External Alarm', and 'IPC Offline Alarm', with the last one being active. The interface includes the following settings:

- Channel: 1
- Record Channel: Setup button,  Easy Space
- Delay: 10 s (10-300)
- Alarm Out: 1 2
- Latch: 10 s (0-300)
- PTZ Activation: Setup button
- Tour: Setup button
- Snapshot: Setup button,  Easy Space
- Show Message:  Send Email,  Buzzer,  Log

At the bottom, there are four buttons: 'Copy', 'OK', 'Refresh', and 'Default'.

Figure 4-95

#### 4.8.3.10 Abnormality

From main menu->Setup->Event->Abnormality, user may go to the abnormality interface. It includes three types: HDD/Network/Power fault. See Figure 4-96 through Figure 4-98.

The screenshot shows the 'Abnormality' configuration window with the 'HDD' tab selected. The interface includes the following settings:

- Event Type: No HDD
- Enable
- Alarm Out: 1 2 3 4 5 6 7 8
- Latch: 10 sec.(1-300)
- Show Message:  Send Email,  Alarm Upload,  Buzzer,  Log

At the bottom, there are two buttons: 'OK' and 'Refresh'.

Figure 4-96

The screenshot shows the NETWORK configuration page. At the top, there are three tabs: HDD, NETWORK (selected), and PowerFault. Below the tabs, the 'Event Type' is set to 'Disconnect' in a dropdown menu. There are three checked checkboxes: 'Enable', 'Alarm Out', and 'Show Message'. The 'Alarm Out' section has a row of eight buttons numbered 1 to 8, with button 1 highlighted in orange. Below this is a 'Latch' field with the value '10' and the unit 'sec.(1-300)'. Under 'Show Message', there are three unchecked checkboxes: 'Send Email', 'Buzzer', and 'Log'. At the bottom, there are two buttons: 'OK' and 'Refresh'.

Figure 4-97

This screenshot is identical to Figure 4-97, showing the NETWORK configuration page with the same settings: Event Type set to Disconnect, Enable, Alarm Out, and Show Message checked, Alarm Out buttons 1-8 with button 1 highlighted, Latch set to 10 sec.(1-300), and Send Email, Buzzer, and Log unchecked.

Figure 4-98

Please refer to the following sheet for detailed information.

Parameter	Function
Event Type	<ul style="list-style-type: none"> <li>The HDD event type includes: No HDD, HDD error, no space. See Figure 4-96.</li> </ul> <p>User may set one or more items here.</p> <p>Less than: User may set the minimum percentage value here (For HDD not space only). The device can alarm when capacity is not sufficient. You need to draw a circle to enable this function.</p> <ul style="list-style-type: none"> <li>Network event type includes: Disconnect/IP conflict/MAC conflict. See Figure 4-97.</li> <li>Power fault. The interface is shown as in Figure 4-98. This function for power-redundancy series product. When this function is on, user may remove one power sourcing from the system, it does not affect the normal operation of the device, but system will generate an alarm to alert you.</li> </ul>
Enable	Check the box here to enable selected function.

Parameter	Function
Alarm Out	Please select corresponding alarm output channel when an alarm occurs. You need to check the box to enable this function.
Latch	The alarm output can delay for the specified time after an alarm stops. The value ranges from 1s to 300s.
Show message	System can pop up a message to alarm you in the local host screen if you enabled this function.
Alarm upload	System can upload the alarm signal to the centre (Including alarm centre).
Send Email	If you enabled this function, System can send out an email to alert you when an alarm occurs.
Buzzer	Check the box here to enable this function. The buzzer beeps when an alarm occurs.

#### 4.8.3.11 Alarm Output

From main menu-> Setup->Event->Alarm output, it is to set alarm output mode. See Figure 4-99.

Figure 4-99

## 4.8.4 Storage

### 4.8.4.1 Schedule

#### 4.8.4.1.1 Record

From main menu-> Setup->Storage->Schedule->Record, user may go to the record interface. In this interfaces, user may add or remove the schedule record setup. See Figure 4-100.

There are five record modes: Regular, motion detect, alarm and MD&alarm, and intelligence. There are six periods in one day.

User may view the current time period setup from the color bar.

- Green color stands for the general record/snapshot.
- Yellow color stands for the motion detect record/snapshot.
- Red color stands for the alarm record/snapshot.
- Blue color stands for MD&alarm record/snapshot.
- Orange color stands for intelligent record/snapshot.

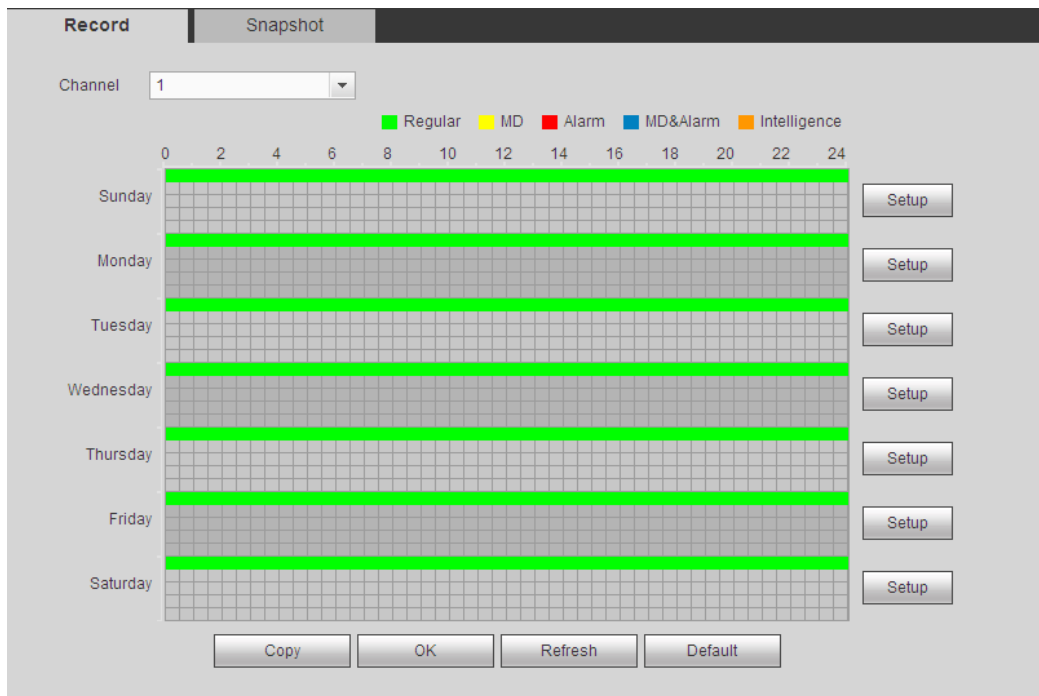

Figure 4-100

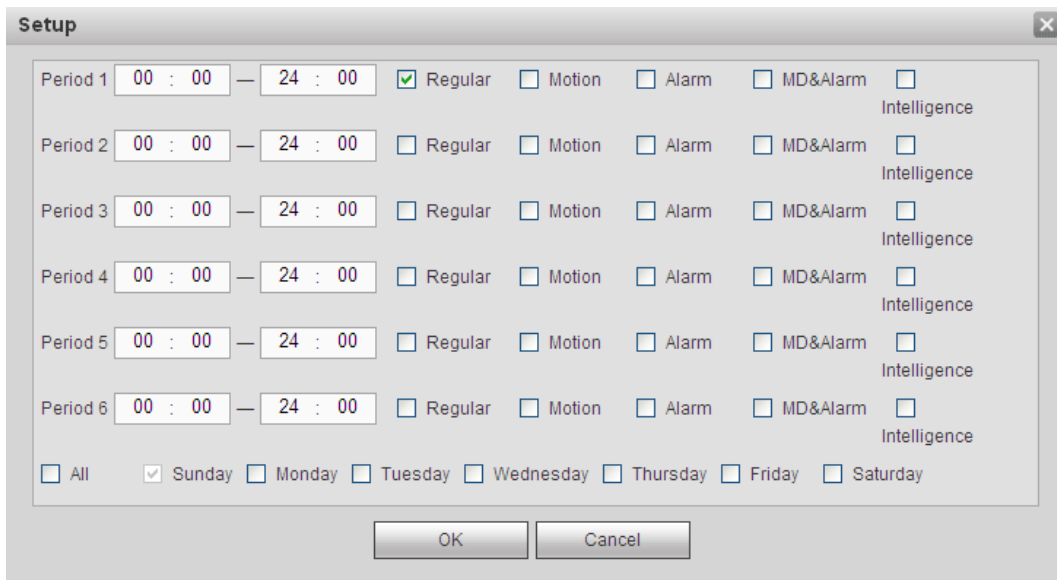

Figure 4-101

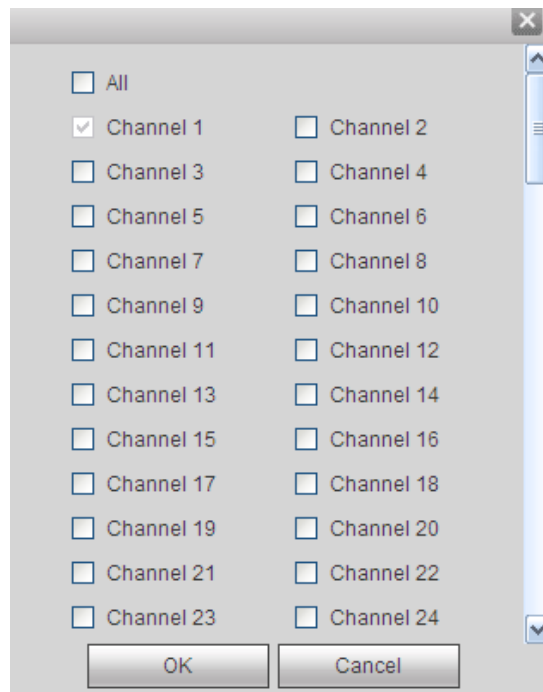

Figure 4-102

Please refer to the following sheet for detailed information.

Parameter	Function
Channel	Please select a channel from the dropdown list.
ANR	<p>Check the box here, user may enable ANR function. When the NVR and IPC connection is abnormal, the recorded file can be saved on the IPC (Please make sure your IPC has storage media and support this function). The NVR can download record from the IPC once the network connection is OK.</p> <p>User may set the max download record file length. Once the disconnection is more than the threshold you set here, NVR only downloads the specified record period.</p>
Pre-record	Please input pre-record time here. The value ranges from 0 to 30.
Redundancy	Check the box here to enable redundancy function. <b>Please note this function is null if there is only one HDD.</b>
Snapshot	Check the box here to enable snapshot function.
Holiday	Check the box here to enable holiday function.
Setup	<p>Click the Setup button, user may set record period. See Figure 4-101. There are six periods in one day. If you do not check the date at the bottom of the interface, current setup is for today only.</p> <p>Please click Save button and then exit.</p>
Copy	<p>Copy function allows you to copy one channel setup to another. After setting in channel, click Copy button, user may go to interface Figure 4-102. User may see current channel name is grey such as channel 1. Now user may select the channel you want to paste such as channel 5/6/7. If you want to save current setup of channel 1 to all channels, user may click the first box "ALL". Click the OK button to save current</p>

Parameter	Function
	copy setup. Click the OK button in the Encode interface, the copy function succeeded.

#### 4.8.4.1.2 Snapshot

From main menu-> Setup->Storage->Schedule->Snapshot, user may go to the record interface. Please refer to chapter 4.8.4.1.1 for detailed information.

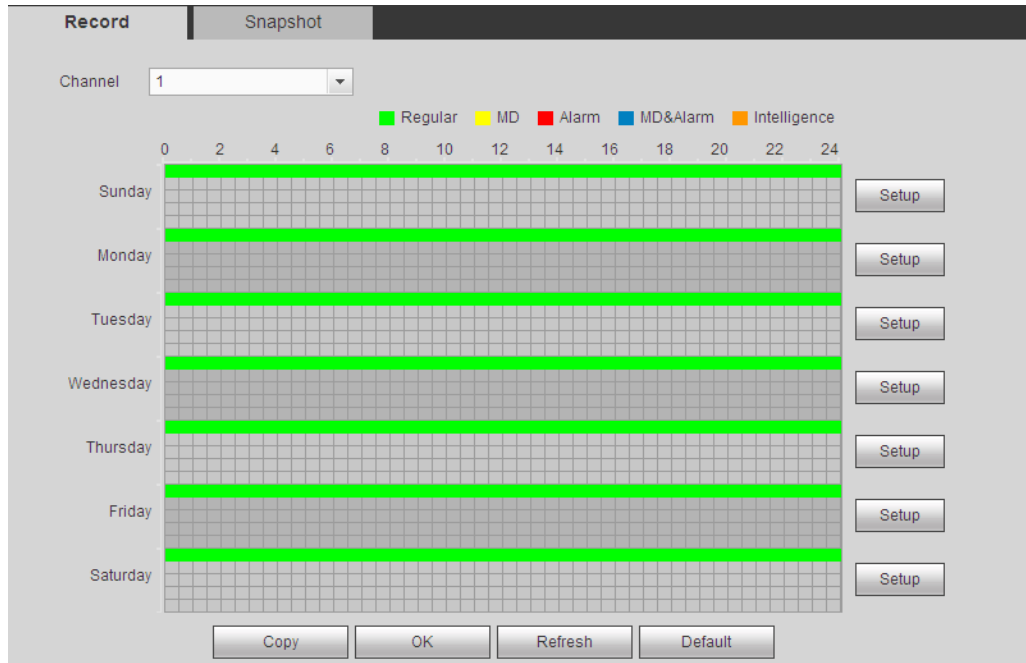

#### 4.8.4.2 HDD Manager

From main menu-> Setup->Storage->HDD manager, the HDD manager interface is shown as in Figure 4-103. Here user may see HDD information. User may also operate the read-only, read-write, redundancy (if there are more than one HDD) and format operation.

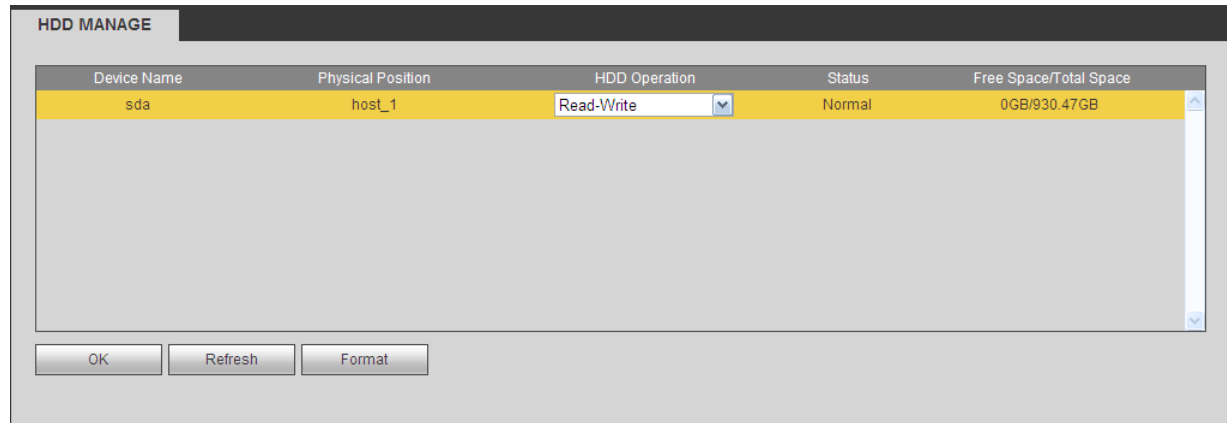

Figure 4-103

#### 4.8.4.3 Record Control

From main menu->Setup->Storage->Record, the interface is shown as in Figure 4-104.



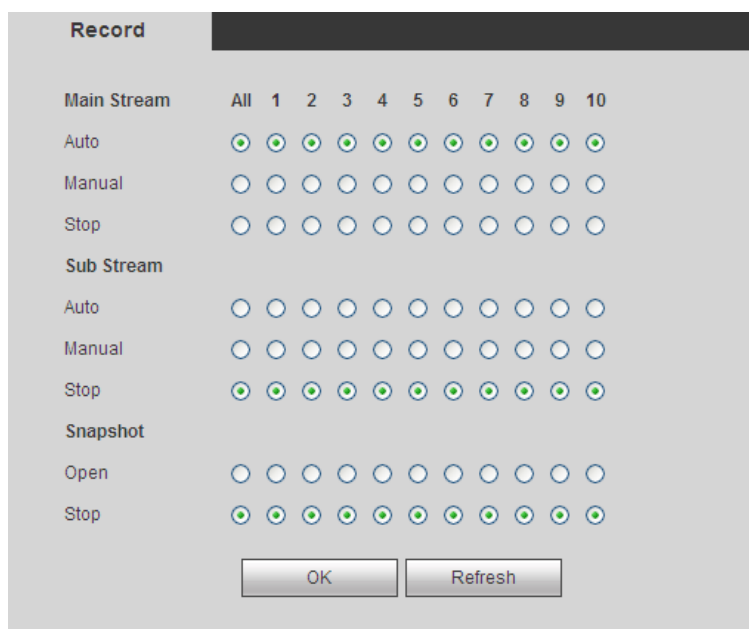

Figure 4-104

Please refer to the following sheet for detailed information.

Parameter	Function
Channel	Here user may view channel number. The number displayed here is the max channel amount of your device.
Status	There are three statuses: schedule, manual and stop.
Schedule	System enables auto record function as you set in record schedule setup (general, motion detect and alarm).
Manual	It has the highest priority. Enable corresponding channel to record no matter what period applied in the record setup.
Stop	Stop current channel record no matter what period applied in the record setup.
Start all/ stop all	Check the corresponding All button, user may enable or disable all channels record.

#### 4.8.4.4 Advanced

##### 4.8.4.4.1 HDD

From main menu->Setup->Storage->Advanced->HDD, the HDD interface is shown as below. See Figure 4-105. Here user may set HDD group.

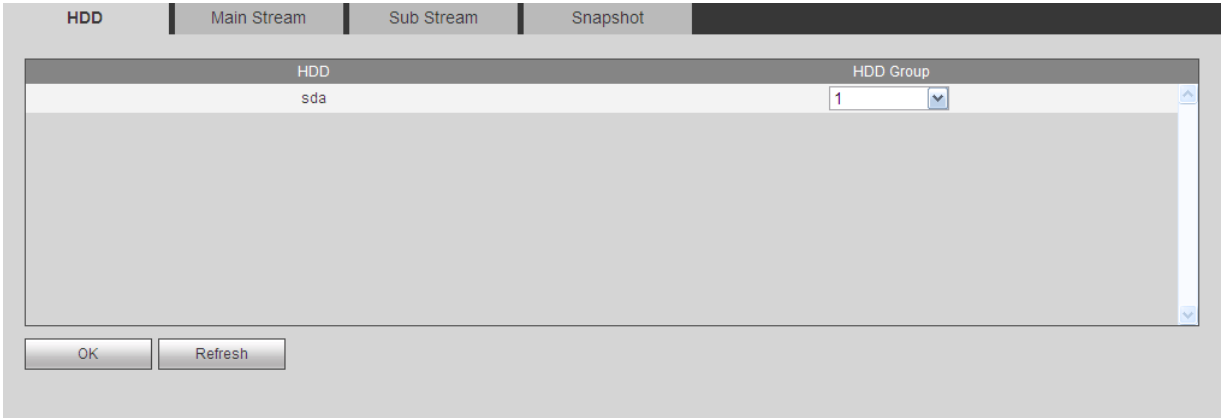

Figure 4-105

4.8.4.4.2 Main Stream

From main menu->Setup->Storage->Advanced->Main stream, the main stream interface is shown as in Figure 4-106. Here user may set corresponding HDD group to save main stream.

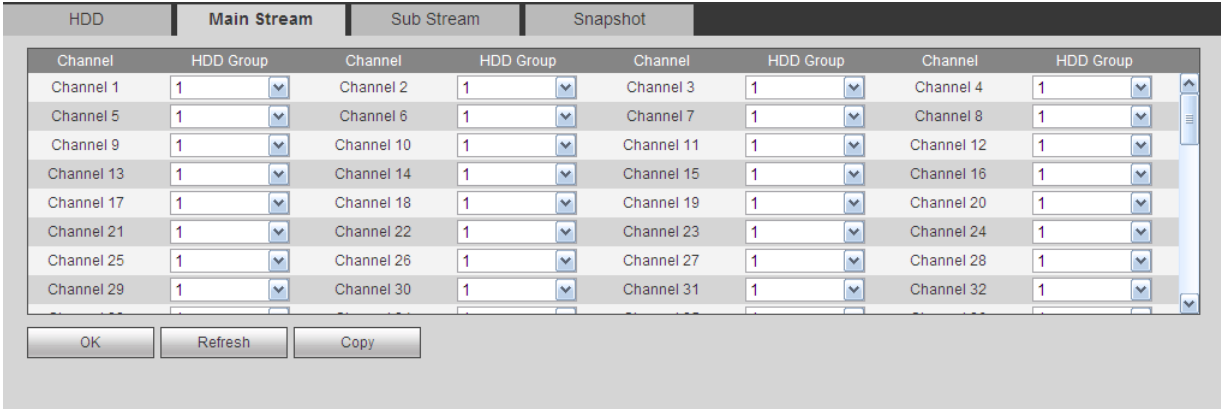

Figure 4-106

4.8.4.4.3 Sub Stream

From main menu->Setup->Storage->Advanced->Sub stream, the sub stream interface is shown as in Figure 4-107.

Here user may set corresponding HDD group to save sub stream.

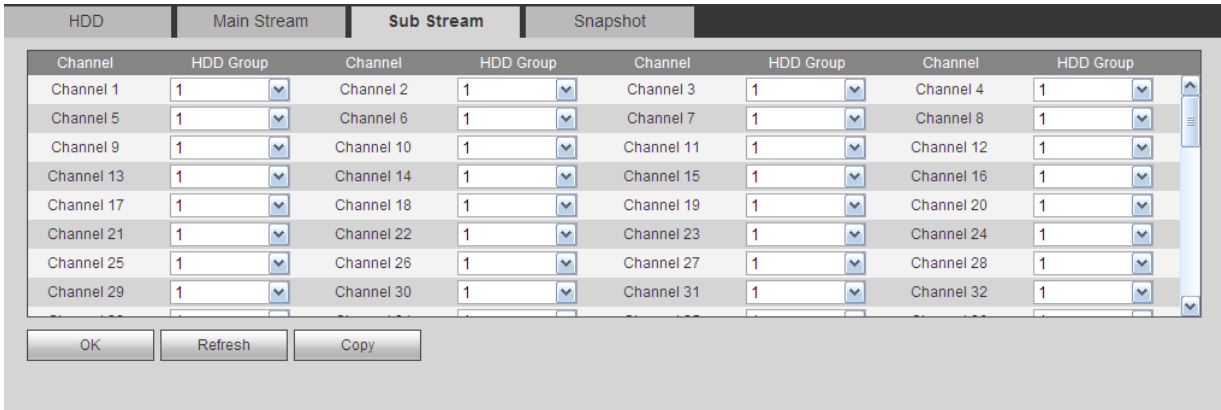

Figure 4-107

#### 4.8.4.4 Snapshot

From main menu->Setup->Storage->Advanced->Snapshot, the snapshot interface is shown as in Figure 4-108 . Here user may set corresponding HDD group to save snapshot picture.

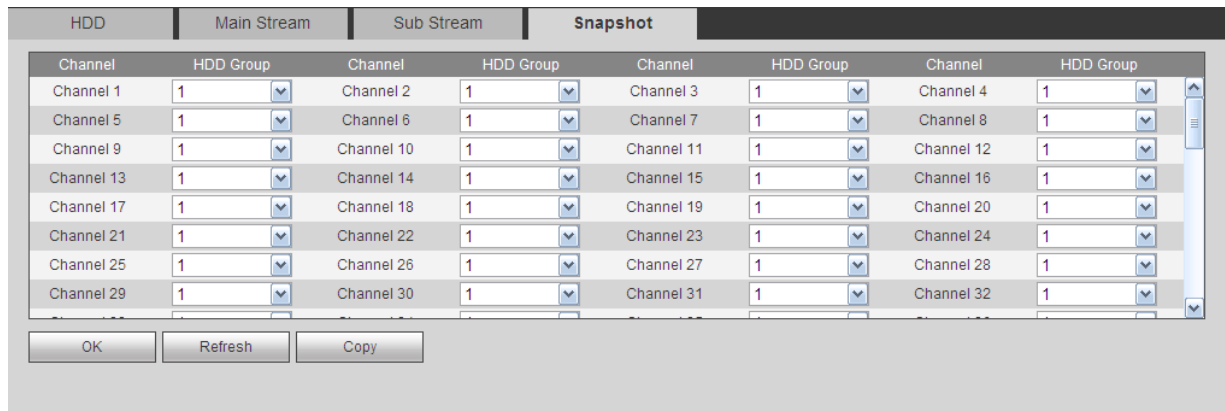

Figure 4-108

#### 4.8.4.5 RAID Manager

##### Important

**Please make sure your purchased product support the RAID function, otherwise user may not see the following interface.**

##### 4.8.4.5.1 RAID Config

From main menu->Setup->Storage->RAID->RAID config, user may go to the following interface. See Figure 4-109.

It is for you to manage RAID HDD. It can display RAID name, type, free space, total space, status and etc. Here user may add/delete RAID HDD.

Click Add button to select RAID type and then select HDDs, click OK button to add. See Figure 4-109.

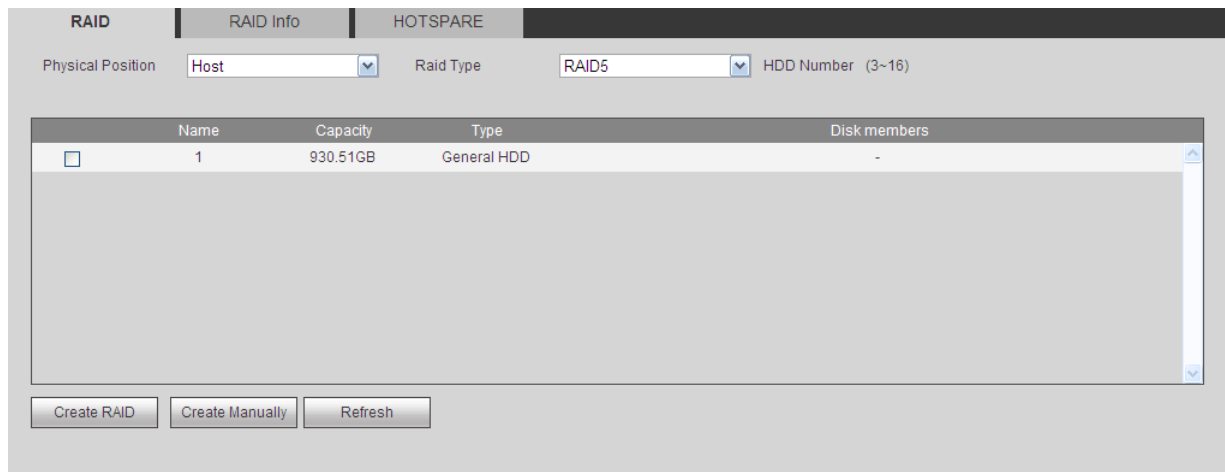

Figure 4-109

##### 4.8.4.5.2 RAID Info

From main menu->Setup->Storage->RAID->RAID info, user may go to the following interface. See Figure 4-109. Here user may view corresponding RAID information.



Figure 4-110

#### 4.8.4.5.3 Hotspare disks

From main menu->Setup->Storage->RAID->Hotspare, user may see an interface shown as in Figure 4-111. The type includes two options:

- Global: It is global hotspare disk. When any RAID becomes degrading, it can replace and build the RAID.
- Local: It is local hotspare disk. When the specified RAID becomes degrading, it can replace and build the RAID.

Select a hot spare device and then click Delete button . Click Apply button to delete.

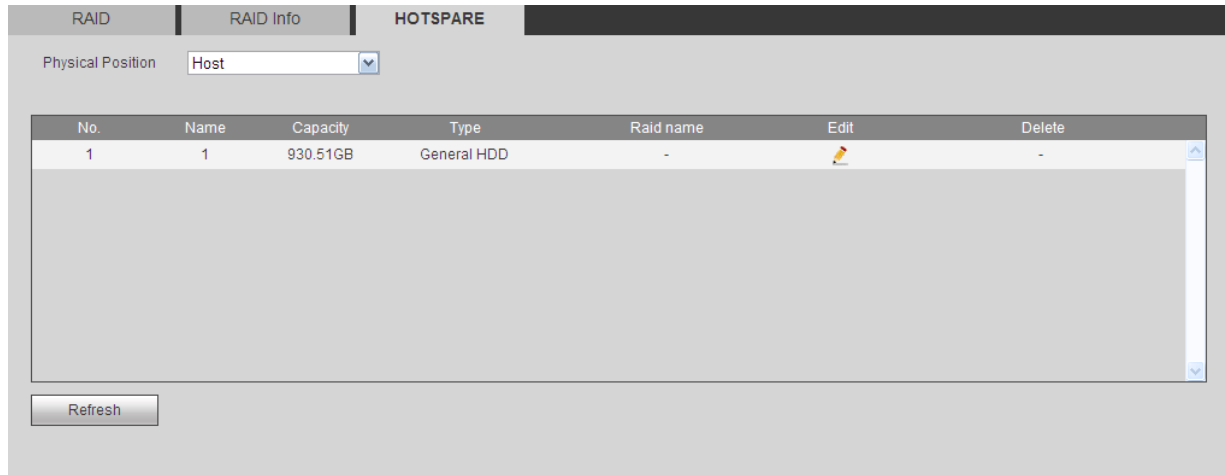

Figure 4-111

#### 4.8.4.6 iSCSI

From main menu->Setup->Storage->iSCSI, user may see an interface shown as in Figure 4-112. Here user may set corresponding HDD group to save main stream.

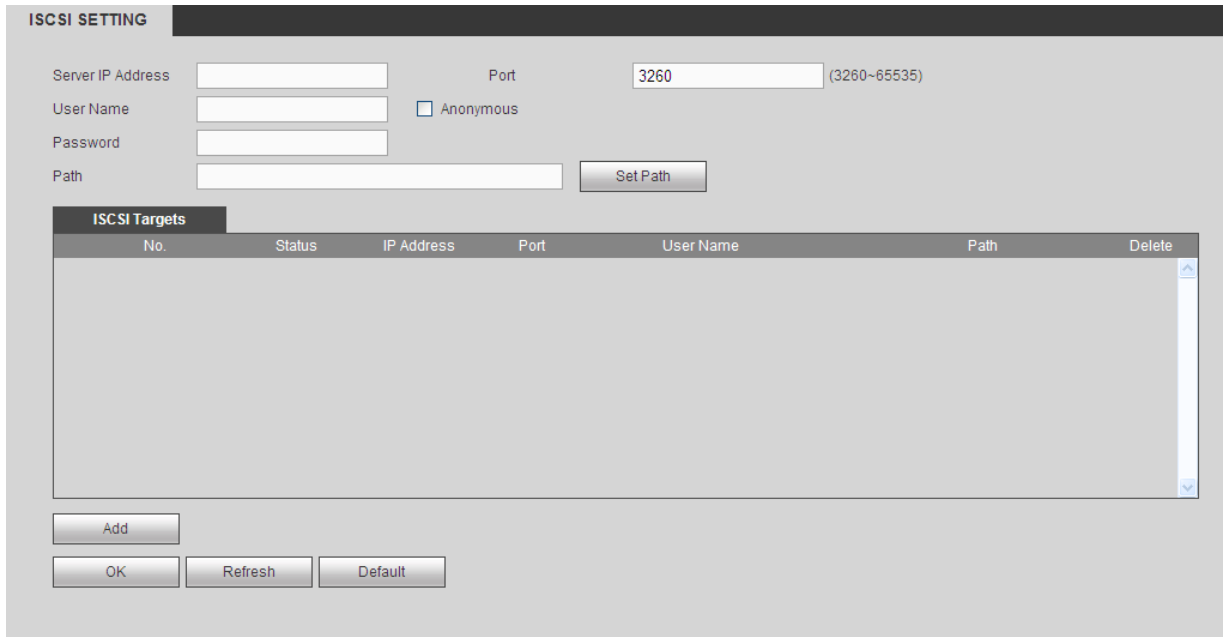

Figure 4-112

Check the box to enable iSCSI function and then input iSCSI server IP address and port. The default port number is 3260.

Click Set path button, system pops up the path setup dialogue box. Please select the connected path and then click OK button. See Figure 4-113.

Each path here stands for an iSCSI share disk. The path is already generated when it was created on the server.

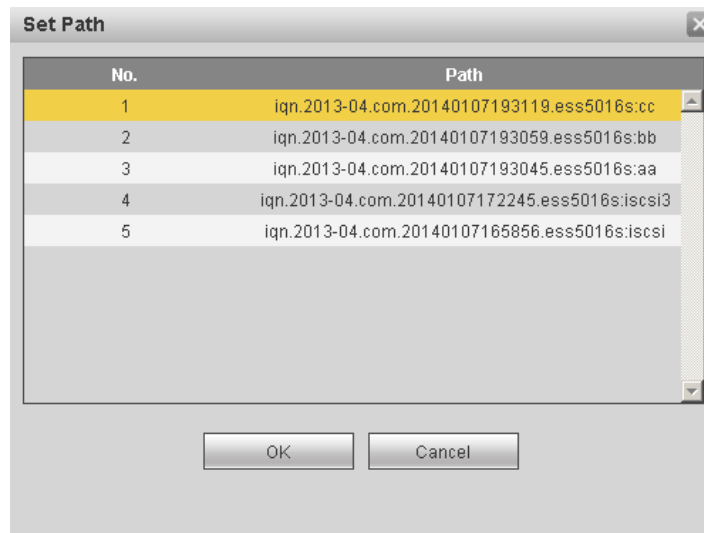

Figure 4-113

Input user name and password to set iSCSI path access right.

There are two situations:

- When you set the iSCSI server, you have set corresponding user name or password for a path. In this situation, you need to input user name or password to login.

- When you set the iSCSI server, you have not set the corresponding access right. In this situation, user may check the anonymous button or input customized user name.

Click add button, now you have added an iSCSI server. Click OK button, the setup is finish. The interface is shown as in Figure 4-114.

**Note:**

- If you have not input a user name/password, or check the anonymous button, system pops up a dialogue box to prompt you that system is going to add anonymously. In this situation, once the iSCSI path has the access setup, you may not connect to the iSCSI server.
- Since the connection may take a while, please wait a moment and then click refresh button, once the status is shown as offline after you added.

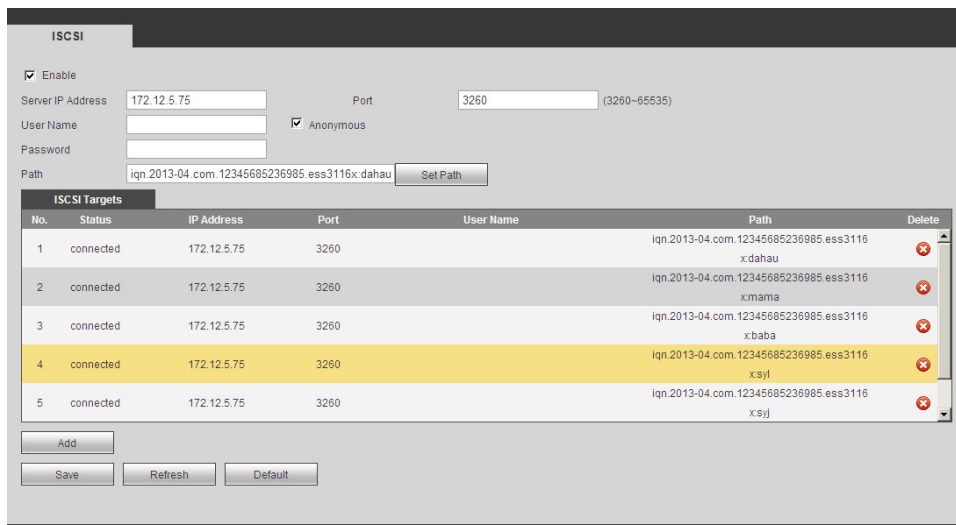

Figure 4-114

## 4.8.5 Setting

### 4.8.5.1 General

The general interface includes general, date/time and holiday setup.

#### 4.8.5.1.1 General

From main menu->Setup->System->General->General, the general interface is shown as in Figure 4-115.

The screenshot shows a configuration window with the following settings:

- Device Name: NVR
- Device No.: 8
- Language: ENGLISH
- Video Standard: PAL
- HDD Full: Overwrite
- Pack Duration: 60 min.
- Auto Logout: 10 min. (0-60)
- Startup Wizard:
- Navigation Bar:
- IPC Time Sync:  24 h

Buttons: OK, Refresh, Default

Figure 4-115

Please refer to the following sheet for detailed information.

Parameter	Function
Device ID	It is to set device name.
Device No.	It is device channel number.
Language	User may select the language from the dropdown list. <b>Please note the device needs to reboot to get the modification activated.</b>
Video Standard	This is to display video standard such as PAL.
HDD full	Here is for you to select working mode when hard disk is full. There are two options: stop recording or rewrite. If current working HDD is overwritten or the current HDD is full while the next HDD is no empty, then system stops recording, If the current HDD is full and then next HDD is not empty, then system overwrites the previous files.
Pack duration	Here is for you to specify record duration. The value ranges from 1 to 120 minutes. Default value is 60 minutes.
Auto logout	Here is for you to set auto logout interval once login user remains inactive for a specified time. Value ranges from 0 to 60 minutes.
Startup wizard	Once you check the box here, system will go to the startup wizard directly when the system restarts the next time. Otherwise, it will go to the login interface.
Navigation bar	Check the box here, system displays the navigation bar on the interface.
IPC Time Sync	User may input an interval here to synchronize the NVR time and IPC time.

4.8.5.1.2 Date and time

From main menu->Setup->System->General->Date and time, the date and time interface is shown as in Figure 4-116

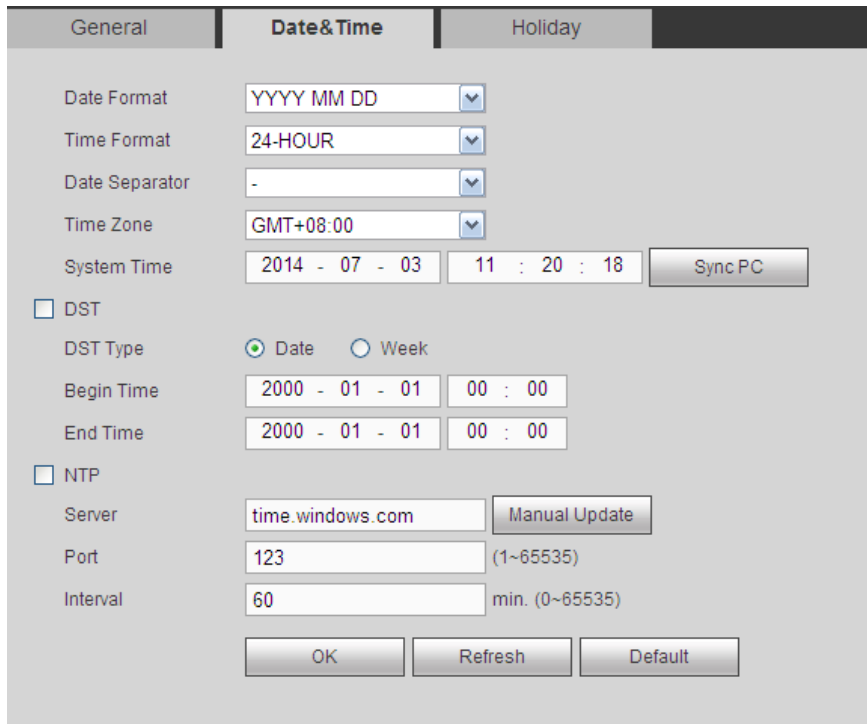



Figure 4-116

Please refer to the following sheet for detailed information.

Parameter	Function
Date format	Here user may select date format from the dropdown list.
Time Format	There are two options: 24-H and 12-H.
Time zone	The time zone of the device.
System time	It is to set system time. It becomes valid after you set.  <b>Caution</b> System time is very important! Do not change unless there is a must!
Sync PC	User may click this button to save the system time as your PC current time.
DST	Here user may set day night save time begin time and end time. User may set according to the date format or according to the week format.
NTP	User may check the box to enable NTP function.
NTP server	User may set the time server address.
Port	It is to set the time server port.
Interval	It is to set the sync periods between the device and the time server.

4.8.5.1.3 Holiday Setup



From main menu->Setup->System->General->Holiday, holiday setup interface is shown as in Figure 4-117.

Here user may click Add holidays box to add a new holiday and then click Save button to save.

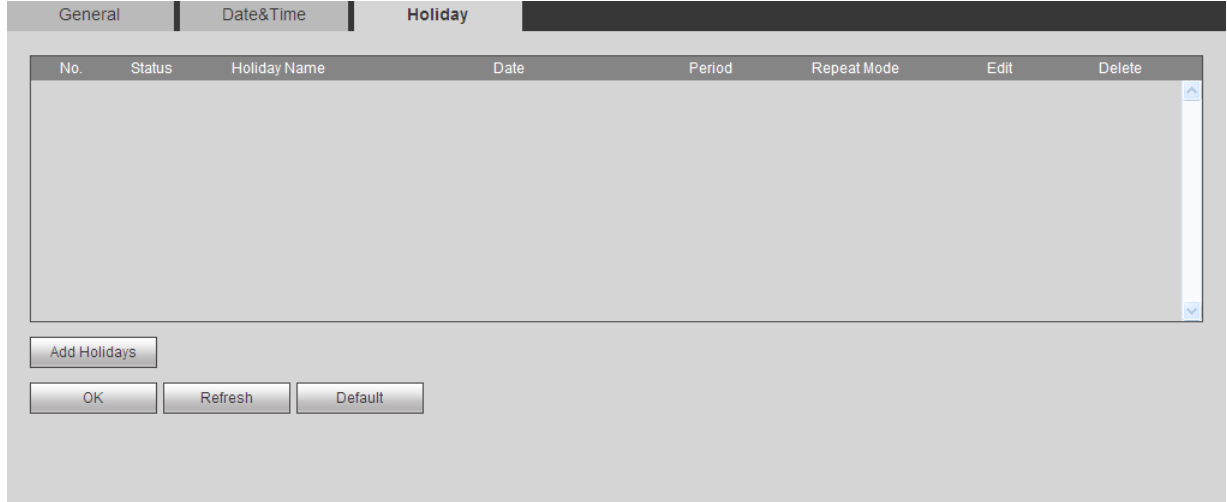

Figure 4-117

**Note**

- When you enable Holiday settings and schedule setup at the same time, holiday setting has the priority. If the selected day is a holiday, then system records as you set in holiday setting. If it is not a holiday, system records as you set in Schedule interface.
- After you successfully set holiday date, the record and snapshot period will be also shown as holiday item.

4.8.5.2 Display

Display interface includes GUI, Tour.

4.8.5.2.1 Display

From main menu->Setup->System->Display->Display, here user may set background color and transparency level. See Figure 4-118.

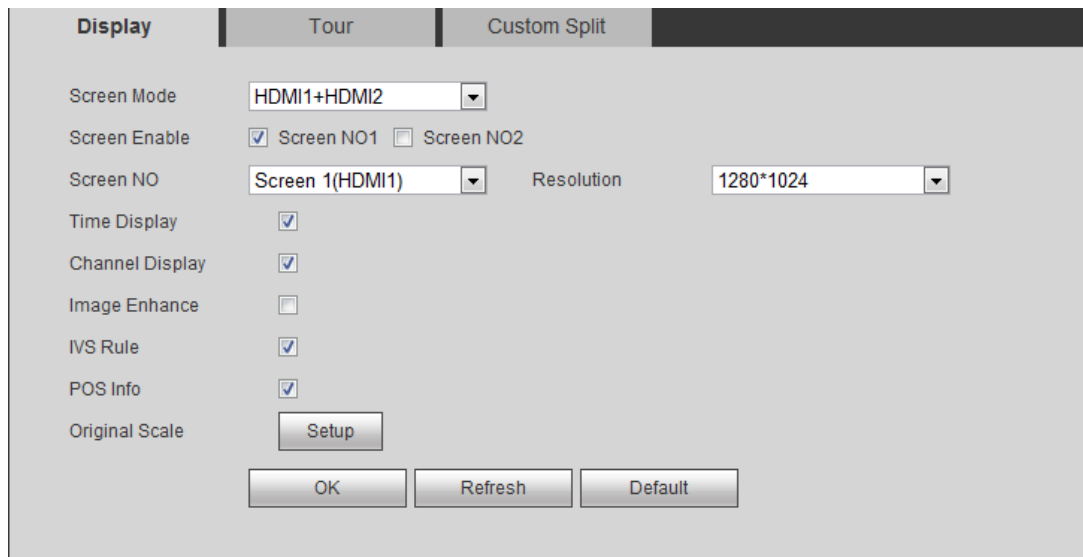

Figure 4-118

Please refer to the following sheet for detailed information.

Parameter	Function
Resolution	There are four options: 1920×1080, 1280×1024(default), 1280×720, 1024×768. Please note the system needs to reboot to activate current setup.
Transparency	Here is for you to adjust transparency. The value ranges from 128 to 255.
Time title/channel title	Check the box here, user may view system time and channel number on the monitor video.
Image enhance	Check the box; user may optimize the margin of the preview video.
POS info	Check the box here to overlay POS info on the preview interface.
Original rate	Click Setup button and then select a channel, user may restore original scale.

#### 4.8.5.2.2 Tour

From main menu->Setup->System->Display->Tour, the tour interface is shown as in Figure 4-119. Here user may set tour interval, split mode, motion detect tour and alarm tour mode.

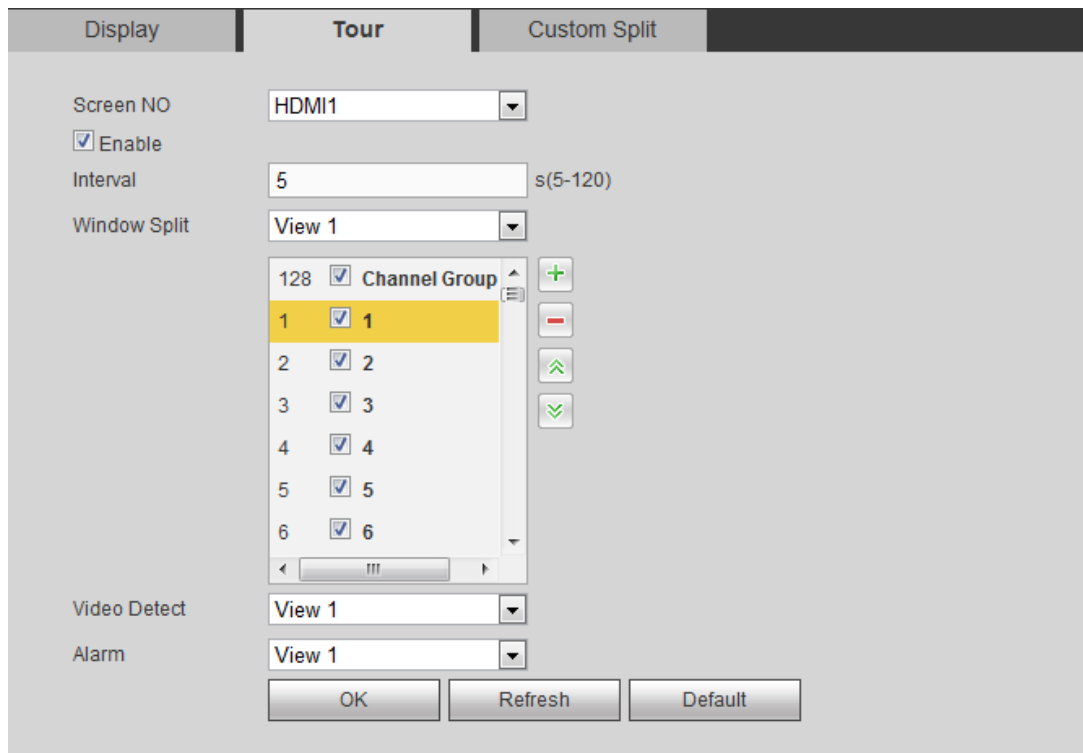

Figure 4-119

Please refer to the following sheet for detailed information.

Parameter	Function
Enable tour	Check the box here to enable tour function.
Interval	Here is for you to adjust transparency. The value ranges from 5 to 120s. The default setup is 5s.

Split	Here user may set window mode and channel group. System can support 1/4/8/9/16/25/36-window according to device channel amount.
Motion tour/Alarm tour	Here user may set motion detect tour/alarm tour window mode. System supports 1/8-window now.

#### 4.8.5.2.3 Custom Split

From main menu->Setup->System->Display->Custom split, the interface is shown as in Figure 4-119. Here user may set customized split mode.

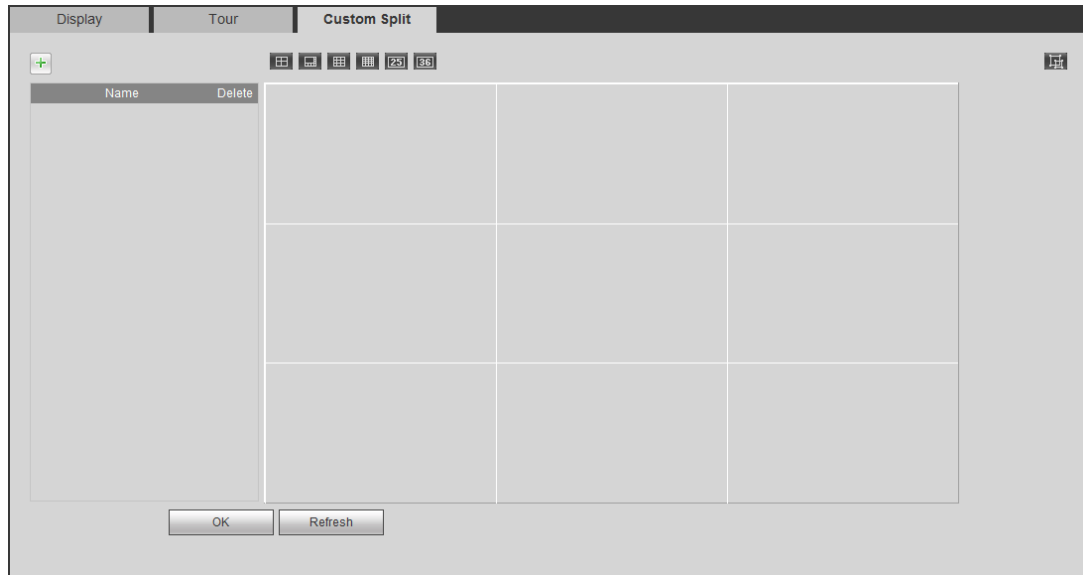

Click  and then click  to select basic mode

In regular mode, drag the mouse in the preview frame, user may merge several small windows to one window so that user may get you desired split mode.

After the setup, the selected window has the red frame.

Select the merging window, the frame is red; user may click  to cancel the merge to restore regular mode.

Click OK to exit.

#### 4.8.5.3 RS232

From main menu->Setup->System->RS232, the RS232 interface is shown as in Figure 4-120.

Figure 4-120

Please refer to the following sheet for detailed information.

Parameter	Function
Protocol	Select the corresponding dome protocol. Default setup is console.
Baud Rate	Select the baud rate. Default setup is 115200.
Data Bit	The value ranges from 5 to 8. Default setup is 8.
Stop bit	There are two options: 1/2. Default setup is 1.
Parity	There are five options: none/odd/even/space/mark. Default setup is none.

#### 4.8.5.4 PTZ

The PTZ interface is shown as in Figure 4-121 (local type) and Figure 4-122 (remote type).

Before setup, please check the following connections are right:

- PTZ and decoder connection is right. Decoder address setup is right.
- Decoder A (B) line connects with NVR A (B) line.

Click Save button after you complete setup, user may go back to the monitor interface to control speed dome.

Figure 4-121

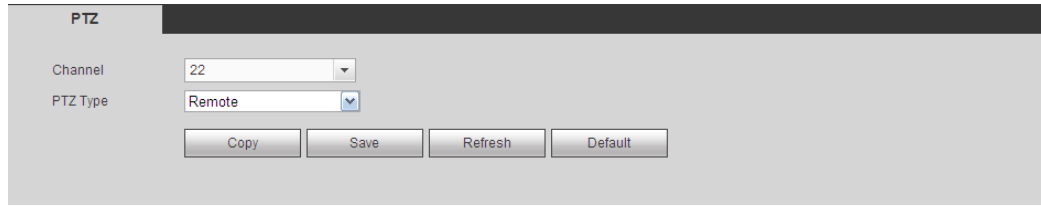

Figure 4-122

Please refer to the following sheet for detailed information.

Parameter	Function
Channel	Select speed dome connected channel.
PTZ Type	There are two options: local/remote. Please select remote type if you are connecting to the network PTZ.
Protocol	Select the corresponding dome protocol such as PELCOD.
Address	Set corresponding dome address. Default value is 1. <b>Please note your setup here shall comply with your dome address; otherwise user may not control the speed dome.</b>
Baud Rate	Select the dome baud rate. Default setup is 9600.
Data Bit	Default setup is 8. Please set according to the speed dome dial switch setup.
Stop bit	Default setup is 1. Please set according to the speed dome dial switch setup.
Parity	Default setup is none. Please set according to the speed dome dial switch setup.

#### 4.8.5.5 POS

Connect the NVR to the POS, it can receive the POS information and overlay on the corresponding record.

#### Note

POS info overlay and playback function is for 1-window only.

From main menu->Setting->System->POS, user may go to the following interface. See Figure 4-123.

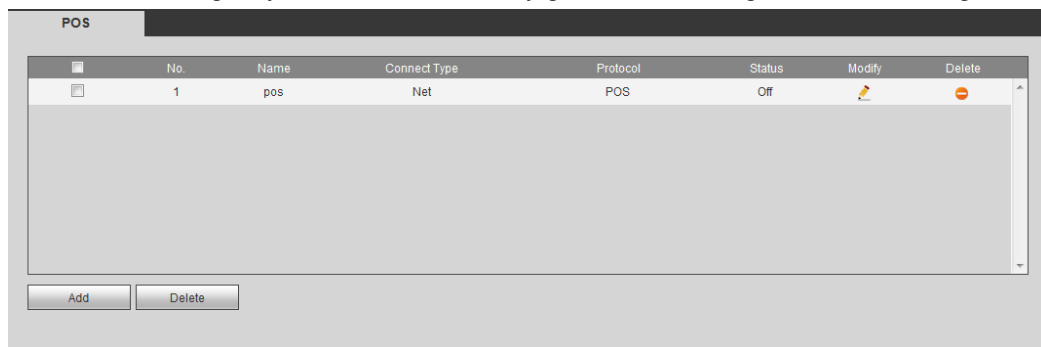

Figure 4-123

Click Add, user may see the following dialogue box. See Figure 4-124.

Figure 4-124

Check the box to enable POS function, Click Set button; user may see the following interface. See Figure 3-187.

Figure 4-125

Set source IP and destination IP, and then click OK. System goes back to Figure 4-124.

- Source IP: POS device IP address.
- Destination IP: NVR IP address.

In Figure 4-124, click Channel Set button, select the channel you want to overlay POS information. Click OK button to complete the setup.

#### Tips



: Click it to delete POS setup.



: Click it to change setup information.

#### 4.8.5.6 Account

**Note:**

- For the character in the following user name or the user group name, system max supports 6-digits. The space in the front or at the end of the string is null. The valid string includes: character, number, and underline.
- The user amount default setup is 64 and the group amount default setup is 20. The factory default setup includes two levels: user and admin. User may set the corresponding group and then set the rights for the respective user in the specified groups.
- User management adopts group/user modes. The user name and the group name shall be unique. One user shall be included in only one group.

##### 4.8.5.6.1 User name

From main menu->Setup->System->Account, user may go to the account interface. In this interface user may add/remove user and modify user name. See Figure 4-126.

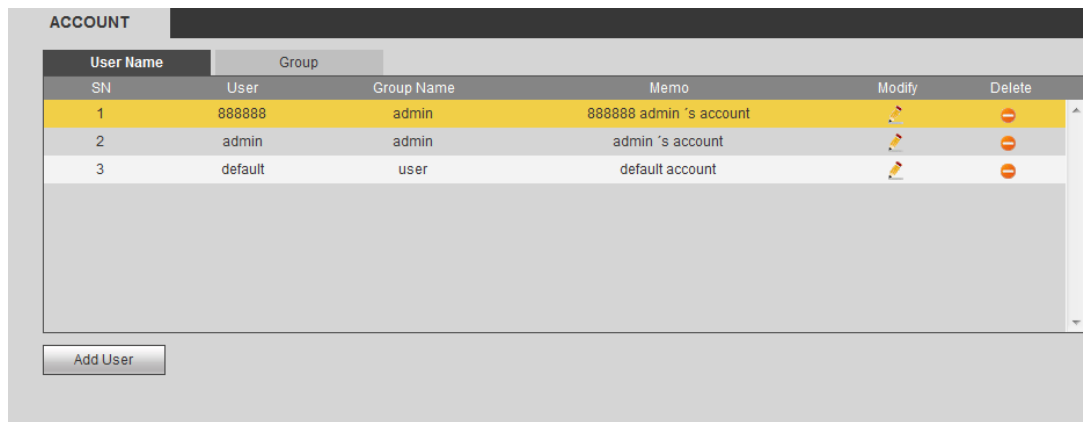

The screenshot shows a web interface titled "ACCOUNT". It features a table with columns for "User Name", "Group", "SN", "User", "Group Name", "Memo", "Modify", and "Delete". There are three rows of data. Below the table is a button labeled "Add User".

User Name		Group					
SN	User	Group Name	Memo	Modify	Delete		
1	888888	admin	888888 admin 's account				
2	admin	admin	admin 's account				
3	default	user	default account				

Figure 4-126

**Add user:** It is to add a name to group and set the user rights. See Figure 4-127.

There are three default users: admin (password: admin)/888888(password: 888888) and hidden user "default".

Hidden user "default" is for system interior use only and can not be deleted. When there is no login user, hidden user "default" automatically login. User may set some rights such as monitor for this user so that user may view some channel view without login.

Here user may input the user name and password and then select one group for current user.

Please note the user rights shall not exceed the group right setup.

For convenient setup, please make sure the general user has the lower rights setup than the admin.

Figure 4-127

**Modify user**

It is to modify the user property, belonging group, password and rights. See Figure 4-128.

**Modify password**

It is to modify the user password. You need to input the old password and then input the new password twice to confirm the new setup. Please click the OK button to save.

Please note, the password ranges from 1-digit to 6-digit. It shall include the number only. For the user of the account rights, he can modify the password of other users.



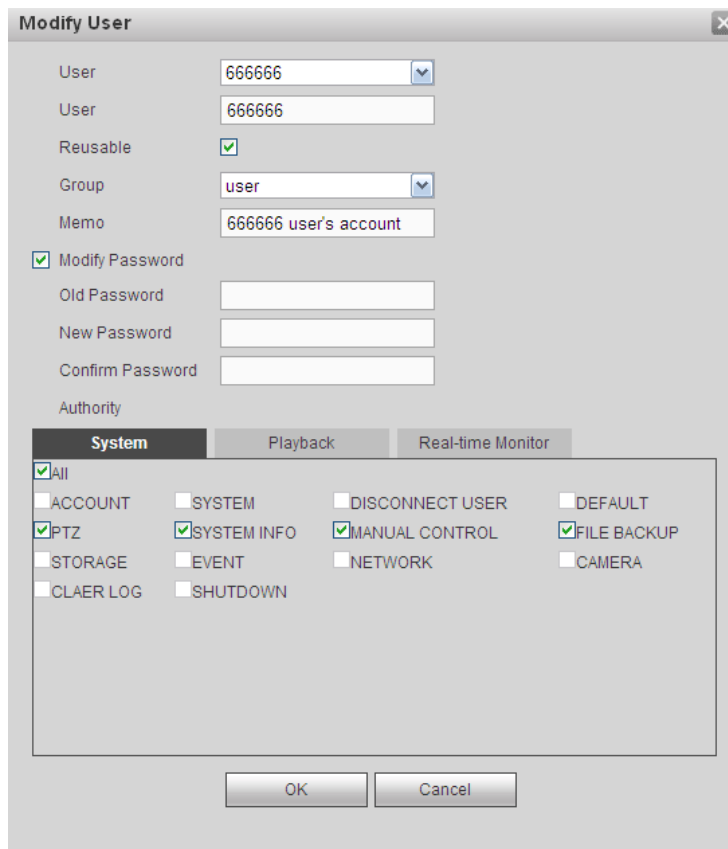

Figure 4-128

#### 4.8.5.6.2 Group

The group management interface can add/remove group, modify group password and etc. The interface is shown as in Figure 4-129.

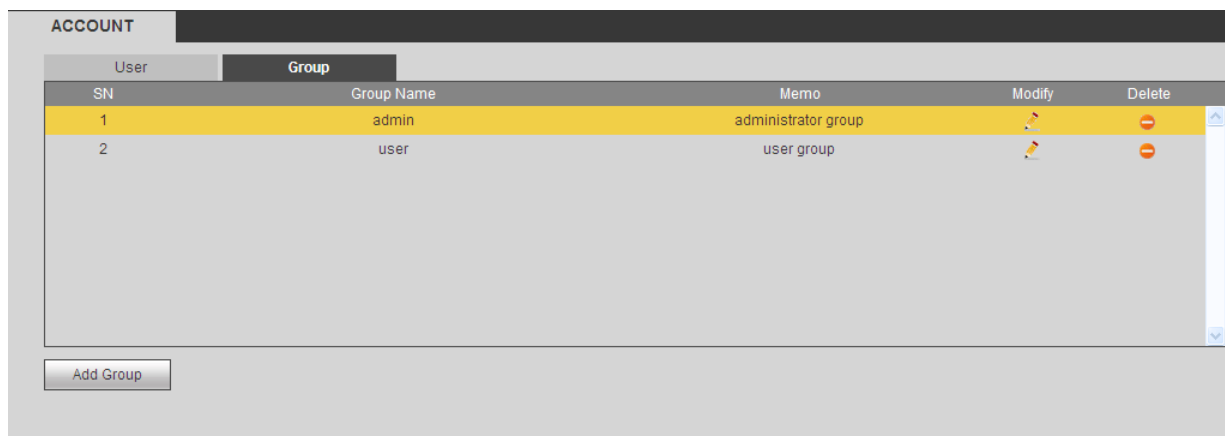

Figure 4-129

**Add group:** It is to add group and set its corresponding rights. See Figure 4-130.

Please input the group name and then check the box to select the corresponding rights. It includes: shutdown/reboot device, live view, record control, PTZ control and etc.

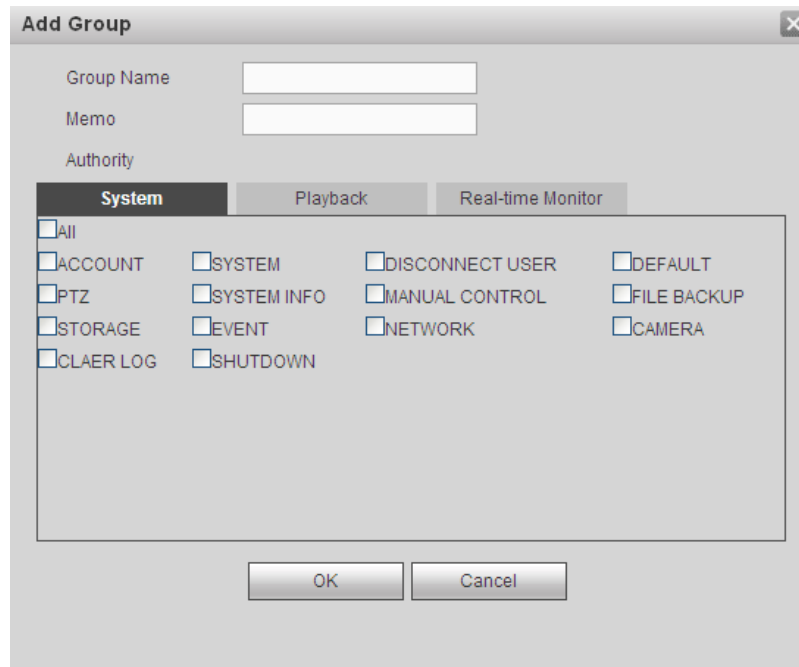

Figure 4-130

### Modify group

Click the modify group button, user may see an interface is shown as in Figure 4-131. Here user may modify group information such as remarks and rights.

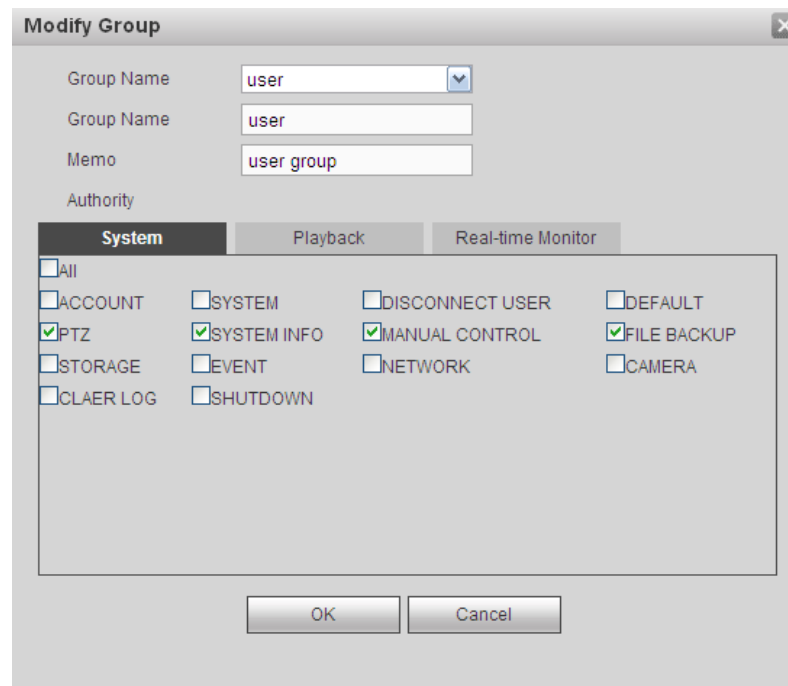

Figure 4-131

### 4.8.5.7 Auto maintain

From main menu->Setup->System->Auto maintain, the auto maintain interface is shown as in Figure 4-132.

Here user may select auto reboot and auto delete old files interval from the dropdown list.

If you want to use the auto delete old files function, you need to set the file period.  
 Click Manual reboot button, user may restart device manually.

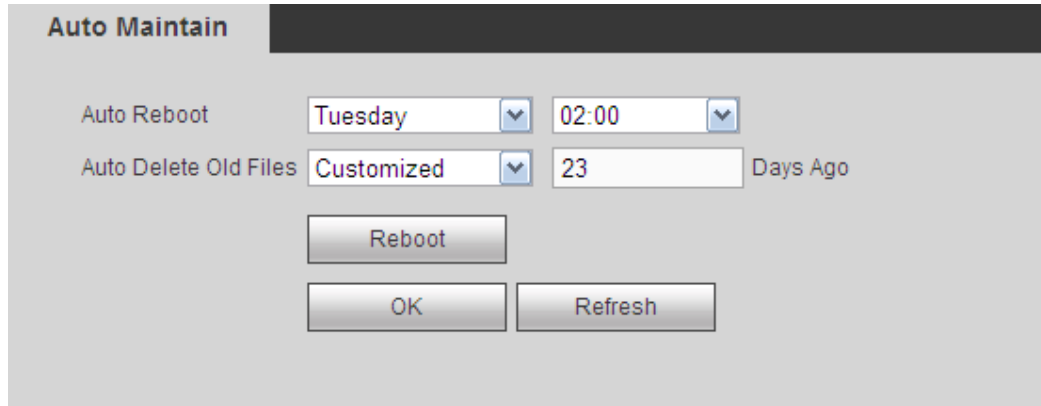

Figure 4-132

#### 4.8.5.8 Import/Export

From main menu->Setup->System->Import/export, the interface is shown as in Figure 4-133.

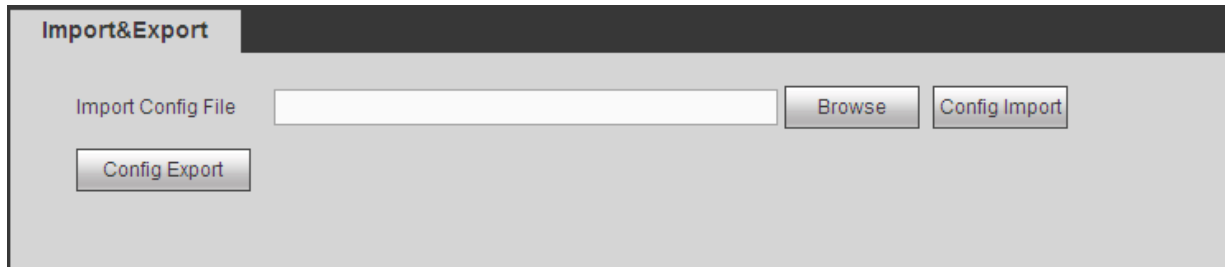

Figure 4-133

Please refer to the following sheet for detailed information.

Parameter	Function
Import	It is to import the local setup files to the system.
Export	It is to export the corresponding WEB setup to your local PC.

#### 4.8.5.9 Default

From main menu->Setup->System->Default, the default setup interface is shown as in Figure 4-134.

Here user may select Network/Event/Storage/Setting/Camera. Or user may check the All box to select all items.

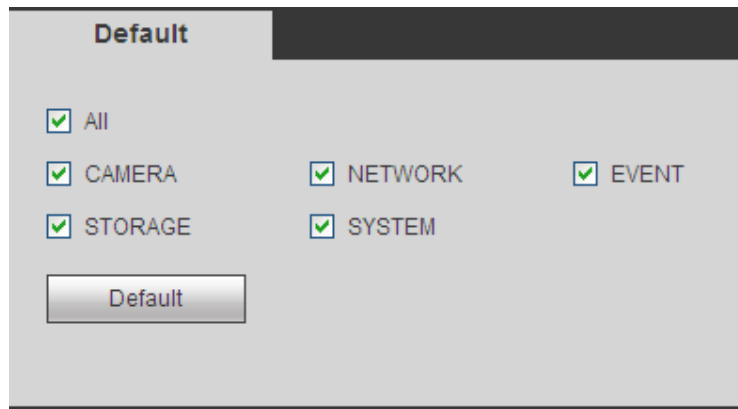

Figure 4-134

#### 4.8.5.10 Upgrade

From main menu->Setup->System->upgrade, the upgrade interface is shown as in Figure 4-135.

Please select the upgrade file and then click the update button to begin update. Please note the file name shall be as \*.bin. During the upgrade process, do not unplug the power cable, network cable, or shutdown the device.

#### **Important**

**Improper upgrade program may result in device malfunction! Please make sure the operation is operated under the DNAvision of the professional engineer!**

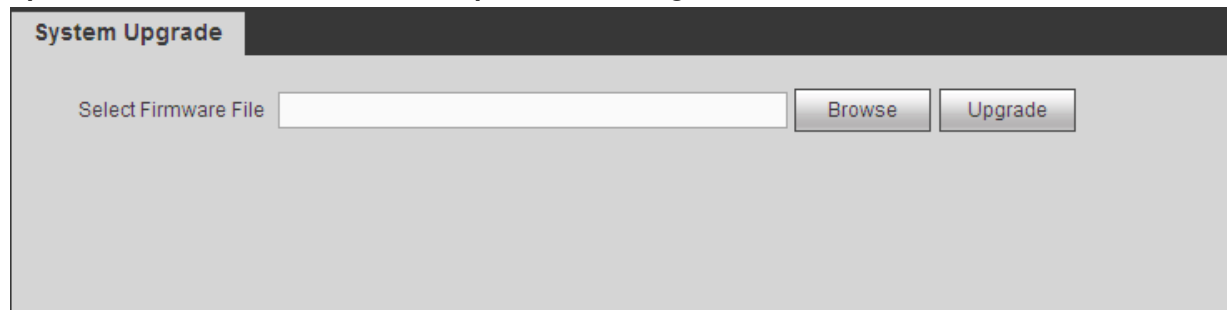

Figure 4-135

### 4.8.6 Cluster Service

The Cluster service is a system component used to control activities on a single node. When one or several device(s) are malfunction, it can switch to the slave device to replace the work accordingly.

There are two standards when the master device is malfunction: 1) Device is offline. 2) Device storage is damaged.



#### **Important**

Please go to the **WEB of the slave device** to set the cluster setup of the master device and slave device .

#### 4.8.6.1 Cluster IP

About Cluster service: when master device is malfunction, the slave device can use the master device configuration and virtual IP address to replace the work (monitor or record) accordingly. When you use

the virtual IP to access the device, he can still view the real-time video and there is no risk of record loss. Once the master device becomes properly, the slave can still work until you use the WEB to fix manually. During the whole process (the master device is working properly->master device is malfunction->master device becomes work properly again), user may use this virtual IP to access the device all the time.

After you set the right cluster IP, user may use the cluster IP to login the device. See Figure 4-136.



The screenshot shows a web interface titled "Set Cluster IP". It features a checkbox labeled "Enable". Below it are three input fields: "IP Address", "Subnet Mask", and "Default Gateway", each containing the text "0 . 0 . 0 . 0". At the bottom of the form are three buttons: "OK", "Refresh", and "Default".

Figure 4-136

**Note:**

The first IP is for cluster internal control (For interactive communications between the master device and slave device .), the virtual IP address is for cluster external control (For external network connection).

4.8.6.2 Master Device

From main menu->Setup->Cluster service->Master device, user may go to the following interface. See Figure 4-137.

In this interface, user may add several master devices manually. After you enable the cluster function, user may view device IP, work status. Click operation button, user may view the connection log of the main device. See Figure 4-137.

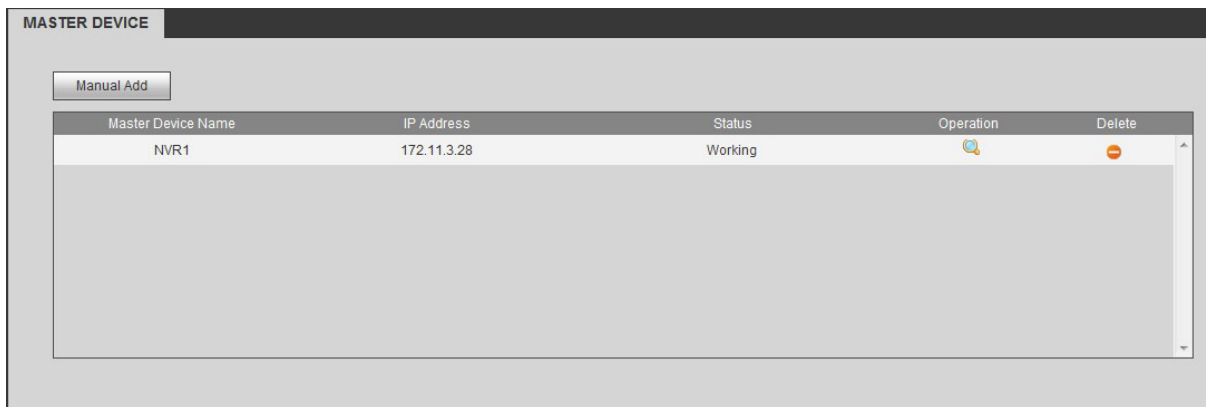

The screenshot shows a web interface titled "MASTER DEVICE". It has a "Manual Add" button. Below it is a table with the following data:

Master Device Name	IP Address	Status	Operation	Delete
NVR1	172.11.3.28	Working		

Figure 4-137

Click Manual add, the interface is shown as below. See Figure 4-138.

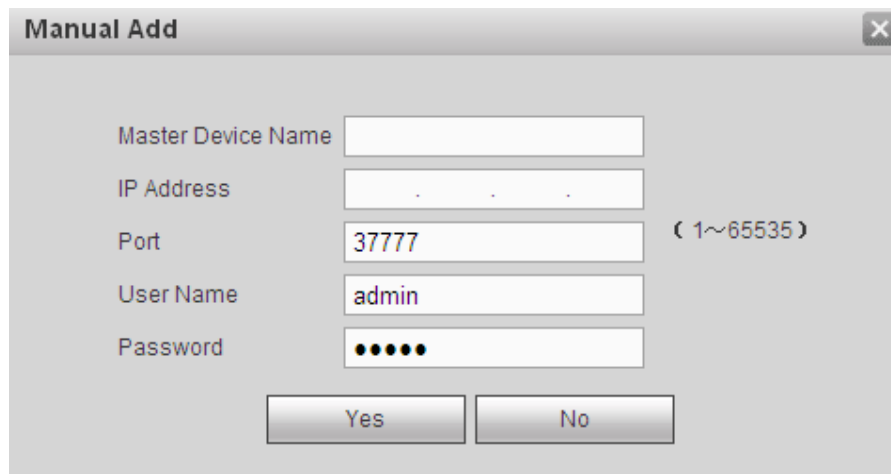

The 'Manual Add' dialog box contains the following fields and controls:

- Master Device Name:
- IP Address:
- Port:  ( 1~65535 )
- User Name:
- Password:
- Buttons: Yes, No

Figure 4-138

Click  to view event occurrence time, name, operation and reason. See Figure 4-139.

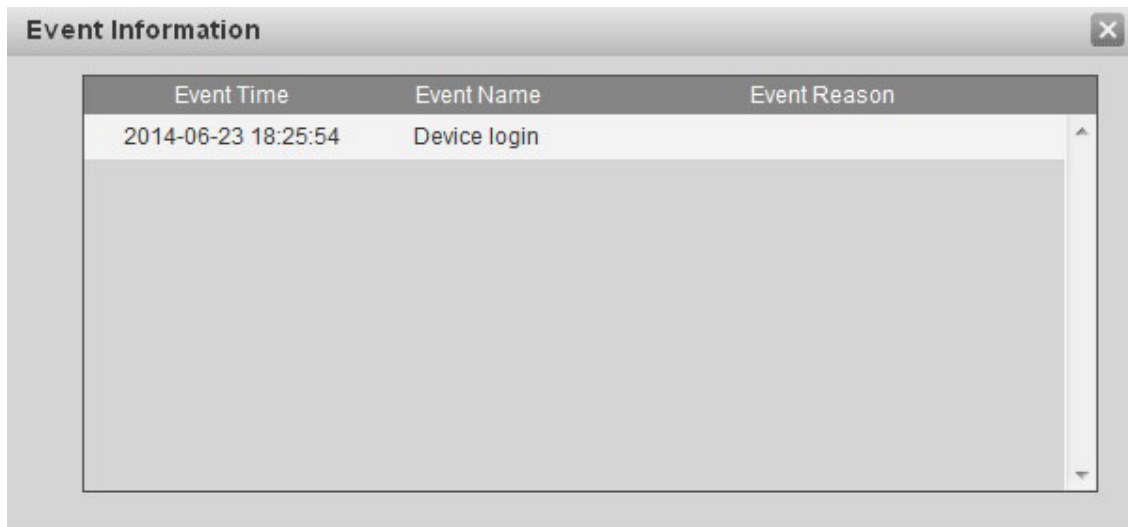

The 'Event Information' dialog box displays a table with the following data:

Event Time	Event Name	Event Reason
2014-06-23 18:25:54	Device login	

Figure 4-139

#### 4.8.6.3 Slave Device

When you add the first slave device , the default IP is the device IP address that logins in the WEB. From main menu->Setup->Cluster service->Slave device, user may go to the following interface. See Figure 4-140. User may refer to Chapter 4.8.6.1 to set.

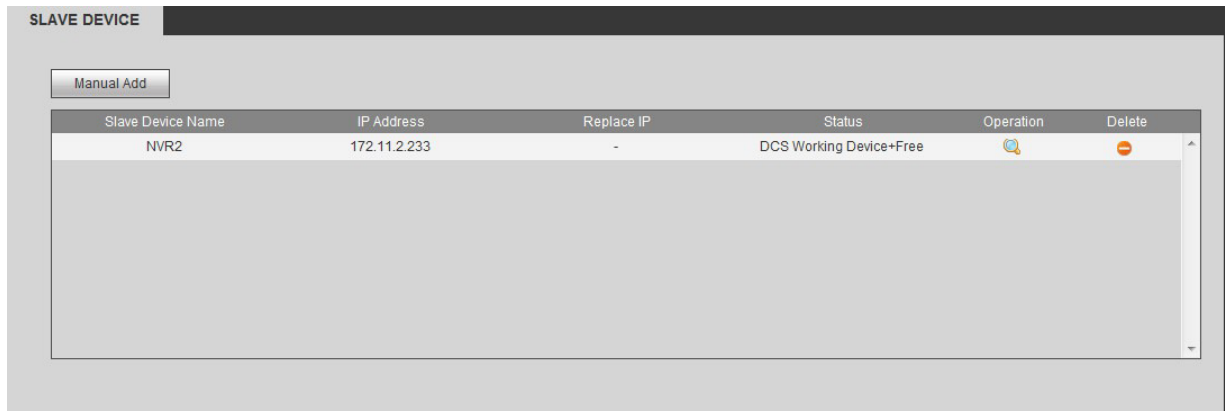

Figure 4-140

After you added master device and slave device , you need to enable cluster function. Otherwise, cluster function is null. Please refer to chapter 4.8.6.5.

#### 4.8.6.4 Record Transfer

From main menu->Setup->Cluster service->Record transfer, user may go to the record transfer interface.

When the master device is malfunction and can not record, system can use slave device to record instead. User may use this function to forward the record files on the slave device to the main device.

After the master device is malfunction, the slave device becomes active and status is used.

After the master device becomes active again, there is a button on the left side of the master device

. is the resume button.



If you want to switch the slave device to the main device, please click button manually to resume the main device. User may see the following prompt. See Figure 4-141.

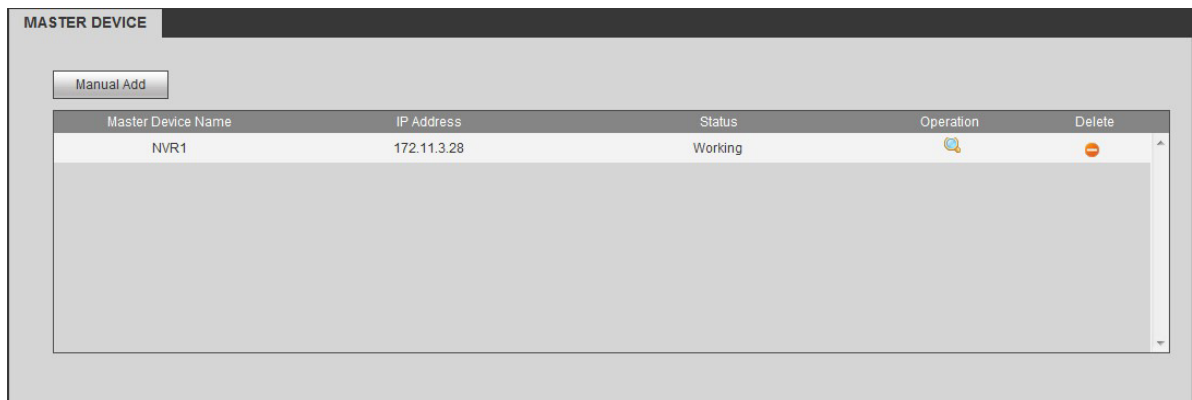

Figure 4-141

After the master device becomes active again, system can forward the record files on the slave device to the master device.

From Setup->Cluster->Record transfer, user may go to the following interface. See Figure 4-142.

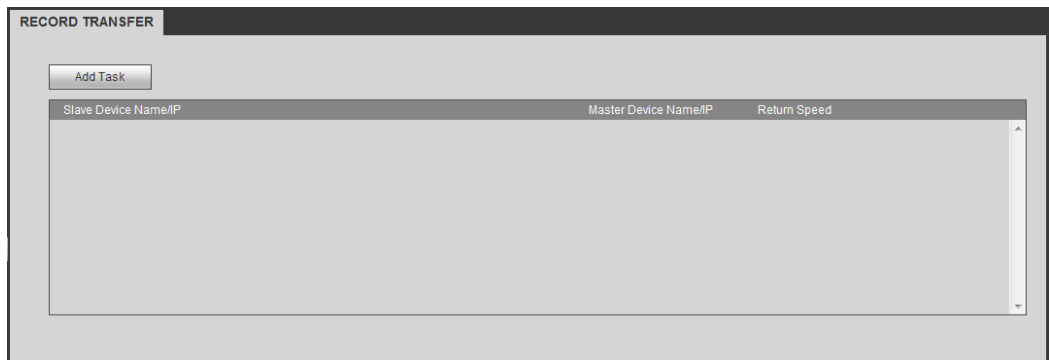

Figure 4-142

Click Add task button, user may go to the following interface to set device IP, channel, start time, end time See Figure 4-143.

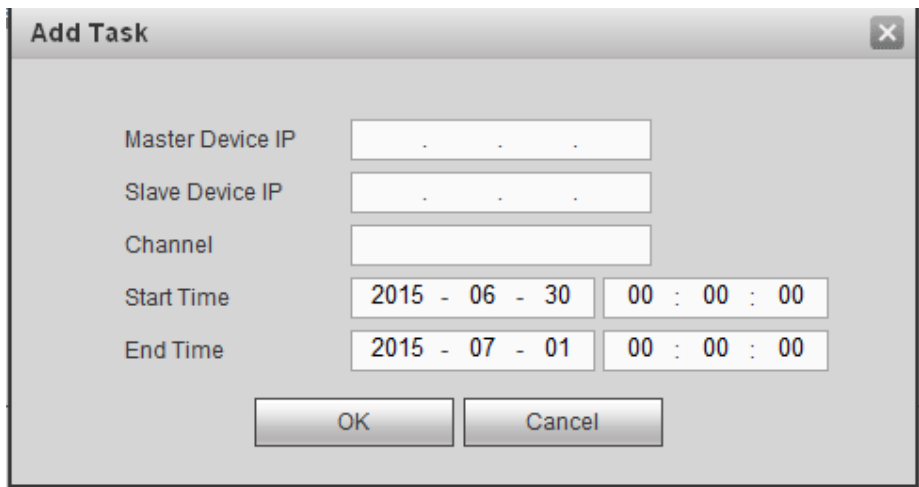

Figure 4-143

#### 4.8.6.5 Cluster control

##### 4.8.6.5.1 Cluster control

From main menu->Setup->Cluster service->Cluster control I-> Cluster control, user may go to the cluster control interface. It is to enable/disable cluster. See Figure 4-144.

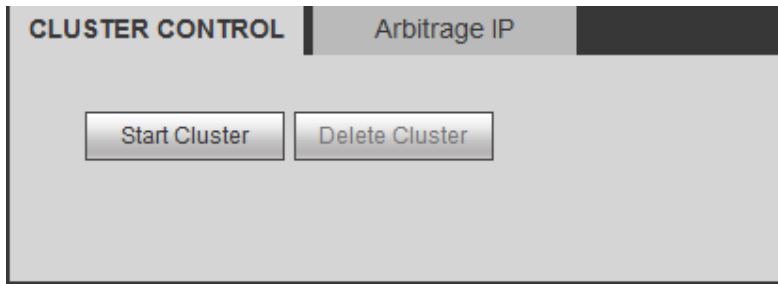



Figure 4-144

User may see the corresponding prompt if you successfully enabled cluster service.

#### 4.8.6.5.2 Arbitration IP

When there is only two NVRs in the cluster, user may set the arbitration IP to change the cluster accordingly. The arbitration IP is the IP address of other device/PC/gateway that can connect to the NVR. From main menu->Setup->Cluster service->Cluster control-> Arbitration IP, user may see the following interface. See Figure 4-145.

The screenshot shows a web interface for configuring the Arbitrage IP. The title bar reads 'Arbitrage IP' and the main header is 'CLUSTER CONTROL'. There are two input fields: 'Main IP' and 'Spare IP', each containing three dots as a placeholder. Below these fields are two buttons: 'OK' and 'Refresh'.

Figure 4-145

#### 4.8.6.6 DCS Log

From main menu->Setup->Cluster service->DCS log, user may go to the DCS log interface.

The DCS log interface is shown as in Figure 4-146. Here user may search and view the DCS log.

The screenshot displays the DCS LOG interface. At the top, there are 'Begin Time' and 'End Time' fields set to '2014 - 07 - 03 00 : 00 : 00' and '2014 - 07 - 04 00 : 00 : 00' respectively. A 'Search' button is present, followed by the text 'Matched 0 logs' and 'Record Time 2014-07-03 00:00:00 ~ 2014-07-04 00:00:00'. Below this is a table with columns 'No.', 'Time', and 'Event'. The table is currently empty. At the bottom, there is a 'DCS Log Information' section and a pagination control showing '1 / 1' and 'Go To 1'.

Figure 4-146

## 4.9 Info

From main menu->Info, user may go to the following interface.

### 4.9.1 Version

From main menu->Info->Version, the version interface is shown as in Figure 4-147.

Here user may view record channel, alarm input/output information, software version, release date and etc. **Please note the following information for reference only.**

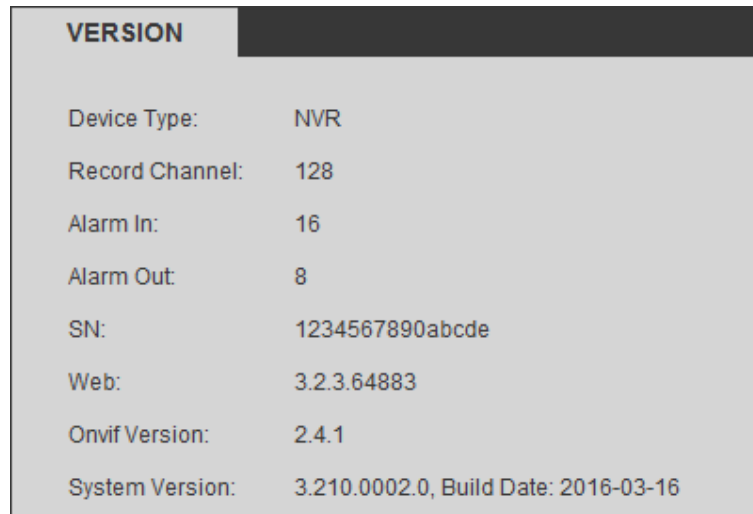

Figure 4-147

#### 4.9.2 Log

From main menu->Info->Log, here user may view system log. See Figure 4-148.

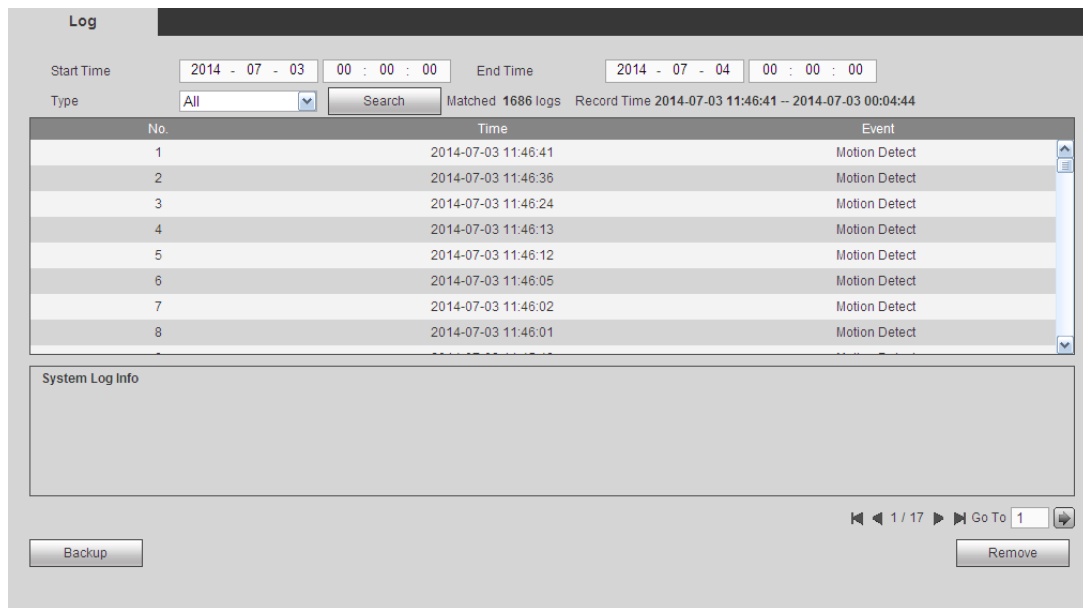

Figure 4-148

Please refer to the following sheet for log parameter information.

Parameter	Function
Type	Log types include: system operation, configuration operation, data operation, event operation, record operation, and user management, log clear.
Start time	Set the start time of the requested log.

Parameter	Function
End time	Set the end time of the requested log.
Search	User may select log type from the drop down list and then click search button to view the list. User may click the stop button to terminate current search operation.
Detailed information	User may select one item to view the detailed information.
Clear	User may click this button to delete all displayed log files. Please note system does not support clear by type.
Backup	User may click this button to backup log files to current PC.

### 4.9.3 Online User

From main menu->Info->online users, the online user interface is shown as in Figure 4-149.

User may view current online user name. User may click Refresh button to view the latest information.

The screenshot shows a web interface titled 'Online User'. It contains a table with the following data:

No.	User Name	Group Name	IP Address	User Login Time
1	admin	admin	10.15.6.140	2014-07-03 09:30:12
2	admin	admin	10.15.6.200	2014-07-03 10:50:31
3	admin	admin	10.15.6.244	2014-07-01 19:25:05
4	admin	admin	10.15.6.188	2014-07-03 10:55:17
5	admin	admin	10.15.6.188	2014-07-03 10:55:17

Below the table is a 'Refresh' button.

Figure 4-149

### 4.9.4 Video Analytics

It is to search the video analytics of each channel.

From main menu->Info->Video Analytics, the interface is shown as in Figure 4-150.

Input start time, end time, select channel and then click Search button. User may see the corresponding results.

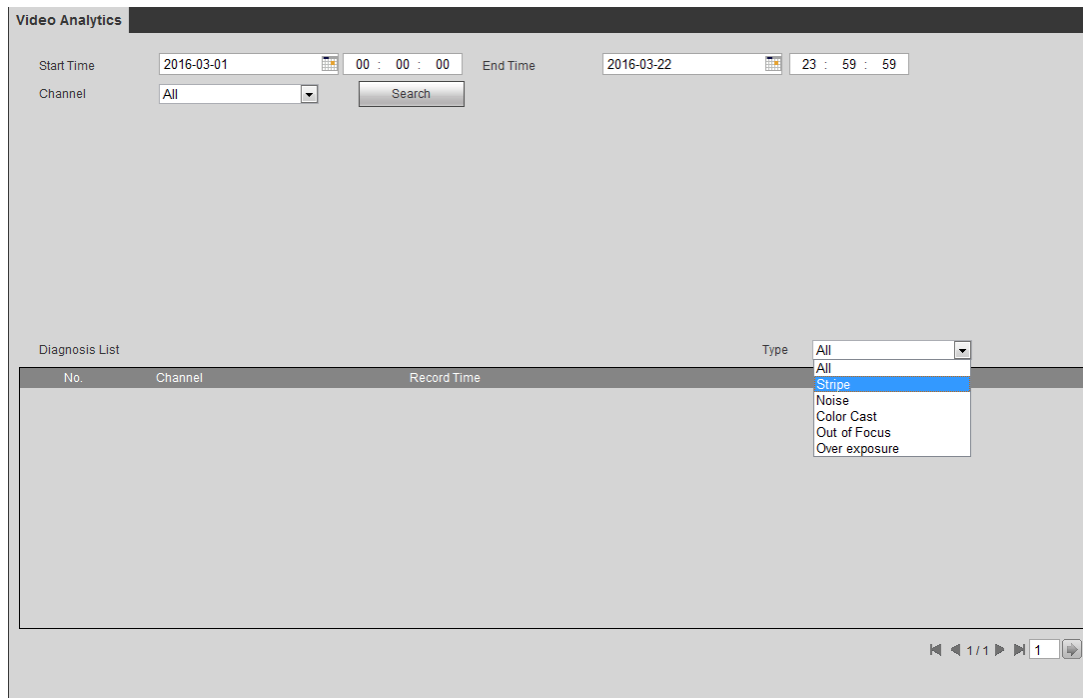

Figure 4-150

### 4.9.5 People Counting

From main menu->Info->People counting, the interface is shown as in Figure 4-151.

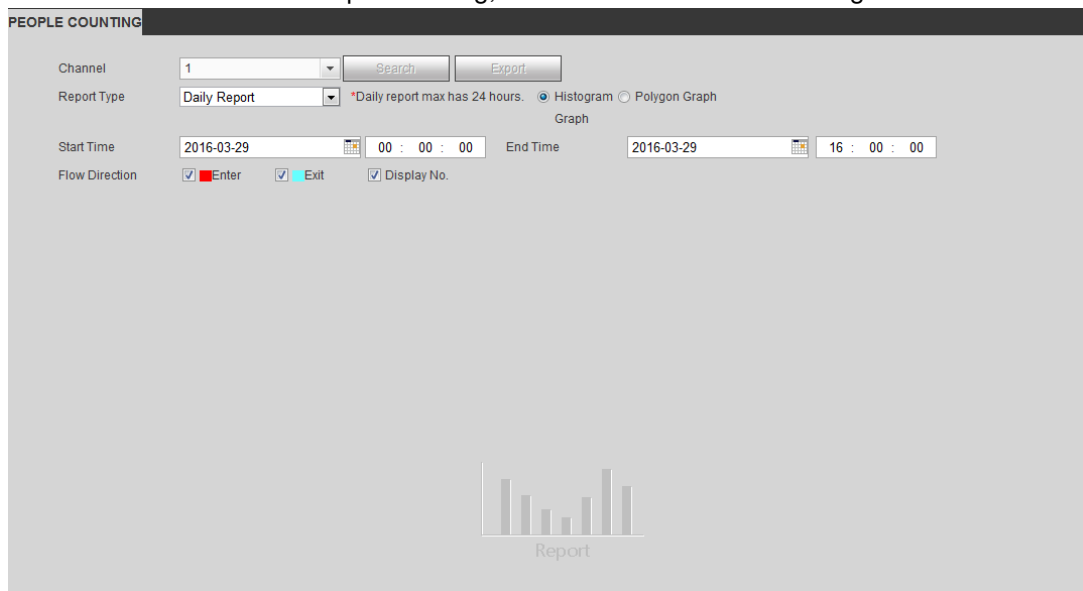

Figure 4-151

### 4.9.6 Heat Map

From main menu->Info->Heat Map, the interface is shown as in Figure 4-152.

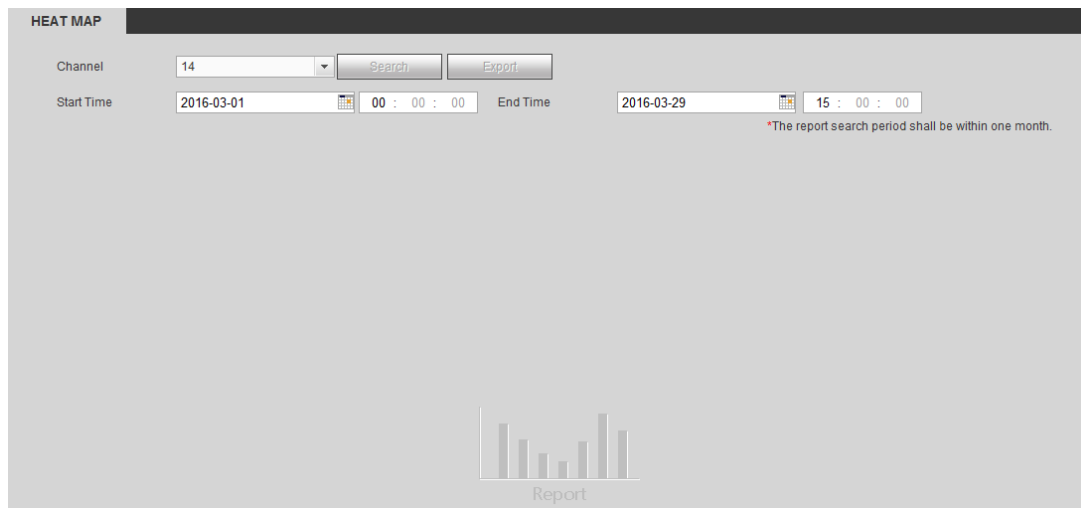

Figure 4-152

### 4.9.7 HDD

From main menu->Info->HDD, the HDD interface is shown as in Figure 4-153. Here user may view HDD information.

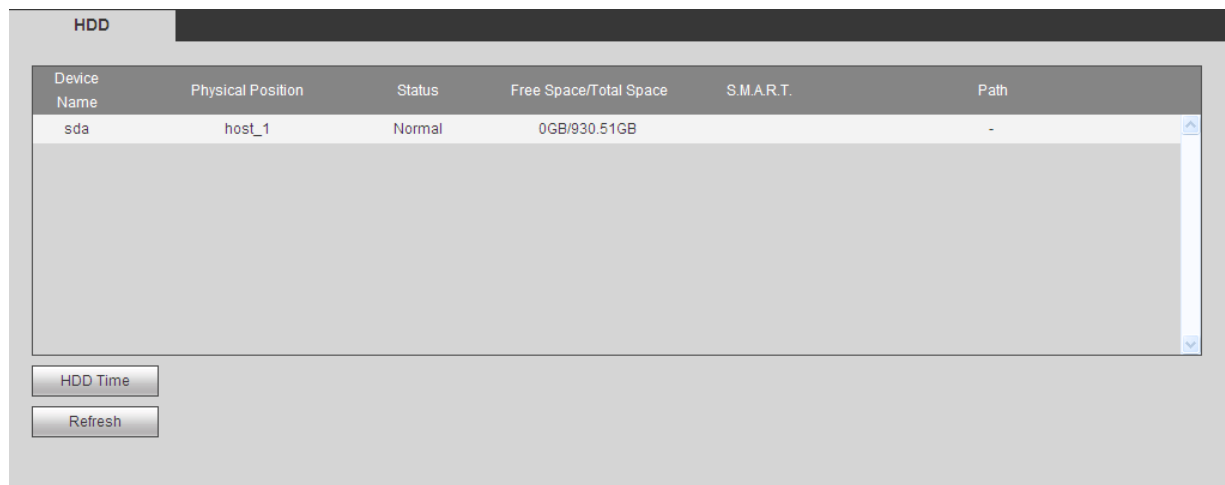

Figure 4-153

### 4.10 Playback

Click Playback button, user may see an interface is shown as in Figure 4-154.

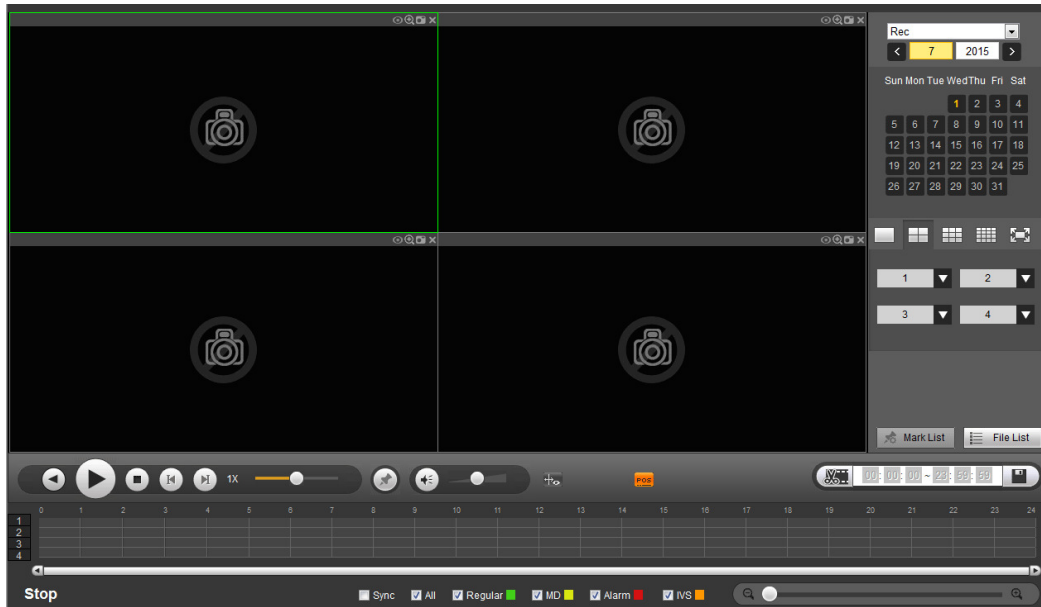

Figure 4-154

#### 4.10.1 Search record

Please set record type, record date, window display mode and channel name.

##### Select date

User may click the date on the right pane to select the date. The green highlighted date is system current date and the blue highlighted date means it has record files.

##### Window display mode

Now user may select window display mode. Click  to view the full-screen. Click Esc on the keyboard to exit full-screen.



##### Channel

User may select channel 1-n (n=device max channel amount). A1-An means sub stream.

##### Record type

Check the box to select record type. See Figure 4-155.



Figure 4-155

##### IVS rule

On the 1-window playback mode, click  to hide or display IVS rule.

##### POS info

On the 1-window playback mode, click  to hide or display POS information.

## Slice

In Figure 4-154, select splice from the dropdown list at the top right corner, and then select date, split mode and channel(s).

## Note

Select split mode, so that the record can be spliced in several sections.

Select splice file.

- Click Playback, system playbacks from the first of current date by default.
- Click time bar, system playbacks from the time you click.
- Click , user may select on the file list.

## Note

- System can auto slice file of one channel into 4/8/16 sections and then play at the same time.
- User may select channel mode to set splice amount. There is no splice operation if you select 1-window.
- The record min file size is 5 minutes.

### 4.10.2 File List

Then please click File list button, user may see the corresponding files in the list. See Figure 4-156.

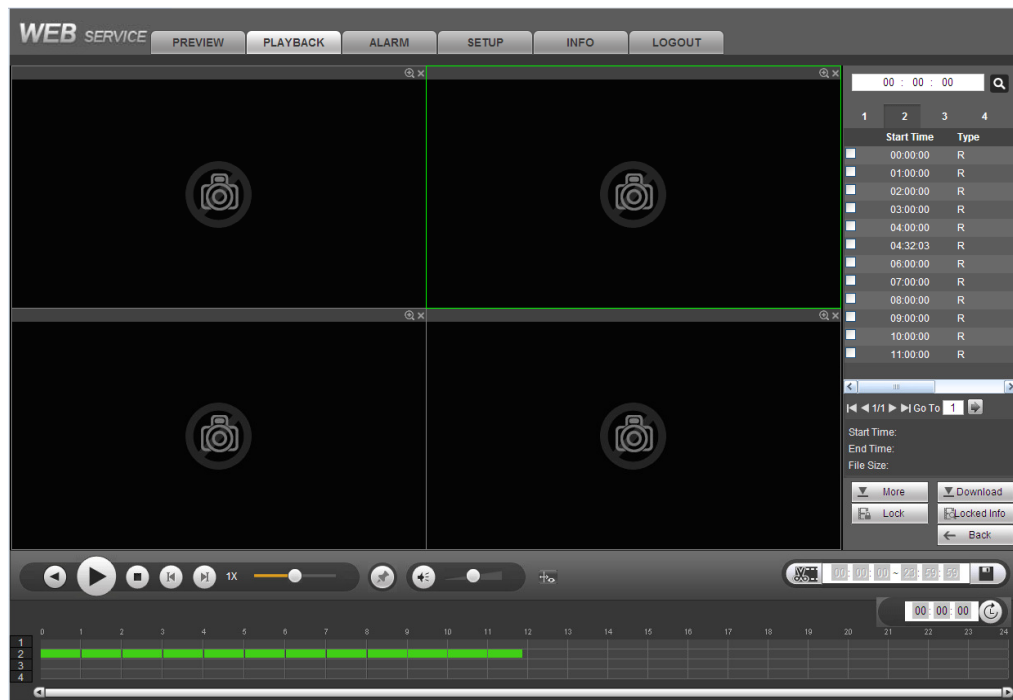

Figure 4-156

### 4.10.3 Playback

Select a file you want to play and then click Play button, system can begin playback. User may select to playback in full-screen. Please note for one channel, system can not playback and download at the same time. User may use the playback control bar to implement various operations such as play, pause, stop, slow play, fast play and etc. See Figure 4-157.

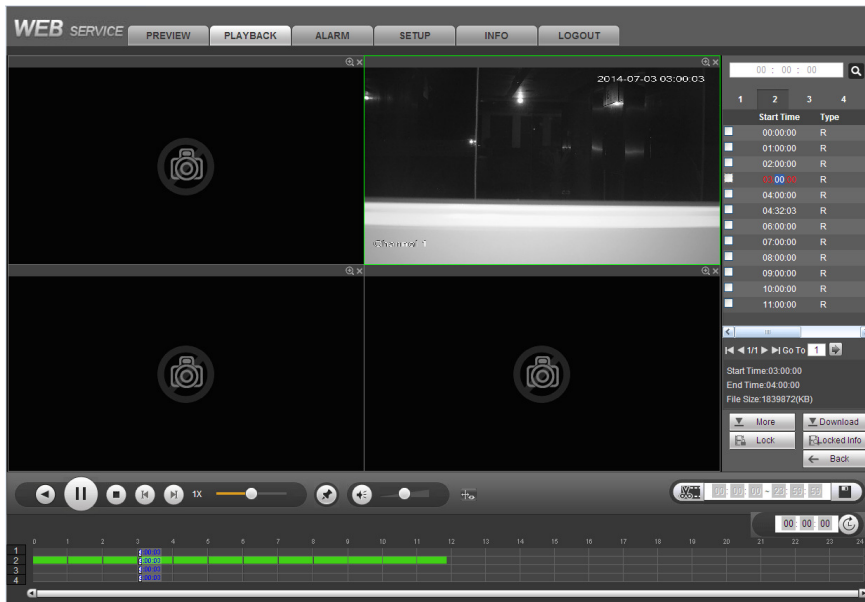

Figure 4-157

#### 4.10.4 Download

Select the file(s) you want to download and then click download button, user may see an interface shown as in Figure 4-158. The Download button becomes Stop button and there is a process bar for your reference. Please go to you default file saved path to view the files.

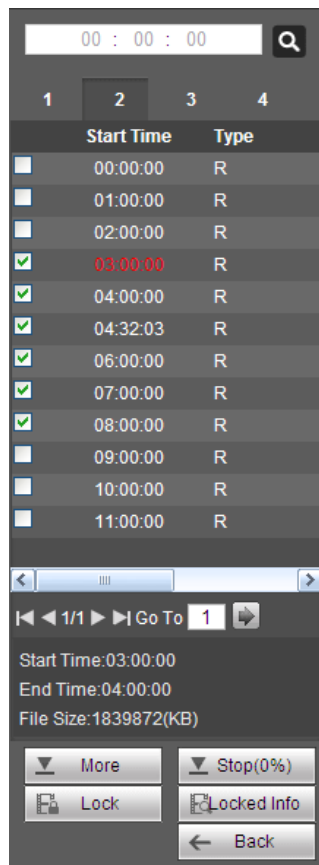

Figure 4-158



## 4.10.5 Load more

### Download by time/file

Click More button in Figure 4-158, user may see an interface shown as in Figure 4-159. It is for you to search record or picture. User may select record channel, record type and record time to download. There are two download types. The download by file interface is shown as in Figure 4-159 and the download by time interface is shown as in Figure 4-160.

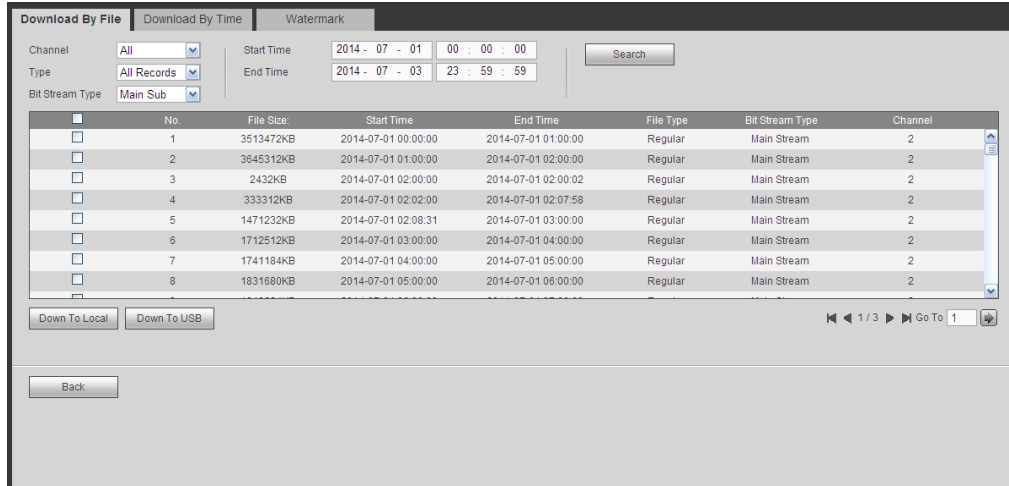

Figure 4-159

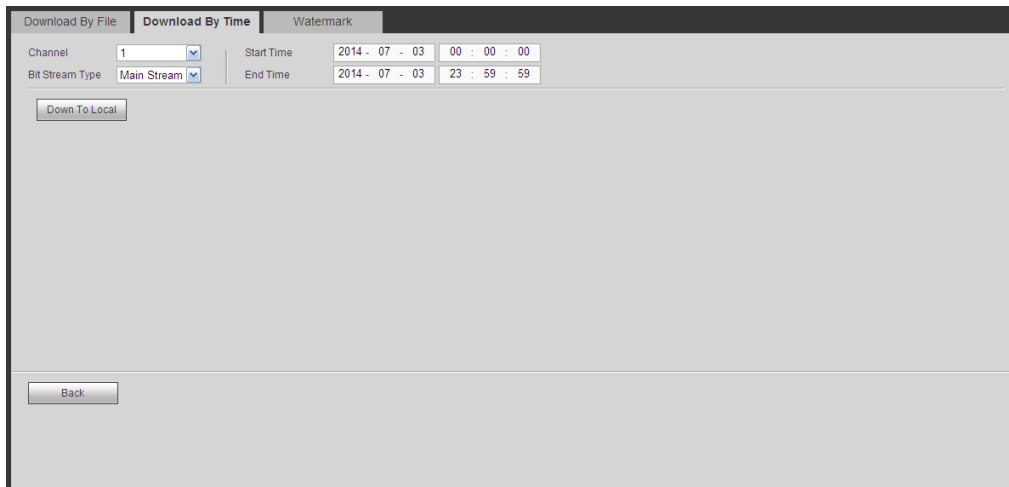

Figure 4-160

### Watermark

Watermark interface is shown as in Figure 4-161. Please select a file and then click Verify button to see the file has been tampered with or not

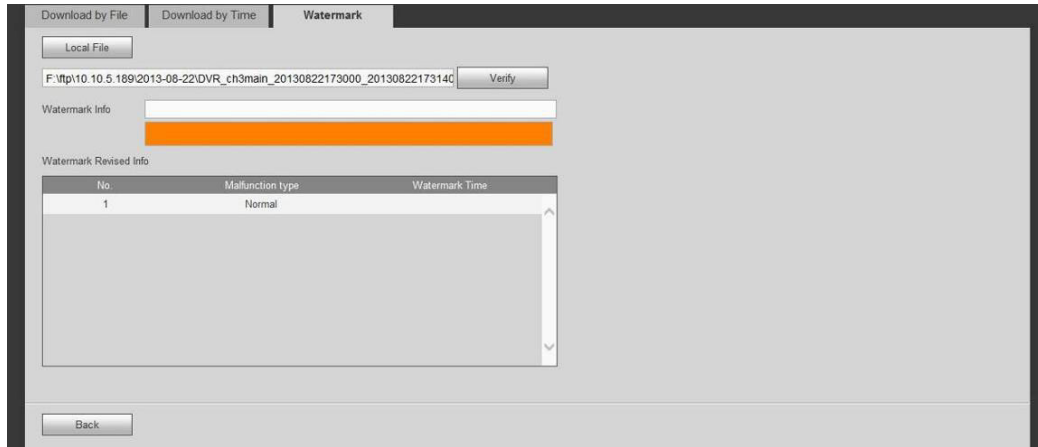

Figure 4-161

#### 4.10.6 Lock file

Check the box to select the record file(s), and then click Lock button, user may lock the file(s). System will not overwrite the locked files. Please note this function is for main stream only.

#### 4.10.7 Unlock file

Click view locks, user may see the following interface. See Figure 4-162.

Select a channel/start time/end time, click search button, user may view the locked files.

Check the box and then click unlock, user may unlock the file.

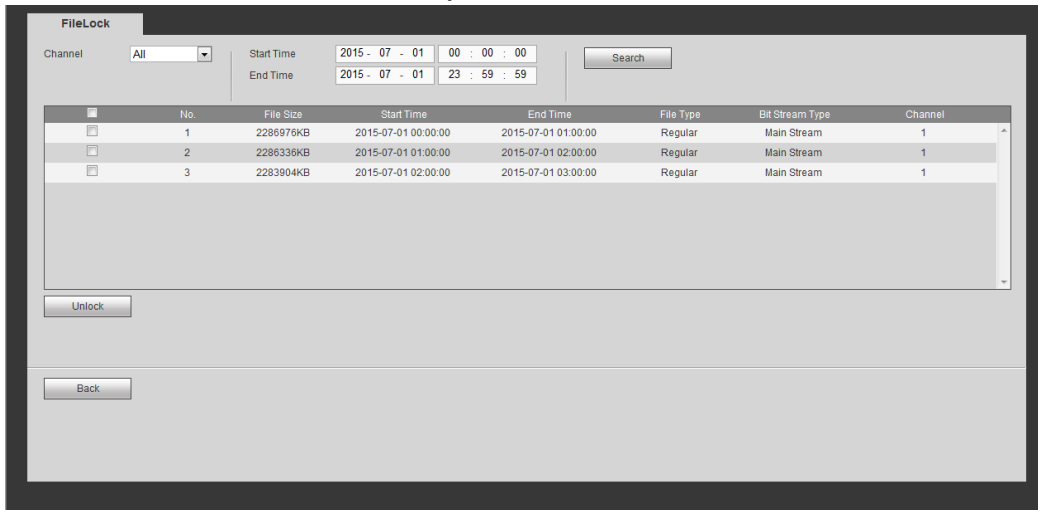

Figure 4-162

### 4.11 Smart Playback

It is to realize the intelligent detect on the playback record.

In the main menu, click smart playback, user may go to the following interface. See Figure 4-163.

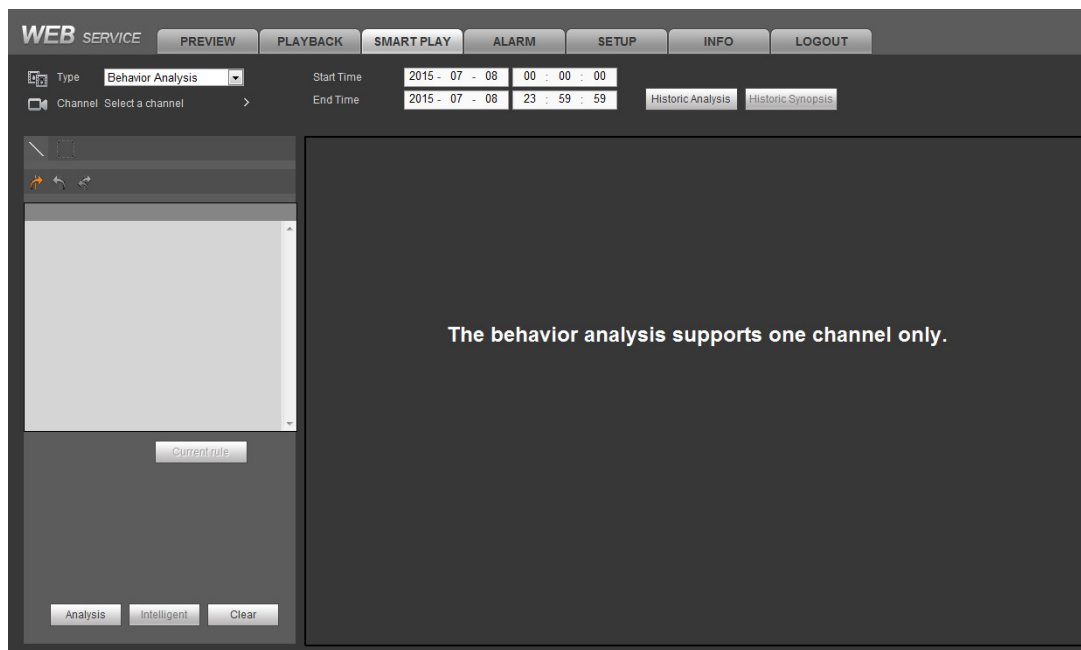

Figure 4-163

#### 4.11.1 Behavior Analysis

It is to search the record of corresponding rule and then playback.

Set a channel number. Please note this function is for 1-channel mode only.

Set the search type as behavior analytics, set channel, start time and end time.

Set detect rule (tripwire/intrusion), and then set detect rule.

##### 4.11.1.1 Tripwire

Click  and then use mouse to draw the rule on the right pane of the interface. Left click mouse to confirm first and then right click mouse to complete drawing. Here user may set rule direction. See Figure 4-164.

- Line1/2/3/4: System supports four tripwires. Each SN stands for one tripwire.
- Direction (A to B/B to A/Both): System can generate an alarm once there is any object crossing in the specified direction.

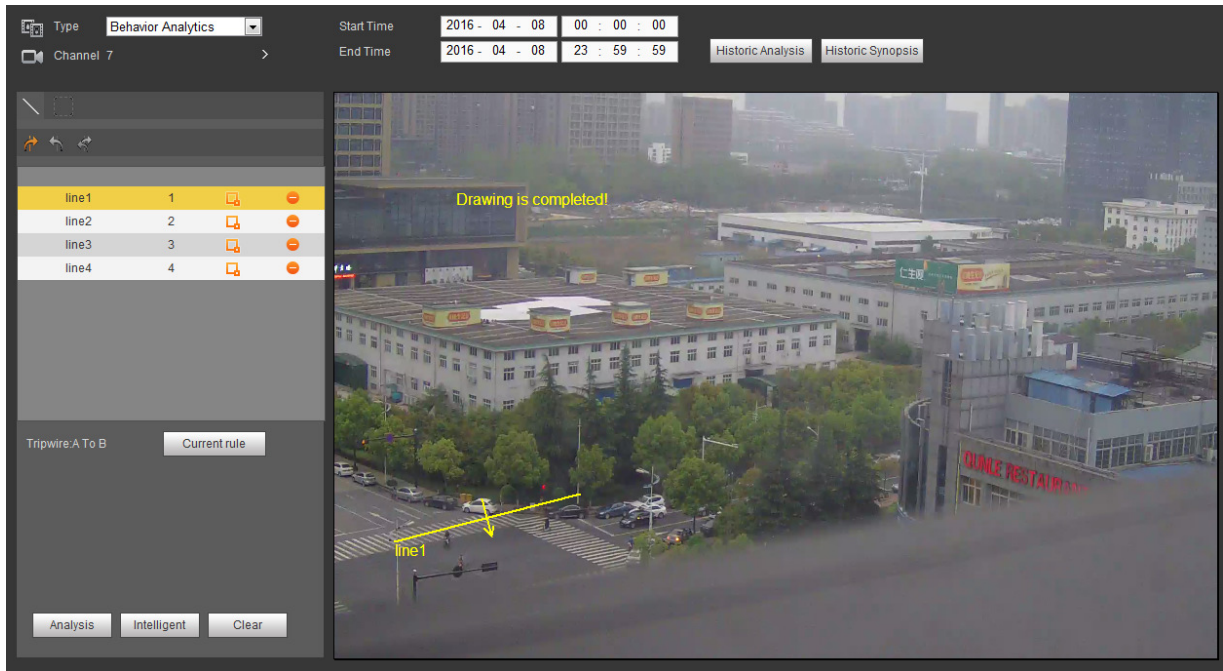





Figure 4-164

#### 4.11.1.2 Intrusion

Click , use mouse to draw the rule on the right pane of the interface. Please note the start position and the end position shall be at the same place. Right click mouse to complete the setup. See Figure 4-165.

- Area1/2/3/4: System supports four zones. Each SN stands for one area.
- Direction (  ): System can generate an alarm once there is any object enter/exit (Or both) the zone.

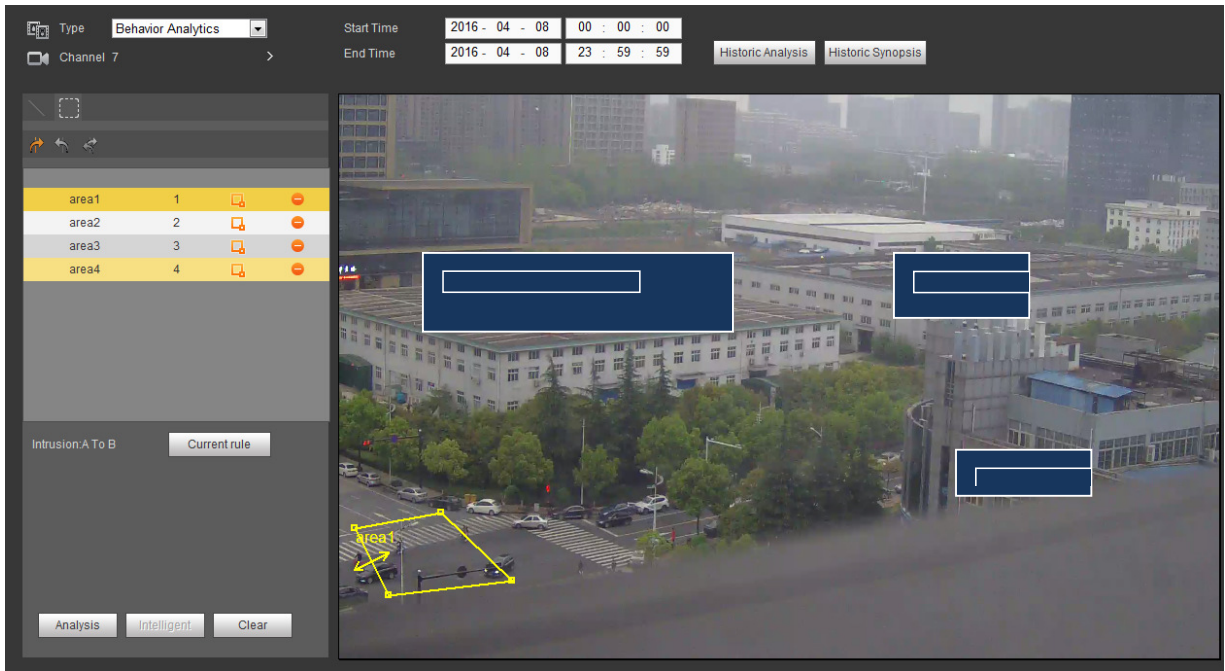

Figure 4-165

**Tips**

Click Current rule button, user may use the rule you set in chapter 4.8.3.3 (Main menu->Setting->Event->Behavior Analytics) to detect.

Click Historic analysis button at the right pane or Analysis button at the bottom of the interface, system begins analyzing, and display the image of the corresponding event. See Figure 4-166.

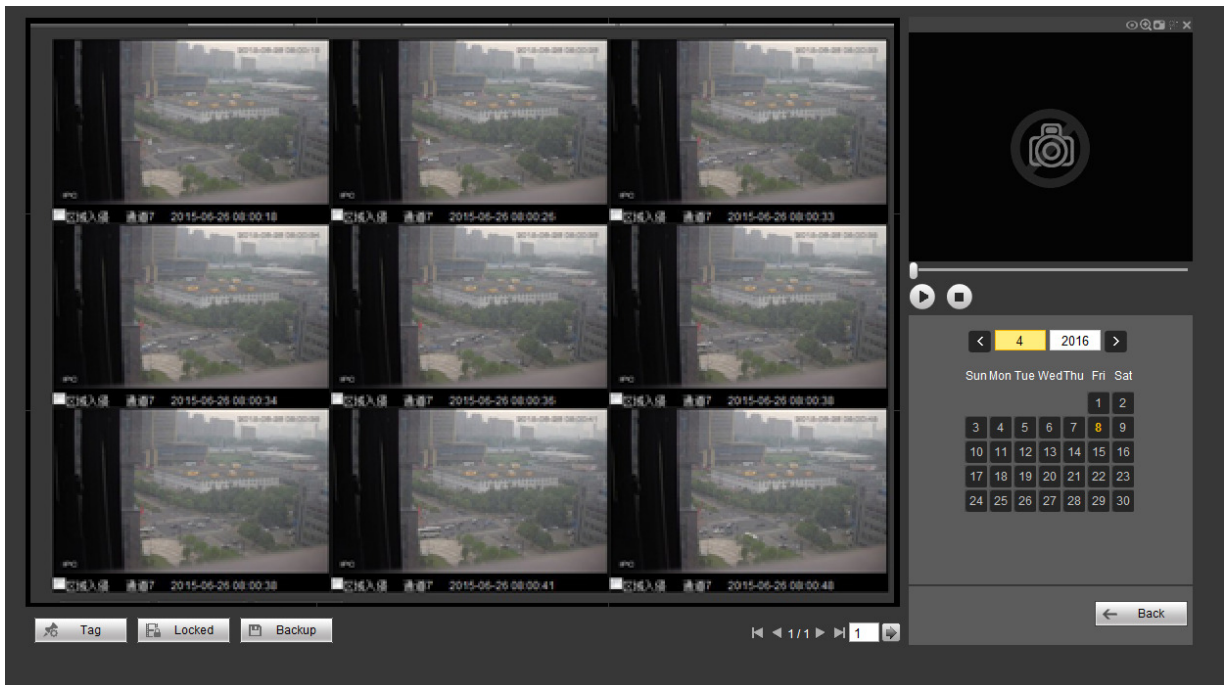
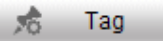
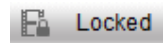
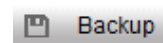

Figure 4-166

Click the image; user may view the record file.

- Select the file and then click  Tag, user may save current file to peripheral device.
- Select the file and then click  Locked, user may lock the file in case it will be overwritten in the future.
- Select the file and then click  Backup, user may mark the time of the detected event.

In smart playback interface (Figure 4-163), click Clear button, user may delete detection and behavior analytics rule(s) of current channel.

#### 4.11.1.3 Face Detect Playback

System can search the record containing the human face and then playback.

##### **Important**

Before you use this function, please make sure current channel has enabled human face detection function. Please refer to chapter 4.8.3.4 (Main menu->Setting->Event->Face Detection) for detailed information.

Set the search type as face detect, set channel, start time and end time.

Click Historic analysis button at the right pane or Analysis button at the bottom of the interface, system begins to search. User may view the event time and image. See Figure 4-167.

Click the image, system begins playback.

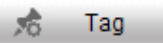
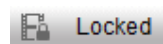
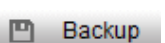
- Select the file and then click  Tag, user may save current file to peripheral device.
- Select the file and then click  Locked, user may lock the file in case it will be overwritten in the future. Select the file and then click  Backup, user may mark the time of the detected event.

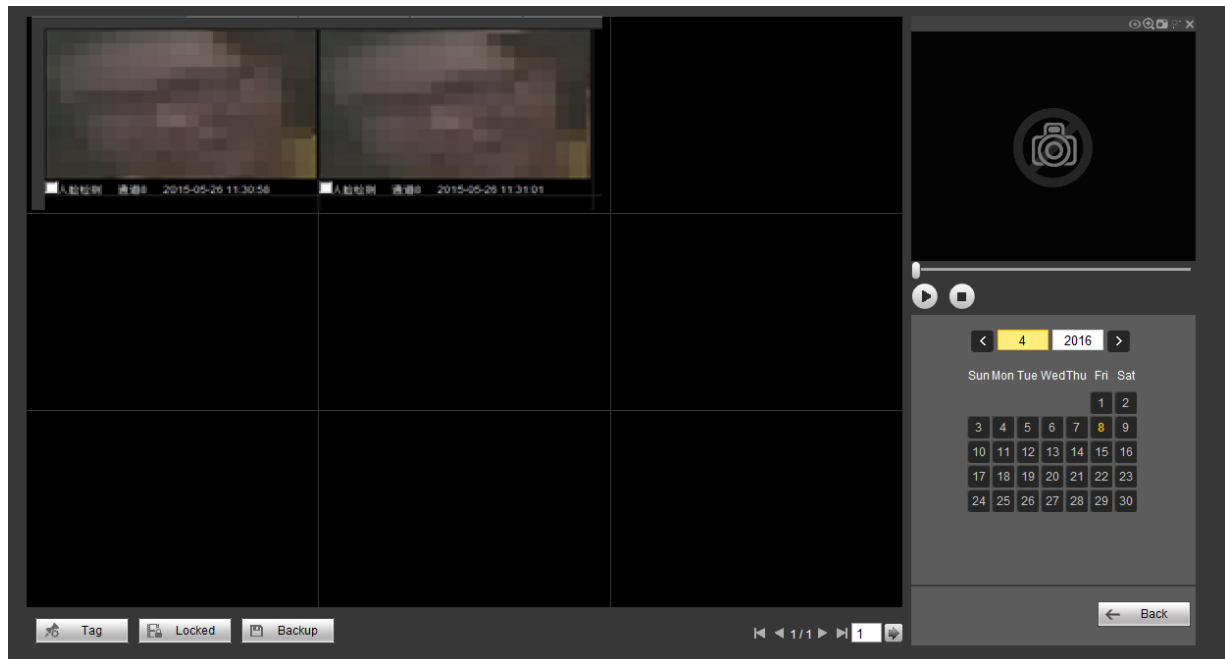

Figure 4-167

#### 4.11.1.4 Video Synopsis

System can analyze the moving object, extract the moving object and merge different moving objects to one common background. In this way, it can display all moving objects and persons in the specified period to one window for you to view.

On smart search interface, select detection type, channel, start time and end time.

Input resolution and synopsis density, click the OK button.

User may view the image after the synopsis process.

Click the green rectangle; user may playback the record at the top right corner of the interface.

#### Tips

Click Historic synopsis, user may view the previous synopsis image.

### 4.12 Alarm

Click alarm function, user may see an interface is shown as Figure 4-168.

Here user may set device alarm type and alarm sound setup (Please make sure you have enabled audio function of corresponding alarm events.).

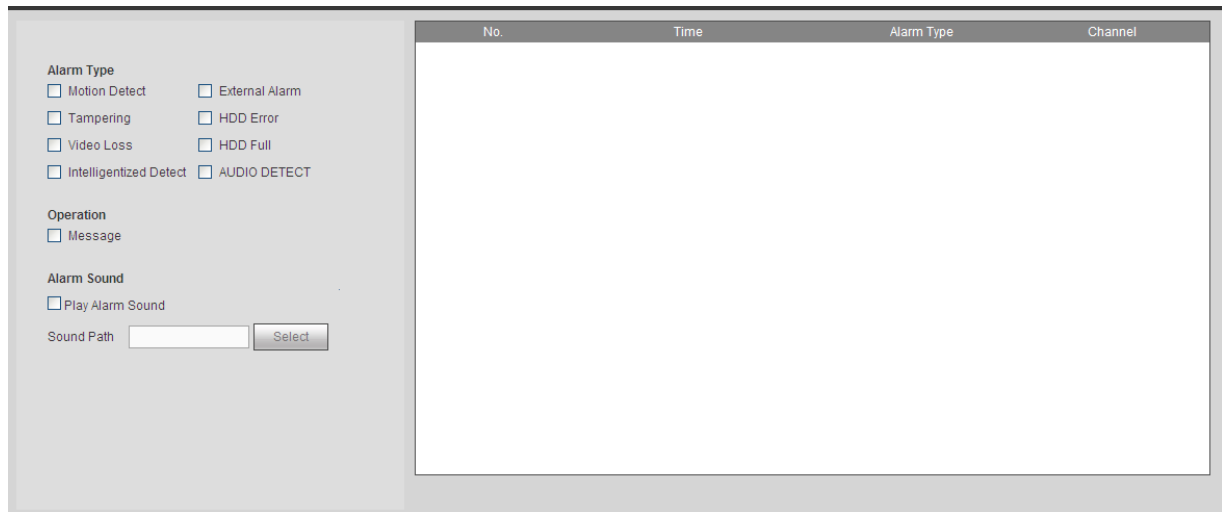

Figure 4-168

Please refer to the following sheet for detailed information.

Type	Parameter	Function
Alarm Type	Video loss	System alarms when video loss occurs.
	Motion detection	System alarms when motion detection alarm occurs.
	Tampering	System alarms when camera is viciously masking.
	Disk full	System alarms when disk is full.
	Disk error	System alarms when disk error occurs.
	External alarm	Alarm input device sends out alarm.
	IPC external alarm	It refers to the on-off signal from the network camera. It can activate the NVR local activation operation.
	IPC offline alarm	System can generate an alarm when the network camera and the NVR are disconnected.

Type	Parameter	Function
Operation	Prompt	Check the box here, system can automatically pops up an alarm icon on the Alarm button in the main interface when there is an alarm.
Alarm Sound	Play alarm sound	System sends out alarm sound when an alarm occurs. User may specify as you wish.
	Sound path	Here user may specify alarm sound file.

### 4.13 Log out

Click log out button, system goes back to log in interface. See Figure 4-169.

You need to input user name and password to login again.

Figure 4-169

### 4.14 Un-install Web Control

User may use web un-install tool “uninstall web.bat” to un-install web control.

**Please note, before you un-installation, please close all web pages, otherwise the un-installation might result in error.**



## Appendix A HDD Capacity Calculation

Calculate total capacity needed by each device according to video recording (video recording type and video file storage time).

Step 1: According to Formula (1) to calculate storage capacity  $q_i$  that is the capacity of each channel needed for each hour, unit Mbyte.

$$q_i = d_i \div 8 \times 3600 \div 1024 \quad (1)$$

In the formula:  $d_i$  means the bit rate, unit Kbit/s

Step 2: After video time requirement is confirmed, according to Formula (2) to calculate the storage capacity  $m_i$ , which is storage of each channel needed unit Mbyte.

$$m_i = q_i \times h_i \times D_i \quad (2)$$

In the formula:

$h_i$  means the recording time for each day (hour)

$D_i$  means number of days for which the video shall be kept

Step 3: According to Formula (3) to calculate total capacity (accumulation)  $q_T$  that is needed for all channels in the device during **scheduled video recording**.

$$q_T = \sum_{i=1}^c m_i \quad (3)$$

In the formula:  $c$  means total number of channels in one device

Step 4: According to Formula (4) to calculate total capacity (accumulation)  $q_T$  that is needed for all channels in device during **alarm video recording (including motion detection)**.

$$q_T = \sum_{i=1}^c m_i \times a\% \quad (4)$$

In the formula:  $a\%$  means alarm occurrence rate

### Note

- **This manual is for reference only. Slight difference may be found in the user interface.**
- **All the designs and software here are subject to change without prior written notice.**
- **All trademarks and registered trademarks are the properties of their respective owners.**
- **If there is any uncertainty or controversy, please refer to the final explanation of us.**
- **Please visit our website or contact your local service engineer for more information.**

Dante Security

Sales@dantesecurity.net

support@dantesecurity.net

www.dantesecurity.net